

STP 21-1-SMCT



HEADQUARTERS  
DEPARTMENT OF THE ARMY

Soldier's Manual of  
Common Tasks  
Skill Level 1



AUGUST 2003

DISTRIBUTIONRESTRICTION: Approvedforpublicrelease;  
distributionisunlimited.





**This publication is available at Army  
Knowledge OnLine ([www.us.army.mil](http://www.us.army.mil)) and  
the General Dennis J. Reimer Training and  
Doctrine Digital Library at  
([www.adtdl.army.mil](http://www.adtdl.army.mil))**



**\*STP 21-1-SMCT**

Soldier Training Publication  
No. 21-1-SMCT

Headquarters  
Department of the Army  
Washington, DC, 31 August 2003

**SOLDIER'S MANUAL OF  
COMMON TASKS  
Skill Level 1  
TABLE OF CONTENTS**

	Page
<b>PREFACE</b> .....	vi
<b>Chapter 1. Introduction</b> .....	1-1
<b>Chapter 2. Training Guide</b> .....	2-1
<b>Chapter 3. Skill Level 1 Tasks</b> .....	3-1
<b>Skill Level 1</b>	
<b>Subject Area 1: Individual Conduct and Laws of War</b>	
181-101-1013 Comply with the Uniform Code of Military Justice (UCMJ).....	3-1
181-105-1001 Comply with the Law of War and the Geneva and Hague Conventions .....	3-16
224-176-1425 Interact with News Media .....	3-38
331-202-1049 Comply with the Requirements of the Code of Conduct .....	3-39
805C-PAD-1245 Support Unit and Family Readiness Through the Army Family Team Building (AFTB) Program .....	3-43
805C-PAD-1391 Comply With the Army's Equal Opportunity and Sexual Harassment Policies .....	3-49
<b>Subject Area 2: First Aid</b>	
081-831-1000 Evaluate a Casualty .....	3-52
081-831-1003 Perform First Aid to Clear an Object Stuck in the Throat of a Conscious Casualty .....	3-57
081-831-1005 Perform First Aid to Prevent or Control Shock .....	3-59
081-831-1007 Perform First Aid for Burns.....	3-61
081-831-1008 Perform First Aid for Heat Injuries.....	3-64

**Distribution Restriction:** Approved for public release; distribution is unlimited.

\*This manual supersedes STP 21-1-SMCT, 1 October 1994.

081-831-1025	Perform First Aid for an Open Abdominal Wound ....	3-67
081-831-1026	Perform First Aid for an Open Chest Wound.....	3-69
081-831-1032	Perform First Aid for Bleeding of an Extremity .....	3-72
081-831-1033	Perform First Aid for an Open Head Wound .....	3-75
081-831-1034	Perform First Aid for a Suspected Fracture.....	3-79
081-831-1042	Perform Mouth-to-Mouth Resuscitation.....	3-83
081-831-1044	Perform First Aid for Nerve Agent Injury .....	3-87
081-831-1045	Perform First Aid for Cold Injuries .....	3-97
081-831-1046	Transport a Casualty.....	3-102
081-831-1053	Practice Individual Preventive Medicine Countermeasures.....	3-110

---

**Subject Area 3: Nuclear, Biological, and Chemical (NBC)**

031-503-1013	Decontaminate Yourself and Individual Equipment Using Chemical Decontaminating Kits .....	3-121
031-503-1015	Protect Yourself from NBC Injury/Contamination with Mission-Oriented Protective Posture (MOPP) Gear .....	3-124
031-503-1017	Respond to Depleted Uranium.....	3-128
031-503-1018	React to Nuclear Hazard/Attack.....	3-130
031-503-1019	React to Chemical or Biological Hazard/Attack.....	3-132
031-503-1035	Protect Yourself from Chemical/Biological Contamination Using Your Assigned Protective Mask .....	3-135
031-503-1036	Maintain Your Assigned Protective Mask.....	3-141
031-503-1037	Detect Chemical Agents Using M8 or M9 Detector Paper .....	3-143

---

**Subject Area 4: Survive [Combat Techniques]**

052-192-1042	Perform Self-Extraction from a Mined Area.....	3-146
052-192-1242	Locate Mine and Booby Trap Indicators by Visual Means .....	3-162
071-326-0502	Move Under Direct Fire .....	3-167
071-326-0503	Move Over, Through, or Around Obstacles (Except Minefields).....	3-176
071-326-0510	React to Indirect Fire While Dismounted.....	3-179
071-326-0511	React to Flares.....	3-180
071-326-0513	Select Temporary Fighting Positions.....	3-182
071-326-3002	React to Indirect Fire While Mounted .....	3-184
071-326-5703	Construct Individual Fighting Positions .....	3-185
071-331-0815	Practice Noise, Light, and Litter Discipline .....	3-195
071-331-1004	Perform Duty as a Guard .....	3-197
071-410-0002	React to Direct Fire While Mounted .....	3-199
071-710-0006	Plan Use of Night Vision Devices.....	3-200
093-401-5040	React to Unexploded Ordnance Hazards.....	3-202
551-88M-0005	Operate a Vehicle in a Convoy.....	3-218

---

**Subject Area 5: Navigate**

071-329-1006	Navigate from One Point on the Ground to Another Point While Dismounted .....	3-224
071-329-1030	Navigate from One Point on the Ground to Another Point While Mounted .....	3-234

---

**Subject Area 6: Communicate**

113-571-1022	Perform Voice Communications.....	3-241
113-600-2001	Communicate Via a Tactical Telephone .....	3-247
113-637-2001	Communicate Via a Tactical Radio in a Secure Net .....	3-249

---

**Subject Area 7: See**

071-331-0804	Perform Surveillance without the Aid of Electronic Devices .....	3-250
071-730-0014	Identify Combat Vehicles .....	3-254

---

**Subject Area 8: Hand Grenades and Land Mines**

071-325-4401	Perform Safety Checks on Hand Grenades .....	3-256
071-325-4407	Employ Hand Grenades.....	3-260
071-325-4425	Employ an M18A1 Claymore Mine.....	3-262

---

**Subject Area 9: M16-Series Rifle**

071-008-0007	Engage Targets with an M16-Series Rifle Using an AN/PAS-13 Series Thermal Weapon Sight .....	3-275
071-311-2025	Maintain an M16-Series Rifle .....	3-277
071-311-2027	Load an M16-Series Rifle .....	3-303
071-311-2028	Unload an M16-Series Rifle .....	3-311
071-315-2308	Engage Targets with an M16-Series Rifle Using a Night Vision Sight AN/PVS-4 .....	3-313

---

**Subject Area 10: M240B Machine Gun**

071-000-0005	Prepare a Range Card for a Machine Gun .....	3-317
071-025-0001	Maintain an M240B Machine Gun.....	3-326
071-025-0003	Load an M240B Machine Gun .....	3-334
071-025-0004	Unload an M240B Machine Gun .....	3-336
071-025-0007	Engage Targets with an M240B Machine Gun.....	3-337

---

**Subject Area 11: M249 Machine Gun**

071-010-0006	Engage Targets with an M249 Machine Gun.....	3-341
071-312-4025	Maintain an M249 Machine Gun .....	3-351
071-312-4027	Load an M249 Machine Gun.....	3-375
071-312-4028	Unload an M249 Machine Gun .....	3-379

---

**Subject Area 12: M60 Machine Gun**

071-312-3025	Maintain an M60 Machine Gun .....	3-381
071-312-3027	Load an M60 Machine Gun.....	3-397

071-312-3028	Unload an M60 Machine Gun .....	3-399
071-312-3031	Engage Targets with an M60 Machine Gun .....	3-401

---

**Subject Area 13: MK19 Machine Gun**

071-030-0001	Maintain an MK19 Machine Gun .....	3-407
071-030-0004	Engage Targets with an MK19 Machine Gun.....	3-431
071-030-0005	Load an MK19 Machine Gun .....	3-440
071-030-0006	Unload an MK19 Machine Gun .....	3-445
071-030-0007	Perform a Function Check on an MK19 Machine Gun .....	3-449

---

**Subject Area 14: Caliber .50 M2 Machine Gun**

071-022-0001	Maintain a Caliber .50 M2 Machine Gun .....	3-451
071-022-0003	Load a Caliber .50 M2 Machine Gun.....	3-487
071-022-0004	Unload a Caliber .50 M2 Machine Gun .....	3-488
071-313-3454	Engage Targets with a Caliber .50 M2 Machine Gun .....	3-490

---

**Subject Area 15: M136 Launcher**

071-054-0001	Prepare an M136 Launcher for Firing .....	3-501
071-054-0002	Restore an M136 Launcher to Carrying Configuration.....	3-507

---

**Subject Area 16: M203 Grenade Launcher**

071-311-2125	Maintain an M203 Grenade Launcher .....	3-509
071-311-2127	Load an M203 Grenade Launcher .....	3-516
071-311-2128	Unload an M203 Grenade Launcher .....	3-518
071-311-2129	Correct Malfunctions of an M203 Grenade Launcher .....	3-519
071-311-2130	Engage Targets with an M203 Grenade Launcher.	3-521

---

**Subject Area 17: M4 Carbine**

071-100-0003	Engage Targets with an M4 or M4A1 Carbine .....	3-528
071-100-0004	Maintain an M4 or M4A1 Carbine.....	3-530

---

**Subject Area 18: 9mm Pistol**

071-004-0001	Maintain an M9 Pistol.....	3-538
071-004-0003	Load an M9 Pistol .....	3-546
071-004-0004	Unload an M9 Pistol .....	3-547
071-004-0006	Engage Targets with an M9 Pistol.....	3-548

---

**Subject Area 19: Crowd Control**

191-376-4121	Use a Riot Baton .....	3-558
191-376-4122	Position Yourself in Riot Control Formations.....	3-568

---

**Subject Area 20: Casualty Reporting and Handling**

101-515-1997	Inter Isolated Remains (After Receiving Authorization).....	3-576
--------------	---	-------

101-515-1998	Evacuate Isolated Remains .....	3-577
101-515-1999	Recover Isolated Remains .....	3-579

---

**Subject Area 21: Defense Measures**

052-191-1361	Camouflage Yourself and Your Individual Equipment.....	3-582
052-191-1362	Camouflage Equipment .....	3-588
191-376-4114	Control Entry to and Exit from a Restricted Area ...	3-591
301-371-1000	Report Intelligence Information .....	3-593
301-371-1050	Implement Operations Security (OPSEC) Measures .....	3-595

<b>Appendix A</b>	<b>Proponent or Agency Codes.....</b>	<b>A-1</b>
-------------------	---------------------------------------	------------

<b>Appendix B</b>	<b>Guide to Forms .....</b>	<b>B-1</b>
-------------------	-----------------------------	------------

<b>Appendix C</b>	<b>Land Navigation Supporting Tasks .....</b>	<b>C-1</b>
-------------------	---	------------

<b>Glossary .....</b>	<b>Glossary-1</b>
-----------------------	-------------------

<b>References .....</b>	<b>References-1</b>
-------------------------	---------------------

## PREFACE

This manual is one of a series of soldier training publications that support individual training. Commanders, trainers, and soldiers will use this manual and STP 21-24-SMCT, *Soldier's Manual of Common Tasks, Skill Levels 2, 3, and 4*, to plan, conduct, sustain, and evaluate individual training of common tasks in units.

This manual contains a common task training plan for skill levels (SL) 1 through 4 and task summaries for SL 1 critical common tasks that support unit wartime missions. This manual is the only authorized source for these common tasks. Task summaries in this manual supersede any common tasks appearing in MOS-specific soldier's manuals.

Training support information, such as reference materials, is also included. Trainers and first-line supervisors should ensure SL 1 soldiers have access to this publication in their work areas, unit learning centers, and unit libraries.

This manual applies to both active and reserve component soldiers.

Unless this manual states otherwise, masculine pronouns do not refer exclusively to men.

The proponent of this publication is the Commander, United States Army Training and Doctrine Command (TRADOC), with the Commander, United States Army Training Support Center (ATSC) designated as the principle publishing, printing and distribution agency. Proponents for the specific tasks are the Army schools and agencies as identified by the school code, listed at appendix A. This code consists of the first three digits of the task identification number. All comments, suggestions, and recommended changes to this publication should be submitted as follows:

Record any comments or questions regarding the task summaries contained in this manual on a DA Form 2028 (*Recommended Changes to Publications and Blank Forms*) and send it to the respective task proponent with information copies forwarded to: Commander, U.S. Army Training and Doctrine Command, ATTN: ATTG-I, Fort Monroe, VA 23651-5000, and Commander, U.S. Army Training Support Center, ATTN: ATIC-ITSC-CM, Fort Eustis, VA 23604-5166.



### **SPECIAL NOTES CONCERNING THE AUGUST 2003 SMCT**

**5" X 7" Format.** Beginning with the August 2003 revisions, both the STP 21-1-SMCT and STP 21-24-SMCT are printed in 5"x7" format, following the very favorable acceptance of previous skill level 1 SMCTs which inaugurated the "pocket-size" manuals. This, however, has precluded incorporating full-size reproducible forms at the end of the books. Instead, a Guide to Forms (Appendix B) is now provided which, in the online versions of the new manuals, contains electronic links to the downloadable, reproducible forms. Where online access is not available, the soldier's unit often has hard copies of the forms, or can obtain them.

**Land navigation skills and knowledge,** for common tasks 071-329-1006, Navigate from One Point on the Ground to Another Point While Dismounted, and 071-329-1030, Navigate from One Point on the Ground to Another Point While Mounted are grouped in Appendix C, identified by the grey-edged pages near the end of this manual.

**Task 052-192-1135, Locate Mines by Probing.** Performance standards for this task are now incorporated into task 052-192-1042, Perform Self-Extraction from a Mined Area. These standards are further updated from the 18 March 03 revision of Locate Mines by Probing.

**Task 071-730-0014, Identify Combat Vehicles.** This task, uniquely, incorporates a Windows-based online option (ROC-V, Recognition of Combat Vehicles) for training and testing soldiers. In addition to teaching thermal and visual identification cues of vehicles and practical use of thermal sensor image controls, the program ensures identification standards are current, irrespective of print date of this manual. Refer to the Evaluation Preparation section of this task for instructions on accessing the ROC-V program.

---

**SPECIAL NOTE FROM THE STAFF  
CONCERNING THE REVISED SMCT**

Experienced trainers will notice that, in addition to the numerous new tasks in the revised SMCT, there are many tasks for which the skill level has been lowered from that in the past. This reflects results from the recent survey of approximately 19,000 enlisted soldiers, their commanders, and senior leaders, to determine who was actually performing certain tasks, and the amount of learning that was actually filtering down in the “one room schoolhouse” of the working Army. When it was established that a significant percentage of soldiers were performing those tasks at skill levels that were above their own, it was decided to lower the task designation, giving trainers—and the Army—the full advantage of accelerated learning at every level. This SMCT, if anything, reflects back to its users a faithfulness to this spirit of Army training from whom it derived, an allegiance and gratitude to the profession and legacy of every United States Army soldier.

Thank you.

United States Army Training and Doctrine Command  
United States Army Training Support Center

---

## Chapter 1

# Introduction to the SMCT System

### 1-1. GENERAL

Training prepares soldiers, leaders, and units to fight and win in combat—the Army's basic mission. As explained in the Army's CAPSTONE training document, FM 7-0 Training the Force, units do not have the time and resources to achieve and sustain proficiency on every possible training task. Commanders must identify the unit's critical wartime tasks. These tasks make up the unit's Mission Essential Task List (METL). Commanders use this list to develop their unit training plan. Noncommissioned Officer (NCO) trainers then plan the individual training that soldiers in the unit need to accomplish the METL. The soldier training publications (STP), also known as soldier's manuals (SMs), provide the critical individual tasks for each military occupational specialty (MOS) that support the unit's full spectrum of missions. The NCO trainer uses the tasks in the SMs to train the soldiers and measure the soldier's proficiency on these unit critical tasks. The manuals provide task performance and evaluation criteria and are the basis for individual training and evaluation in the unit and for task-based evaluation during resident training.

### 1-2. PURPOSE

The Soldier's Manual of Common Tasks (SMCT), Skill Level (SL) I, contains the common tasks that are essential to the Army's ability to win on the modern battlefield. In the event of war, regardless of job or individual MOS, each soldier risks exposure to hostile actions. This manual contains the common tasks that soldiers must be able to perform to fight, survive, and win in combat.

The SMCT provides the commander, NCO trainer or first-line supervisor, and individual soldiers with the information necessary to support integration and sustainment training in their units. This information allows trainers to plan, prepare, train, evaluate, and monitor individual training of common tasks. Using the appropriate mission training plan (MTP), MOS specific STPs, and this manual, will help provide the foundation for an effective unit training plan.

### 1-3. COMMANDER'S RESPONSIBILITIES

The commander at each level develops a unit METL in consultation with the command sergeant major and subordinate commanders. Using the Training Planning Process described in FM 7-0, the commander develops the METL and then determines the level of training needed to attain and maintain proficiency. After determining the necessary training, the commander

develops a strategy to accomplish the required training. The commander also gives his or her trainers the guidance they need to carry out this strategy. Each commander must design a unit training plan that prepares the unit for the full spectrum of operations. Soldiers must develop and sustain proficiency in the critical tasks for their MOS and skill level. The commander's unit training program should provide individual training for all soldiers assigned to the unit and routinely evaluate soldier proficiency. The leader's assessment and the Common Task Test (CTT) are two tools that give the trainer and commander feedback on the status of training for individuals and for the unit. This feedback should also be integrated with collective training such as the MTP and crew drills. The Common Task Training Plan, located in Chapter 2, provides information on where the common tasks are first trained to standard and how often the tasks should be trained to maintain proficiency.

Based on the commander's guidance, individual training in the unit is the responsibility of the NCO trainers. The commander must give the NCO trainer the priorities, resources, and direction needed to carry out training. He or she must also assess the training results of the MTP and other training events, and adjust the training plan accordingly. To develop a training program, we recommend the following seven-step approach:

- Step 1.** Set the objectives for training.
- Step 2.** Plan the resources (personnel, time, funds, facilities, devices, training aids).
- Step 3.** Train the trainers.
- Step 4.** Provide the resources.
- Step 5.** Manage risks, environmental and safety considerations.
- Step 6.** Conduct the training.
- Step 7.** Evaluate the results.

#### **1-4. TRAINER'S RESPONSIBILITIES**

Trainers use the steps below to plan and evaluate training.

**a. *Identify individual training requirements.*** The NCO determines which tasks soldiers need to train based on the commander's training strategy. The unit's training plan, METL, MTP, and the Common Task Training Plan (Chapter 2) are sources for helping the trainer define the individual training needed.

**b. *Plan the training.*** Plan individual training based on the unit's training plan. Be prepared to take advantage of opportunities to conduct individual training ("hip pocket" training).

**c. *Gather the training references and materials.*** The task summaries list references that can assist the trainer in preparing for the training of that

task. Check the Reimer Digital Library to see if any new resources have been added.

**d. *Manage risks and environmental and safety concerns.*** Assess the risks involved in training a specific task under the conditions current at the time you are scheduled to train and implement controls, if necessary, to lessen the risk level. Ensure that your training preparation takes into account those cautions, warnings, and dangers associated with each task as well as environmental and safety concerns.

**e. *Train each soldier.*** Show the soldier how to do the task to standard and explain step-by-step how to do the task. Give each soldier a chance to practice the task step-by-step.

**f. *Emphasize training in Mission-Oriented Protective Posture (MOPP) Level 4 clothing.*** Soldiers have difficulty performing even very simple tasks in a nuclear/chemical environment. The combat effectiveness of the soldier and the unit can degrade quickly when trying to perform in MOPP 4. Practice is the best way to improve performance. The trainer is responsible for training and evaluating soldiers in MOPP 4 so that they are able to perform critical tasks to standards within a nuclear/chemical environment.

**g. *Check each soldier.*** Evaluate how well each soldier performs the tasks in this manual. Conduct these evaluations during individual training sessions or while evaluating individual proficiency during the conduct of unit collective tasks. This manual provides a training and evaluation guide for each task to enhance the trainer's ability to conduct year-round, hands-on evaluations of tasks critical to the unit's mission. Use the information in the Common Task Training Plan as a guide to determine how often to train the soldier on each task to maintain proficiency.

**h. *Record the results.*** Use the leader book referred to in FM 7-10 to record task performance. This gives the leader total flexibility on the method of recording training. The trainer may use DA Form 5164-R (Hands-on Evaluation) and DA Form 5165-R (Field Expedient Squad Book) as part of the leader book. These forms are optional and locally reproducible. More information on the use of these forms is provided in Appendix B of this manual.

**i. *Retrain and evaluate.*** Work with each soldier until the individual performs the task to standard. Well-planned, integrated training increases the professional competence of each soldier and contributes to the development of an efficient unit. The NCO or first-line supervisor is a vital link in the conduct of training.

#### **1-5. SOLDIER'S RESPONSIBILITIES**

Each soldier must be able to perform the individual tasks that the first-line supervisor has identified based on the unit's METL. The soldier must perform the task to the standard listed in the SMCT. If a soldier has a

question about how to do a task, or which tasks in this manual he or she must perform, it is the soldier's responsibility to go to the first-line supervisor for clarification. The first-line supervisor knows how to perform each task or can direct the soldier to the appropriate training materials. Additionally, each soldier should—

a. Know the training progression for both the common critical tasks and their MOS specific critical tasks for their skill level. Lists of the critical tasks can be found in Chapter 2 of this manual (for common tasks) and the STP for their specific MOS (MOS specific tasks).

b. Check the Reimer Digital Library for new training materials to support self-development either to maintain previously trained tasks or to learn new tasks.

#### **1-6. TASK SUMMARIES**

Task summaries document the performance requirements of a critical common task. They provide the soldier and the trainer with the information necessary to evaluate critical tasks. The format for the task summaries is—

a. *Task Title.* The task title identifies the action to be performed.

b. *Task Number.* A 10-digit number that identifies each task. The first three digits of the number represent the proponent code for that task. (A list of the proponent codes is given in Appendix A.) Include the entire 10-digit task number, along with the task title, in any correspondence relating to the task.

c. *Conditions.* The task conditions identify all the equipment, tools, materials, references, job aids, and supporting personnel that the soldier needs to perform the task. This section identifies any environmental conditions that can alter task performance such as visibility, temperature, or wind. This section also identifies any specific cues or events (for example, a chemical attack or identification of an unexploded ordnance hazard) that trigger task performance.

d. *Standard.* A task standard specifies the requirements for task performance by indicating how well, completely, or accurately a product must be produced, a process must be performed, or both. Standards are described in terms of accuracy, tolerances, completeness, format, clarity, number of errors, quantity, sequence, or speed of performance.

e. *Training and Evaluation Guide.* This section has two parts. The first part, Performance Steps, lists the individual steps that the soldier must complete to perform the task. The second part is the Performance Evaluation Guide. This provides guidance on how to evaluate a soldier's performance of the task. It is composed of three subsections. The Evaluation Preparation subsection identifies special setup procedures and, if required, instructions for evaluating the task performance. Sometimes the conditions and standard must be modified so that the task can be evaluated

in a situation that does not exactly duplicate actual field performance. This subsection may also include instructions that the evaluator should give to the soldier before the performance test. The Performance Measures subsection identifies the criteria for acceptable task performance. The soldier is rated (GO/NO GO) on how well he or she performs specific actions or produces specific products. As indicated in the Evaluation Guidance subsection, the soldier must score a GO on all or specified performance measures to receive a GO on the task.

f. *References.* This section identifies references that provide more detailed and thorough explanations of task performance requirements than that given in the task summary description. This section identifies resources the soldier can use to improve or maintain performance.

Additionally, task summaries can include safety statements, environmental considerations, and notes. Safety statements (danger, warning, caution) alert users to the possibility of immediate death, personal injury, or damage to equipment. Notes provide additional information to support task performance.

#### **1-7. EVALUATING TASK PERFORMANCE**

Trainers need to keep the following points in mind when preparing to evaluate their soldiers—

- a. Review the performance measures to become familiar with the criteria on which the soldier will be scored.
- b. Ensure that all necessary equipment and clothing needed for proper performance of the job are on hand at the training site. Don't forget to include safety equipment.
- c. Prepare the test site according to the conditions section of the task summary. Some tasks contain special evaluation preparation instructions. These instructions tell the trainer what modifications must be made to the job conditions to evaluate the task. Reset the site to its original condition after evaluating each soldier to ensure that the conditions are the same for each soldier.
- d. Advise each soldier of any special guidance that appears in the Evaluation Preparation section of the task summary before evaluating.
- e. Score each soldier based on the information in the Performance Measures and Evaluation Guidance sections.
- f. Record the date and task performance score ("GO" or "NO GO") in the Leader Book.

## **1-8. TRAINING TIPS FOR TRAINERS**

### **a. Prepare yourself:**

(1) Get training guidance from your chain of command on when to train, which soldiers to train, the availability of resources, and a training site.

(2) Get task conditions and standards from the task summary in this manual.

(3) Ensure that you can do the task. Review the task summary and the references in the reference section. Practice doing the task or, if necessary, have someone train you on the task.

### **b. Prepare the resources:**

(1) Obtain the required resources as identified in the conditions statement for each task and/or modified in the Training and Evaluation Guide.

(2) Gather the equipment and ensure that it is operational.

(3) Prepare a training outline consisting of informal notes on what you want to cover during your training session.

(4) Practice your training presentation.

(5) Coordinate for the use of training aids and devices.

(6) Prepare the training site using the conditions statement as modified in the Training and Evaluation Guide.

### **c. Prepare the soldiers:**

(1) Tell the soldier what task to do and how well it must be done. Refer to the task standard and the performance measures for the task, as appropriate.

(2) Caution soldiers about safety, environment, and security considerations.

(3) Provide any necessary training on basic skills that soldiers must have before they can be trained on the task.

(4) Test each soldier to determine who needs training in what areas by having the soldier perform the task.

### **d. Train soldiers who fail the initial test:**

(1) Demonstrate how to do the task or the specific performance steps to those soldiers who could not perform to standard. Have the soldiers study the appropriate training materials.

(2) Have the soldiers practice the task until they can perform it to standard.

(3) After remedial training, retest each soldier who did not initially pass the performance test.



(4) Provide feedback to those soldiers who fail to perform to the SMCT standards, and have them continue to practice until they can perform to the SMCT standards.

(5) Record the results in the Leader Book.

**1-9. TRAINING SUPPORT: THIS MANUAL INCLUDES THE FOLLOWING THAT PROVIDE ADDITIONAL TRAINING SUPPORT INFORMATION.**

a. Appendix A - Proponent School and Agency Codes guide, lists the task proponents and agency codes (first three digits of the task number) with addresses for submitting comments concerning specific tasks in this manual.

b. Appendix B - Guide to Forms, explains the use of various SMCT training and evaluation forms and, in the online version of this manual, provides links to the forms.

c. Appendix C - Land Navigation Skills and Knowledge, provides additional training support related to the two land navigation tasks in Subject Area 5 (Navigate).

d. Glossary - The Glossary section lists abbreviations and acronyms and their definitions.

e. References - The Reference section lists all reference materials cited in the task summaries by type, identification number, and title.

**Note:** Combine training on the individual tasks contained in this manual with the collective tasks contained in the MTP. Ensure that the necessary safety equipment and clothing needed for proper performance of the job are on hand at the training site.



**Chapter 2**  
**Training Guide**

**2-1. COMMON TASK TRAINING PLAN**

The Common Task Training Plan provides information to help the trainer plan, prepare, train, evaluate, and monitor individual training in units. It lists, by general subject area and skill level, the critical common tasks soldiers must perform, the initial training location, and a suggested frequency of training. The training location column uses brevity codes to indicate where the task is first taught to standards. If the task is taught in the unit the word "UNIT" appears in this column. "SD" indicates tasks trained via self-development media. If it is taught in the training base, the brevity code (BCT, OSUT, AIT) of the resident course appears. Brevity codes and resident courses are listed below.

ANCOC	Advanced NCO Course
BNCOC	Basic NCO Course
PLDC	Primary Leadership Development Course
BCT	Basic Combat Training
OSUT	One Station Unit Training
AIT	Advanced Individual Training
UNIT	Trained in/by the Unit
SD	Self-Development Training

The sustainment training column lists how often (frequency) soldiers should train on the task to ensure they maintain their proficiency. This information is not a requirement, but rather a guide the commander can use to develop a comprehensive unit training plan. The commander, with the unit trainers, is in the best position to determine on which tasks and how often soldiers need training to maintain unit readiness.

<b>Frequency Codes</b>	
AN	Annually
SA	Semi-Annually
QT	Quarterly

<b>Common Task Training Plan</b>			
<b>Task Number</b>	<b>Title</b>	<b>Training Location</b>	<b>Sustainment Training Frequency</b>
<b>Skill Level 1</b>			
<b>Subject Area 1. Individual Conduct and Laws of War</b>			
<b>181-101-1013</b>	Comply with the Uniform Code of Military Justice (UCMJ)	BCT/OSUT	AN
<b>181-105-1001</b>	Comply with the Law of War and the Geneva and Hague Conventions	BCT/OSUT	AN
<b>224-176-1425</b>	Interact with News Media	BCT/OSUT	AN
<b>331-202-1049</b>	Comply with the Requirements of the Code of Conduct	BCT/OSUT	AN
<b>805C-PAD-1245</b>	Support Unit and Family Readiness Through the Army Family Team Building (AFTB) Program	BCT/OSUT	AN
<b>805C-PAD-1391</b>	Comply with the Army's Equal Opportunity and Sexual Harassment Policies	BCT/OSUT	AN
<b>Subject Area 2. First Aid</b>			
<b>081-831-1000</b>	Evaluate a Casualty	BCT/OSUT	AN
<b>081-831-1003</b>	Perform First Aid to Clear an Object Stuck in the Throat of a Conscious Casualty	BCT/OSUT	AN
<b>081-831-1005</b>	Perform First Aid to Prevent or Control Shock	BCT/OSUT	AN
<b>081-831-1007</b>	Perform First Aid for Burns	BCT/OSUT	AN

<b>Common Task Training Plan</b>			
<b>Task Number</b>	<b>Title</b>	<b>Training Location</b>	<b>Sustainment Training Frequency</b>
081-831-1008	Perform First Aid for Heat Injuries	UNIT	AN
081-831-1025	Perform First Aid for an Open Abdominal Wound	UNIT	AN
081-831-1026	Perform First Aid for an Open Chest Wound	UNIT	AN
081-831-1032	Perform First Aid for Bleeding of an Extremity	BCT/OSUT	AN
081-831-1033	Perform First Aid for an Open Head Wound	BCT/OSUT	AN
081-831-1034	Perform First Aid for a Suspected Fracture	BCT/OSUT	AN
081-831-1042	Perform Mouth-to-Mouth Resuscitation	BCT/OSUT	SA
081-831-1044	Perform First Aid for Nerve Agent Injury	BCT/OSUT	QT
081-831-1045	Perform First Aid for Cold Injuries	UNIT	AN
081-831-1046	Transport a Casualty	BCT/OSUT	AN
081-831-1053	Practice Individual Preventive Medicine Countermeasures	BCT/OSUT	SA
<b>Subject Area 3. Nuclear, Biological, and Chemical (NBC)</b>			
031-503-1013	Decontaminate Yourself and Individual Equipment Using Chemical Decontaminating Kits	BCT/OSUT	AN

<b>Common Task Training Plan</b>			
<b>Task Number</b>	<b>Title</b>	<b>Training Location</b>	<b>Sustainment Training Frequency</b>
<b>031-503-1015</b>	Protect Yourself from NBC Injury/Contamination with Mission-Oriented Protective Posture (MOPP) Gear	BCT/OSUT	AN
<b>031-503-1017</b>	Respond to Depleted Uranium	BCT/OSUT	AN
<b>031-503-1018</b>	React to Nuclear Hazard/Attack	BCT/OSUT	AN
<b>031-503-1019</b>	React to Chemical or Biological Hazard/Attack	BCT/OSUT	AN
<b>031-503-1035</b>	Protect Yourself from Chemical/Biological Contamination Using Your Assigned Protective Mask	BCT/OSUT	AN
<b>031-503-1036</b>	Maintain Your Assigned Protective Mask	BCT/OSUT	AN
<b>031-503-1037</b>	Detect Chemical Agents Using M8 or M9 Detector Paper	BCT/OSUT	AN
<b>Subject Area 4. Survive (Combat Techniques)</b>			
<b>052-192-1042</b>	Perform Self-Extraction from a Mined Area	AIT	QT
<b>052-192-1242</b>	Locate Mine and Booby Trap Indicators by Visual Means	AIT	AN
<b>071-326-0502</b>	Move Under Direct Fire	BCT/OSUT	SA
<b>071-326-0503</b>	Move Over, Through, or Around Obstacles (Except Minefields)	BCT/OSUT	SA

<b>Common Task Training Plan</b>			
<b>Task Number</b>	<b>Title</b>	<b>Training Location</b>	<b>Sustainment Training Frequency</b>
071-326-0510	React to Indirect Fire While Dismounted	BCT/OSUT	SA
071-326-0511	React to Flares	BCT/OSUT	SA
071-326-0513	Select Temporary Fighting Positions	BCT/OSUT	SA
071-326-3002	React to Indirect Fire While Mounted	UNIT	AN
071-326-5703	Construct Individual Fighting Positions	BCT/OSUT	SA
071-331-0815	Practice Noise, Light, and Litter Discipline	BCT/OSUT	SA
071-331-1004	Perform Duty as a Guard	BCT/OSUT	AN
071-410-0002	React to Direct Fire While Mounted	UNIT	AN
071-710-0006	Plan Use of Night Vision Devices	UNIT	SA
093-401-5040	React to Unexploded Ordnance Hazards	UNIT	SA
551-88M-0005	Operate a Vehicle in a Convoy	UNIT	SA
<b>Subject Area 5. Navigate</b>			
071-329-1006	Navigate from One Point on the Ground to Another Point While Dismounted	BCT/OSUT	SA
071-329-1030	Navigate from One Point on the Ground to Another Point While Mounted	UNIT	SA

<b>Common Task Training Plan</b>			
<b>Task Number</b>	<b>Title</b>	<b>Training Location</b>	<b>Sustainment Training Frequency</b>
<b>Subject Area 6. Communicate</b>			
113-571-1022	Perform Voice Communications	BCT/OSUT	SA
113-600-2001	Communicate Via a Tactical Telephone	BCT/OSUT	AN
113-637-2001	Communicate Via a Tactical Radio in a Secure Net	BCT/OSUT	AN
<b>Subject Area 7. See</b>			
071-331-0804	Perform Surveillance without the Aid of Electronic Devices	UNIT	SA
071-730-0014	Identify Combat Vehicles	UNIT	SA
<b>Subject Area 8. Hand Grenades and Land Mines</b>			
071-325-4401	Perform Safety Checks on Hand Grenades	BCT/OSUT	SA
071-325-4407	Employ Hand Grenades	BCT/OSUT	SA
071-325-4425	Employ an M18A1 Claymore Mine	BCT/OSUT	QT
<b>Subject Area 9. M16-Series Rifle</b>			
071-008-0007	Engage Targets with an M16-Series Rifle Using an AN/PAS-13 Series Thermal Weapon Sight	BCT/OSUT	AN
071-311-2025	Maintain an M16-Series Rifle	BCT/OSUT	SA
071-311-2027	Load an M16-Series Rifle	BCT/OSUT	SA



<b>Common Task Training Plan</b>			
<b>Task Number</b>	<b>Title</b>	<b>Training Location</b>	<b>Sustainment Training Frequency</b>
071-311-2028	Unload an M16-Series Rifle	BCT/OSUT	SA
071-315-2308	Engage Targets with an M16-Series Rifle Using a Night Vision Sight AN/PVS-4	BCT/OSUT	QT
<b>Subject Area 10. M240B Machine Gun</b>			
071-000-0005	Prepare a Range Card for a Machine Gun	UNIT	SA
071-025-0001	Maintain an M240B Machine Gun	AIT	QT
071-025-0003	Load an M240B Machine Gun	AIT	QT
071-025-0004	Unload an M240B Machine Gun	AIT	QT
071-025-0007	Engage Targets with an M240B Machine Gun	AIT	QT
<b>Subject Area 11. M249 Machine Gun</b>			
071-010-0006	Engage Targets with an M249 Machine Gun	BCT/OSUT	AN
071-312-4025	Maintain an M249 Machine Gun	BCT/OSUT	QT
071-312-4027	Load an M249 Machine Gun	BCT/OSUT	AN
071-312-4028	Unload an M249 Machine Gun	BCT/OSUT	AN
<b>Subject Area 12. M60 Machine Gun</b>			
071-312-3025	Maintain an M60 Machine Gun	UNIT	SA

<b>Common Task Training Plan</b>			
<b>Task Number</b>	<b>Title</b>	<b>Training Location</b>	<b>Sustainment Training Frequency</b>
071-312-3027	Load an M60 Machine Gun	UNIT	SA
071-312-3028	Unload an M60 Machine Gun	UNIT	SA
071-312-3031	Engage Targets with an M60 Machine Gun	UNIT	SA
<b>Subject Area 13. MK19 Machine Gun</b>			
071-030-0001	Maintain an MK19 Machine Gun	UNIT	AN
071-030-0004	Engage Targets with an MK19 Machine Gun	UNIT	AN
071-030-0005	Load an MK19 Machine Gun	UNIT	AN
071-030-0006	Unload an MK19 Machine Gun	UNIT	AN
071-030-0007	Perform a Function Check on an MK19 Machine Gun	UNIT	AN
<b>Subject Area 14. Caliber .50 M2 Machine Gun</b>			
071-022-0001	Maintain a Caliber .50 M2 Machine Gun	UNIT	QT
071-022-0003	Load a Caliber .50 M2 Machine Gun	UNIT	QT
071-022-0004	Unload a Caliber .50 M2 Machine Gun	UNIT	QT
071-313-3454	Engage Targets with a Caliber .50 M2 Machine Gun	UNIT	QT

<b>Common Task Training Plan</b>			
<b>Task Number</b>	<b>Title</b>	<b>Training Location</b>	<b>Sustainment Training Frequency</b>
<b>Subject Area 15. M136 Launcher</b>			
071-054-0001	Prepare an M136 Launcher for Firing	BCT/OSUT	AN
071-054-0002	Restore an M136 Launcher to Carrying Configuration	BCT/OSUT	AN
<b>Subject Area 16. M203 Grenade Launcher</b>			
071-311-2125	Maintain an M203 Grenade Launcher	BCT/OSUT	QT
071-311-2127	Load an M203 Grenade Launcher	BCT/OSUT	QT
071-311-2128	Unload an M203 Grenade Launcher	BCT/OSUT	QT
071-311-2129	Correct Malfunctions of an M203 Grenade Launcher	BCT/OSUT	QT
071-311-2130	Engage Targets with an M203 Grenade Launcher	BCT/OSUT	QT
<b>Subject Area 17. M4 Carbine</b>			
071-100-0003	Engage Targets with an M4 or M4A1 Carbine	UNIT	AN
071-100-0004	Maintain an M4 or M4A1 Carbine	UNIT	AN
<b>Subject Area 18. 9-mm Pistol</b>			
071-004-0001	Maintain an M9 Pistol	UNIT	AN
071-004-0003	Load an M9 Pistol	UNIT	AN
071-004-0004	Unload an M9 Pistol	UNIT	AN
071-004-0006	Engage Targets with an M9 Pistol	UNIT	AN

<b>Common Task Training Plan</b>			
<b>Task Number</b>	<b>Title</b>	<b>Training Location</b>	<b>Sustainment Training Frequency</b>
<b>Subject Area 19. Crowd Control</b>			
191-376-4121	Use a Riot Baton	BCT/OSUT	QT
191-376-4122	Position Yourself in Riot Control Formations	BCT/OSUT	QT
<b>Subject Area 20. Casualty Reporting and Handling</b>			
101-515-1997	Inter Isolated Remains (After Receiving Authorization)	BCT/OSUT	SA
101-515-1998	Evacuate Isolated Remains	BCT/OSUT	SA
101-515-1999	Recover Isolated Remains	BCT/OSUT	SA
<b>Subject Area 21. Defense Measures</b>			
052-191-1361	Camouflage Yourself and Your Individual Equipment	BCT/OSUT	QT
052-191-1362	Camouflage Equipment	UNIT	SA
191-376-4114	Control Entry to and Exit from a Restricted Area	BCT/OSUT	SA
301-371-1000	Report Intelligence Information	BCT/OSUT	AN
301-371-1050	Implement Operations Security (OPSEC) Measures	UNIT	AN

<b>Common Task Training Plan</b>			
<i>Task Number</i>	<i>Title</i>	<i>Training Location</i>	<i>Sustainment Training Frequency</i>
<b>Skill Level 2</b>			
<b>Subject Area 1. Individual Conduct and Laws of War</b>			
<b>181-101-2023</b>	Enforce the Uniform Code of Military Justice (UCMJ)	PLDC	AN
<b>181-105-2001</b>	Enforce the Law of War and the Geneva and Hague Conventions	UNIT	AN
<b>181-105-2002</b>	Conduct Combat Operations According to the Law of War	UNIT	AN
<b>224-176-2426</b>	Enforce Compliance with Media Ground Rules	UNIT	SA
<b>331-202-1050</b>	Enforce Compliance with the Code of Conduct	UNIT	AN
<b>805C-PAD-2503</b>	Enforce Compliance with the Army's Equal Opportunity and Sexual Harassment Policies	PLDC	QT
<b>Subject Area 2. First Aid</b>			
<b>081-831-0101</b>	Request Medical Evacuation	PLDC	AN
<b>081-831-1054</b>	Evacuate Casualties	PLDC	SA
<b>081-831-9000</b>	Implement Preventive Medicine Measures (PMM)	PLDC	SA

<b>Common Task Training Plan</b>			
<b>Task Number</b>	<b>Title</b>	<b>Training Location</b>	<b>Sustainment Training Frequency</b>
<b>Subject Area 3. Nuclear, Biological, and Chemical (NBC)</b>			
<b>031-503-1023</b>	Protect Yourself from Nuclear, Biological, and Chemical (NBC) Injury/Contamination When Changing Mission-Oriented Protective Posture (MOPP) Gear	UNIT	SA
<b>031-503-2001</b>	Identify Chemical Agents Using M256-Series Chemical Agent Detector Kit	UNIT	SA
<b>031-503-2023</b>	Measure Radiation Dose Rate and Total Dose	UNIT	SA
<b>031-503-3002</b>	Conduct Unmasking Procedures	UNIT	SA
<b>031-503-3004</b>	Supervise the Crossing of a Contaminated Area	UNIT	SA
<b>031-503-3005</b>	Submit an NBC 1 Report	UNIT	SA
<b>031-503-3008</b>	Implement Mission-Oriented Protective Posture (MOPP)	UNIT	SA
<b>031-503-3010</b>	Supervise the Employment of Nuclear, Biological, and Chemical (NBC) Markers	UNIT	AN

<b>Common Task Training Plan</b>			
<b>Task Number</b>	<b>Title</b>	<b>Training Location</b>	<b>Sustainment Training Frequency</b>
<b>031-503-4002</b>	Supervise Unit Preparation for a Nuclear, Biological, and Chemical (NBC) Attack	UNIT	AN
<b>031-506-1053</b>	Report NBC Information Using NBC 4 Report	UNIT	SA
<b>031-506-2061</b>	Conduct a Mask Fit Test	UNIT	QT
<b>Subject Area 4. Survive (Combat Techniques)</b>			
<b>061-283-6003</b>	Adjust Indirect Fire	UNIT	QT
<b>071-326-0608</b>	Use Visual Signaling Techniques	PLDC	SA
<b>071-326-5704</b>	Supervise Construction of a Fighting Position	PLDC	AN
<b>071-326-5705</b>	Establish an Observation Post	PLDC	AN
<b>Subject Area 5. Navigate</b>			
<b>071-329-1019</b>	Use a Map Overlay	UNIT	QT
<b>Subject Area 20. Casualty Reporting and Handling</b>			
<b>805C-PAD-2060</b>	Report Casualties	UNIT	SA
<b>Subject Area 21. Defense Measures</b>			
<b>071-430-0002</b>	Conduct a Defense by a Squad	PLDC	SA
<b>Subject Area 22. Unit Operations</b>			
<b>071-326-5502</b>	Issue a Fragmentary Order	PLDC	QT

<b>Common Task Training Plan</b>			
<b>Task Number</b>	<b>Title</b>	<b>Training Location</b>	<b>Sustainment Training Frequency</b>
<b>071-326-5503</b>	Issue a Warning Order	PLDC	QT
<b>551-88N-0002</b>	Prepare for Unit Move	UNIT	QT
<b>Subject Area 23. Security and Control</b>			
<b>301-371-1200</b>	Process Captured Materiel	UNIT	AN
<b>Subject Area 25. Equipment Checks</b>			
<b>091-CLT-4029</b>	Supervise Preventive Maintenance Checks and Services (PMCS)	PLDC	QT
<b>101-92Y-0003</b>	Enforce Compliance with Supply Discipline Procedures	PLDC	SA
<b>101-92Y-0004</b>	Enforce Property Accountability Policies	PLDC	SA
<b>101-92Y-0005</b>	Enforce Compliance with Property Accountability Policies	PLDC	SA
<b>101-92Y-0006</b>	Inspect Equipment for Accountability, Cleanliness, and Serviceability	UNIT	QT
<b>Subject Area 27. Risk Management</b>			
<b>850-001-2000</b>	Employ Accident Prevention Measures and Risk Management Process	PLDC	QT



<b>Common Task Training Plan</b>			
<b>Task Number</b>	<b>Title</b>	<b>Training Location</b>	<b>Sustainment Training Frequency</b>
<b>Subject Area 28. Administration/Management</b>			
<b>805C-PAD-2044</b>	Recommend Individual for Award	PLDC	QT
<b>805C-PAD-2145</b>	Counsel a Soldier on the Contents of a Noncommissioned Officer Evaluation Report and NCOER Checklist	PLDC	QT
<b>805C-PAD-2146</b>	Prepare the Rater's Portion of a Noncommissioned Officer Evaluation Report (NCOER)	PLDC	AN
<b>805C-PAD-2402</b>	Provide Input on Personnel Actions Affecting Subordinates	PLDC	QT
<b>805C-PAD-2407</b>	Recommend Disciplinary Action for a Soldier	PLDC	AN
<b>805C-PAD-2461</b>	Maintain Accountability of Personnel (Status Report)	UNIT	SA
<b>805C-PAD-2472</b>	Prepare a Duty Roster	UNIT	AN
<b>Skill Level 3</b>			
<b>Subject Area 1. Individual Conduct and Laws of War</b>			
<b>805C-PAD-3238</b>	Enforce the Equal Opportunity Program	BNCOC	QT

<b>Common Task Training Plan</b>			
<b>Task Number</b>	<b>Title</b>	<b>Training Location</b>	<b>Sustainment Training Frequency</b>
<b>Subject Area 4. Survive (Combat Techniques)</b>			
052-192-4053	Supervise Minefield Breaching Operations	UNIT	SA
071-410-0012	Conduct Occupation of an Assembly Area	BNCOC	SA
071-420-0021	Conduct a Movement to Contact by a Platoon	BNCOC	SA
071-430-0028	Consolidate a Unit	BNCOC	SA
071-430-0029	Reorganize a Unit	BNCOC	SA
<b>Subject Area 5. Navigate</b>			
071-332-5000	Prepare an Operation Overlay	BNCOC	QT
<b>Subject Area 19. Crowd Control</b>			
191-378-4302	Form Squad-Size Riot Control Formations	UNIT	AN
<b>Subject Area 21. Defense Measures</b>			
052-195-3066	Direct Construction of Nonexplosive Obstacles	UNIT	AN
071-410-0019	Control Organic Fires	UNIT	SA
441-091-3000	Supervise the Implementation of Air Defense Measures	UNIT	AN
<b>Subject Area 22. Unit Operations</b>			
071-326-3013	Conduct a Tactical Road March	BNCOC	QT

<b>Common Task Training Plan</b>			
<b>Task Number</b>	<b>Title</b>	<b>Training Location</b>	<b>Sustainment Training Frequency</b>
<b>071-326-5805</b>	Conduct a Route Reconnaissance Mission	UNIT	QT
<b>071-332-5021</b>	Prepare a Situation Map	UNIT	QT
<b>071-720-0015</b>	Conduct an Area Reconnaissance by a Platoon	UNIT	QT
<b>101-92Y-0002</b>	Plan Tactical Resupply Operations	BNCOC	SA
<b>301-371-1150</b>	Identify Intelligence and Electronic Warfare (IEW) Assets	BNCOC	AN
<b>551-88M-0001</b>	Lead a Convoy Serial/March Unit	UNIT	SA
<b>551-88N-0003</b>	Plan Unit Move	UNIT	SA
<b>Subject Area 23. Security and Control</b>			
<b>191-379-4407</b>	Plan Convoy Security Operations	UNIT	QT
<b>301-371-1052</b>	Protect Classified Information and Material	UNIT	AN
<b>805C-PAD-3594</b>	Store Classified Information and Materials	UNIT	AN

<b>Common Task Training Plan</b>			
<b>Task Number</b>	<b>Title</b>	<b>Training Location</b>	<b>Sustainment Training Frequency</b>
<b>Subject Area 24. Enemy Personnel</b>			
<b>191-379-4450</b>	Supervise Handling of Enemy Personnel and Equipment at Squad Level	UNIT	AN
<b>Subject Area 27. Risk Management</b>			
<b>850-001-3001</b>	Control Mission Safety Hazard	UNIT	QT
<b>Subject Area 28. Administration/Management</b>			
<b>805C-PAD-3147</b>	Prepare the Senior Rater's Portion of a Noncommissioned Officer Evaluation Report (NCOER)	UNIT	AN
<b>Skill Level 4</b>			
<b>Subject Area 2. First Aid</b>			
<b>081-831-1047</b>	Supervise the Implementation of Preventive Medicine Policies	UNIT	AN
<b>081-831-1055</b>	Ensure Unit Combat Lifesaver Requirements Are Met	UNIT	SA
<b>Subject Area 4. Survive (Combat Techniques)</b>			
<b>071-326-5775</b>	Coordinate with an Adjacent Platoon	ANCOC	QT
<b>101-CLT-0198</b>	Supervise Tactical Feeding Operation	UNIT	QT

<b>Common Task Training Plan</b>			
<b>Task Number</b>	<b>Title</b>	<b>Training Location</b>	<b>Sustainment Training Frequency</b>
<b>Subject Area 19. Crowd Control</b>			
<b>191-379-5400</b>	Form the Platoon into a Riot Control Formation	UNIT	SA
<b>Subject Area 21. Defense Measures</b>			
<b>071-430-0006</b>	Conduct a Defense by a Platoon	ANCOC	QT
<b>Subject Area 22. Unit Operations</b>			
<b>091-CLT-3009</b>	Supervise Maintenance Operations	ANCOC	QT
<b>101-92Y-0001</b>	Supervise Supply Activities	UNIT	QT
<b>151-357-0001</b>	Supervise CSS Functions During Platoon Operations	ANCOC	AN
<b>151-357-0002</b>	Coordinate Combat Service Support (CSS) Operations	ANCOC	AN
<b>159-200-2020</b>	Integrate Threat Capabilities into Mission Planning	ANCOC	QT
<b>181-101-4001</b>	Conduct a Search/Seizure	ANCOC	SA
<b>551-721-4326</b>	Perform Duties as Convoy Commander	UNIT	SA

<b>Common Task Training Plan</b>			
<i>Task Number</i>	<i>Title</i>	<i>Training Location</i>	<i>Sustainment Training Frequency</i>
<b>Subject Area 23. Security and Control</b>			
<b>191-379-4408</b>	Plan Security for a Command Post (CP)	UNIT	SA
<b>Subject Area 26. Crime Prevention</b>			
<b>191-379-4425</b>	Implement the Unit's Crime Prevention Program	UNIT	AN
<b>Subject Area 27. Risk Management</b>			
<b>850-001-4001</b>	Integrate Risk Management into Platoon	ANCOC	QT
<b>Subject Area 28. Administration/Management</b>			
<b>805C-PAD-4359</b>	Manage Soldier's Deployment Requirements	UNIT	SA
<b>805C-PAD-4550</b>	Prepare a Standing Operating Procedure (SOP)	ANCOC	SA
<b>805C-PAD-4597</b>	Integrate Newly Assigned Soldiers	UNIT	QT

## 2-2. SUBJECT AREA CODES.

### Skill Level 1

- 1 Individual Conduct and Laws of War
- 2 First Aid
- 3 Nuclear, Biological, and Chemical (NBC)
- 4 Survive (Combat Techniques)
- 5 Navigate
- 6 Communicate
- 7 See
- 8 Hand Grenades and Land Mines
- 9 M16-Series Rifle
- 10 M240B Machine Gun
- 11 M249 Machine Gun
- 12 M60 Machine Gun
- 13 MK19 Machine Gun
- 14 Caliber .50 M2 Machine Gun
- 15 M136 Launcher
- 16 M203 Grenade Launcher
- 17 M4 Carbine
- 18 9mm Pistol
- 19 Crowd Control
- 20 Casualty Reporting and Handling
- 21 Defense Measures

Subject Area		STP 21-1-SMCT		STP 21-24-SMCT	
		SL 1	SL 2	SL 3	SL 4
1	Individual Conduct and Laws of War	*	*	*	
2	First Aid	*	*		*
3	Nuclear, Biological, and Chemical (NBC)	*	*		
4	Survive (Combat Techniques)	*	*	*	*
5	Navigate	*	*	*	
6	Communicate	*			
7	See	*			
8	Hand Grenades and Land Mines	*			
9	M16-Series Rifle	*			
10	M240B Machine Gun	*			
11	M249 Machine Gun	*			
12	M60 Machine Gun	*			
13	MK19 Machine Gun	*			
14	Caliber .50 M2 Machine Gun	*			
15	M136 Launcher	*			
16	M203 Grenade Launcher	*			
17	M4 Carbine	*			
18	9-mm Pistol	*			
19	Crowd Control	*		*	*
20	Casualty Reporting and Handling	*	*		
21	Defense Measures	*	*	*	*
22	Unit Operations		*	*	*
23	Security and Control		*	*	*
24	Enemy Personnel			*	
25	Equipment Checks		*		
26	Crime Prevention				*
27	Risk Management		*	*	*
28	Administration/Management		*	*	*



---

Chapter 3  
**Skill Level 1 Tasks**

Skill Level 1

**SUBJECT AREA 1: INDIVIDUAL CONDUCT AND LAWS OF WAR**

---

**181-101-1013**

**Comply With the Uniform Code of Military Justice (UCMJ)**

**Conditions:** You are a soldier in the U.S. Army. You are responsible for identifying, understanding, and complying with the provisions of the U.S. Army's military justice system, including the Uniform Code of Military Justice (UCMJ). You must understand the ramifications you might face for violating the UCMJ, your commander's disciplinary options, and your legal rights in these proceedings.

**Standards:** The soldier identified, understood, and complied with the provisions of the U.S. Army's military justice system, including UCMJ. He understood the potential ramifications for violating the UCMJ, the commander's disciplinary options, and his legal rights in these proceedings.

---

**Performance Steps**

1. Define military justice.
  2. Describe the military justice system.
    - a. Describe the purpose of the military justice system.
    - b. Describe the similarities and differences between the military justice system and the American civil legal system.
    - c. Describe the UCMJ and identify to whom it applies.
  3. Identify who has authority to take disciplinary action against a soldier for misconduct.
  4. Describe a commander's responsibility to conduct a preliminary investigation into misconduct allegedly committed by a soldier under his command.
    - a. Describe the basis and procedures of a commander's inquiry.
    - b. Describe the basis and procedures of an AR 15-6 investigation.
    - c. Describe the requirement for the military police or Criminal Investigation Command (CID) to conduct a criminal investigation.
  5. List the disciplinary options available to the commander.
-

---

**Performance Steps**

---

- a. Describe how a commander can take no action at all or close a case.
  - b. Describe how a commander can use administrative or nonpunitive measures.
    - (1) List administrative or nonpunitive disciplinary measures available to a commander.
    - (2) Describe why a commander may wish to use nonpunitive or administrative disciplinary measures rather than impose nonjudicial punishment or proceed to court-martial.
  - c. Define nonjudicial punishment and how a commander can use nonjudicial punishment.
  - d. Define judicial punishment and how a commander can use judicial punishment.
  - 6. List factors a commander should consider when determining what disciplinary option to pursue.
    - a. Describe whether a commander should consider the character and military service of the accused.
    - b. Describe whether a commander should consider the nature and circumstances of the offense and the extent of the harm caused.
    - c. Describe whether a commander should consider the needs of the service and the probable effect of his decision on the command and the military community.
    - d. Describe whether a commander should consider the disposition of similar offenses in the past and the general disciplinary trends within the command.
    - e. Describe whether a commander should consider the appropriateness of the authorized punishment to the particular accused and offense.
    - f. Describe whether a commander should determine whether he has jurisdiction over the accused and the offense.
    - g. Describe whether a commander should consider the availability and admissibility of evidence against the accused.
    - h. Describe whether a commander should consider the cooperation of the accused in the apprehension or conviction of others.
    - i. Describe whether a commander should consider the possible improper motives of the accuser.
    - j. Describe whether a commander should consider that the victim or others are reluctant to testify.
-

---

**Performance Steps**

---

7. Describe nonpunitive or administrative disciplinary actions.
- a. Define an admonition or reprimand.
    - (1) Describe the purposes of an admonition or reprimand.
    - (2) Describe whether an admonition or reprimand may be in writing, orally, or both.
    - (3) Describe the soldier's legal rights in regards to an admonition or reprimand.
    - (4) Describe the commander's filing determination for a written admonition or reprimand.
    - (5) Describe whether an administrative admonition or reprimand is punitive.
  - b. Define counseling of a soldier.
    - (1) Describe the purpose for counseling.
    - (2) Describe whether counseling may be written, oral, or both.
    - (3) Describe the soldier's rights during counseling.
    - (4) Describe where a commander may file a written counseling statement.
  - c. Define withholding a soldier's privileges as an administrative disciplinary action.
    - (1) Describe the purpose for withholding privileges.
    - (2) Describe what privileges may be withheld and under what circumstances.
  - d. Define extra duty as an administrative disciplinary action.
    - (1) Describe the purpose of extra duty.
    - (2) Describe what forms or methods of extra duty may be imposed and under what circumstances.
    - (3) Describe the requirement that extra duty be tailored to address training deficiency, not used as punishment.
  - e. Define administrative separations.
    - (1) List administrative separations available under AR 635-200.
    - (2) Describe the purposes for an administrative separation action.
    - (3) Describe the procedures for an administrative separation action.
    - (4) Describe the circumstances under which a soldier is entitled to an administrative separation board.
      - (a) Describe the composition of an administrative separation board.
-

---

**Performance Steps**

---

- (b) Describe the duties and responsibilities of an administrative separation board.
  - (5) Describe a soldier's right to legal counsel for consultation and/or representation during an administrative separation action.
  - (6) Describe the types of discharges a soldier may receive from an administrative separation action.
  - (7) Identify the approval authority for an administrative separation action.
  - 8. Describe nonjudicial, or Article 15, punishment.
    - a. List who may impose nonjudicial or Article 15 punishment.
      - (1) Define who constitutes a "commander".
      - (2) Describe a superior commander's authority to withhold nonjudicial or Article 15 authority over specific offenses or persons.
      - (3) Describe the prohibition against a superior commander directing a subordinate commander to take action under Article 15 or dictating to the subordinate commander the type or quantity of punishment to be administered under Article 15.
        - b. Describe the circumstances under which a commander may wish to impose nonjudicial or Article 15 punishment.
        - c. Describe the advantages of disposing of offenses by imposing nonjudicial or Article 15 punishment.
        - d. Describe offenses for which a Commander may impose nonjudicial or Article 15 punishment.
        - e. Define a "minor" offense under the UCMJ.
        - f. Define a "summarized" Article 15 and a "formal" Article 15.
        - g. List the procedures and maximum punishment that may be imposed by a summarized Article 15.
        - h. Define a "company grade" Article 15 and a "field grade" Article 15.
        - i. Describe an accused soldier's legal rights under nonjudicial or Article 15 punishment, including the right to consultation or representation by a defense counsel.
        - j. Describe a soldier's right to turn down an Article 15 and demand trial by court-martial and the time period in which the soldier must make that decision.
        - k. Describe the procedures of a nonjudicial or Article 15 hearing.
        - l. Describe the "standard of proof" required when imposing nonjudicial or Article 15 punishment.
-

---

### Performance Steps

---

- m. Describe the maximum punishments that may be imposed by a company grade or field grade Article 15.
  - n. Describe a soldier's appellate rights subsequent to an Article 15 action.
    - (1) Describe who serves as the appellate authority.
    - (2) Describe the time period to act on an appeal.
    - (3) Describe the actions that the appellate authority may take.
  - 9. Define "preferral" of court-martial charges.
    - a. Identify who may prefer a court-martial charge.
    - b. Describe the requirement and procedures typically used to notify the accused of the charges as soon as possible after preferral.
  - 10. Define "pretrial restraint" of a soldier.
    - a. Define the purposes of pretrial restraint.
    - b. List the types of restraint.
      - (1) Define apprehension and its purpose.
        - (a) List who is authorized to apprehend persons subject to the UCMJ.
        - (b) List the factors that must be present and later articulated in order to properly apprehend a person subject to the UCMJ.
      - (2) Define conditions on liberty and its purpose.
      - (3) Define restriction, its purpose, and whether a soldier may be required to perform military duties while on restriction.
      - (4) Define arrest, its purpose, and the differences between arrest and restriction.
      - (5) Define confinement and its purpose.
        - (a) Define the factors that must exist in order to properly place a soldier in pretrial confinement.
        - (b) Identify who has the authority to place a soldier in pretrial confinement.
        - (c) Describe the review and approval procedures for pretrial confinement.
  - 11. Define "referral" of court-martial charges and identify who may refer a court-martial charge.
  - 12. Define "convening authority" for a court-martial and identify the duties and responsibilities of a convening authority.
  - 13. List the different levels of courts-martial.
-

---

**Performance Steps**

---

**a. Define a summary court-martial.**

(1) Identify who is the convening authority for a summary court-martial.

(2) Describe the types of offenses that are typically handled by a summary court-martial.

(3) Describe the types of offenses for which soldiers may be tried by a summary court-martial.

(4) Describe whether a military judge presides at a summary court-martial.

(5) Describe the presiding official at a summary court-martial.

(6) Describe whether a jury or panel exists at a summary court-martial.

(7) Describe whether an accused is entitled to be represented by defense counsel at a summary court-martial.

(8) Describe the requirement for a soldier to consent to trial by summary court-martial.

(9) Describe what happens if an accused refuses trial by summary court-martial.

(10) Describe the procedures of a summary court-martial.

(11) Describe the standard of proof for conviction at a summary court-martial.

(12) Identify who must establish or meet the standard of proof.

(13) Describe the maximum punishment that a summary court-martial may impose.

(14) Describe the appellate rights of a soldier tried and convicted by a summary court-martial.

**b. Define a special court-martial.**

(1) Identify who is the convening authority for a special court-martial.

(2) Describe what soldiers may be tried by a special court-martial.

(3) Describe whether a military judge presides at a special court-martial.

(4) Describe the duties and responsibilities of a military judge at a special court-martial.

(5) Describe whether a jury or panel exists at a special court-martial and its composition.

---

---

**Performance Steps**

---

- (a) Describe the duties and responsibilities of a jury or panel at a special court-martial.
  - (b) Describe the minimum number of jury or panel members.
  - (6) Describe whether an accused is entitled to be represented by defense counsel at a special court-martial.
  - (7) Describe the requirement for a trial counsel to represent the U.S. Government at a special court-martial.
  - (8) Describe the procedures of a special court-martial.
  - (9) Describe the Standard of Proof for conviction at a special court-martial and identify who must establish or meet this standard of proof.
  - (10) Describe the maximum punishment that a special court-martial may impose.
  - (11) Describe a soldier's appellate rights if convicted by a special court-martial.
  - (12) Describe the differences between a special court-martial and a special court-martial empowered to adjudge a bad conduct discharge.
  - c. Define a general court-martial.
    - (1) Identify who convenes a general court-martial.
    - (2) Describe what soldiers may be tried by a general court-martial.
    - (3) Describe what types of offenses are typically tried by a general court-martial.
    - (4) Describe the requirement and procedures for a pre-trial investigation, or Article 32 investigation, prior to convening a general court-martial.
    - (5) Describe whether a military judge presides at a General Court-Martial.
    - (6) Describe the duties and responsibilities of a military judge at a General Court-Martial.
    - (7) Describe whether a jury or panel exists at a general court-martial and its composition.
      - (a) Describe the duties and responsibilities of a jury or panel at a general court-martial.
      - (b) Describe the minimum number of panel or jury members.
    - (8) Describe whether an accused is entitled to be represented by defense counsel at a general court-martial.
-

---

**Performance Steps**

---

(9) Describe the requirement for a trial counsel to represent the U.S. Government at a general court-martial.

(10) Describe the procedures of a general court-martial.

(11) Describe the standard of proof required for conviction at a general court-martial and identify who must establish or meet this Standard of Proof.

(12) Describe the maximum punishment that a general court-martial may impose.

(13) Describe a soldier's appellate rights if convicted by a general court-martial.

---

**Evaluation Preparation:** Setup: Evaluate this task at the end of military justice training.

**Brief Soldier:** Tell the soldier that he will be evaluated on his ability to identify, understand, and comply with the provisions of the U.S. Army's military justice system, including the UCMJ. Tell the soldier that he will also be evaluated on his ability to understand the potential ramifications for violating the UCMJ, the commander's disciplinary options, and the soldier's legal rights in these proceedings.

Performance Measures	GO	NO GO
1. Defined military justice.	___	___
2. Described the military justice system.	___	___
a. Described the purpose of the military justice system.		
b. Described the similarities and differences between the military justice system and the American civil legal system.		
c. Described the UCMJ and to whom it applies.		
3. Identified who has authority to take disciplinary action against a soldier for misconduct.	___	___
4. Described a commander's responsibility to conduct a preliminary investigation into misconduct allegedly committed by a soldier under his command.	___	___
a. Described the basis and procedures of a commander's inquiry.		
b. Described the basis and procedures of an AR 15-6 investigation.		



<b>Performance Measures</b>	<b>GO</b>	<b>NO GO</b>
<b>c.</b> Described the requirement for the military police or Criminal Investigation Command (CID) to conduct a criminal investigation.		
<b>5.</b> Listed the disciplinary options available to the commander.	—	—
<b>a.</b> Described how a commander can take no action at all or close a case.		
<b>b.</b> Described how a commander can use administrative or nonpunitive measures.		
<b>(1)</b> Listed administrative or nonpunitive disciplinary measures available to a commander.		
<b>(2)</b> Described why a commander may wish to use nonpunitive or administrative disciplinary measures rather than impose nonjudicial punishment or proceed to court-martial.		
<b>c.</b> Defined nonjudicial punishment and how a commander can use nonjudicial punishment.		
<b>d.</b> Defined judicial punishment and how a commander can use judicial punishment.		
<b>6.</b> Listed factors a commander should consider when determining what disciplinary option to pursue.	—	—
<b>a.</b> Described whether a commander should consider the character and military service of the accused.		
<b>b.</b> Described whether a commander should consider the nature and circumstances of the offense and the extent of the harm caused.		
<b>c.</b> Described whether a commander should consider the needs of the service and the probable effect of his decision on the command and the military community.		
<b>d.</b> Described whether a commander should consider the disposition of similar offenses in the past and the general disciplinary trends within the command.		
<b>e.</b> Described whether a commander should consider the appropriateness of the authorized punishment to the particular accused and offense.		
<b>f.</b> Described whether a commander should determine whether he has jurisdiction over the accused and the offense.		

<b>Performance Measures</b>	<b>GO</b>	<b>NO GO</b>
<b>g.</b> Described whether a commander should consider the availability and admissibility of evidence against the accused.		
<b>h.</b> Described whether a commander should consider the cooperation of the accused in the apprehension or conviction of others.		
<b>i.</b> Described whether a commander should consider the possible improper motives of the accuser.		
<b>j.</b> Described whether a commander should consider that the victim or others are reluctant to testify.		
<b>7.</b> Described nonpunitive or administrative disciplinary actions.	—	—
<b>a.</b> Defined an admonition or reprimand.		
<b>(1)</b> Described the purposes of an admonition or reprimand.		
<b>(2)</b> Described whether an admonition or reprimand may be written, oral, or both.		
<b>(3)</b> Described the soldier's legal rights in regards to an admonition or reprimand.		
<b>(4)</b> Described the commander's filing determination for a written admonition or reprimand.		
<b>(5)</b> Described whether an administrative admonition or reprimand is punitive.		
<b>b.</b> Defined counseling of a soldier.		
<b>(1)</b> Described the purpose of counseling.		
<b>(2)</b> Described whether counseling may be written, oral, or both.		
<b>(3)</b> Described the soldier's rights during counseling.		
<b>(4)</b> Described where a commander may file a written counseling statement.		
<b>c.</b> Defined withholding a soldier's privileges as an administrative disciplinary action.		
<b>(1)</b> Described the purpose for withholding privileges.		
<b>(2)</b> Described what privileges may be withheld and under what circumstances.		

<b>Performance Measures</b>	<b>GO</b>	<b>NO GO</b>
<b>d.</b> Defined extra duty as an administrative disciplinary action.		
<b>(1)</b> Described the purpose of extra duty.		
<b>(2)</b> Described what forms or methods of extra duty may be imposed and under what circumstances.		
<b>(3)</b> Described the requirement that extra duty be tailored to address the training deficiency, not used as punishment.		
<b>e.</b> Defined administrative separations.		
<b>(1)</b> Listed administrative separations available under AR 635-200.		
<b>(2)</b> Described the purposes for an administrative separation action.		
<b>(3)</b> Described the procedures for an administrative separation action.		
<b>(4)</b> Described the circumstances under which a soldier is entitled to an administrative separation board.		
<b>(a)</b> Described the composition of an administrative separation board.		
<b>(b)</b> Described the duties and responsibilities of an administrative separation board.		
<b>(5)</b> Described a soldier's right to legal counsel for consultation and/or representation during an administrative separation action.		
<b>(6)</b> Described the types of discharges a soldier may receive from an administrative separation action.		
<b>(7)</b> Identified the approval authority for an administrative separation action.		
<b>8.</b> Described nonjudicial, or Article 15, punishment.	—	—
<b>a.</b> Listed who may impose nonjudicial or Article 15 punishment.		
<b>(1)</b> Defined who constitutes a "commander."		
<b>(2)</b> Described a superior commander's authority to withhold nonjudicial or Article 15 authority over specific offenses or persons.		

<b>Performance Measures</b>	<b>GO</b>	<b>NO GO</b>
<b>(3)</b> Described the prohibition against a superior commander directing a subordinate commander to take action under Article 15 or dictating to the subordinate commander the type or quantity of punishment to be administered under Article 15.		
<b>b.</b> Described the circumstances under which a commander may impose nonjudicial or Article 15 punishment.		
<b>c.</b> Described the advantages of disposing of offenses by imposing nonjudicial or Article 15 punishment.		
<b>d.</b> Described for which offenses a commander may impose nonjudicial or Article 15 punishment.		
<b>e.</b> Defined a "minor" offense under the UCMJ.		
<b>f.</b> Defined a "summarized" Article 15 and a "formal" Article 15.		
<b>g.</b> Listed the procedures and maximum punishment that may be imposed by a summarized Article 15.		
<b>h.</b> Defined a "company grade" Article 15 and a "field grade" Article 15.		
<b>i.</b> Described an accused soldier's legal rights under nonjudicial or Article 15 punishment, including the right to consultation or representation by a defense counsel.		
<b>j.</b> Described a soldier's right to turn down an Article 15 and demand trial by court-martial and the time period in which a soldier must make that decision.		
<b>k.</b> Described the procedures of a nonjudicial or Article 15 hearing.		
<b>l.</b> Described the standard of proof required when imposing nonjudicial or Article 15 punishment.		
<b>m.</b> Described the maximum punishments that may be imposed by a company grade or field grade Article 15.		
<b>n.</b> Described a soldier's appellate rights subsequent to an Article 15 hearing.		
<b>(1)</b> Described who serves as the appellate authority.		
<b>(2)</b> Described the time to act on an appeal.		

<b>Performance Measures</b>	<b>GO</b>	<b>NO GO</b>
<b>(3)</b> Described the actions that the appellate authority may take.		
<b>9.</b> Defined "preferral" of court-martial charges.	---	---
<b>a.</b> Identified who may prefer a court-martial charge.		
<b>b.</b> Described the requirement and procedures typically used to notify the accused of the charges as soon as possible after preferral.		
<b>10.</b> Defined "pretrial restraint" of a soldier.	---	---
<b>a.</b> Defined the purposes of pretrial restraint.		
<b>b.</b> Listed the types of restraint.		
<b>(1)</b> Defined apprehension and its purpose.		
<b>(a)</b> Listed who is authorized to apprehend persons subject to the UCMJ.		
<b>(b)</b> Listed the factors that must be present and later articulated in order to properly apprehend a person subject to the UCMJ.		
<b>(2)</b> Defined conditions on liberty and its purpose.		
<b>(3)</b> Defined restriction, its purpose, and whether a soldier may be required to perform military duties while on restriction.		
<b>(4)</b> Defined arrest, its purpose, and the differences between arrest and restriction.		
<b>(5)</b> Defined confinement and its purpose.		
<b>(a)</b> Defined the factors that must exist in order to properly place a soldier in pretrial confinement.		
<b>(b)</b> Identified who has the authority to place a soldier in pretrial confinement.		
<b>(c)</b> Described the review and approval procedures for pretrial confinement.		
<b>11.</b> Defined "referral" of court-martial charges and identified who may refer a court-martial charge.	---	---
<b>12.</b> Defined "convening authority" for a court-martial and identified the duties and responsibilities of a convening authority.	---	---
<b>13.</b> Listed the different levels of courts-martial.	---	---

<b>Performance Measures</b>	<b>GO</b>	<b>NO GO</b>
<b>a. Defined a summary court-martial.</b>		
<b>(1)</b> Identified the convening authority for a summary court-martial.		
<b>(2)</b> Described what types of offenses are typically handled by a summary court-martial.		
<b>(3)</b> Described what soldiers may be tried by a summary court-martial.		
<b>(4)</b> Described whether a military judge presides at a summary court-martial.		
<b>(5)</b> Described the presiding official is at a summary court-martial.		
<b>(6)</b> Described whether a jury or panel exists at a summary court-martial.		
<b>(7)</b> Described whether an accused is entitled to be represented by defense counsel at a summary court-martial.		
<b>(8)</b> Described the requirement for a soldier to consent to trial by summary court-martial.		
<b>(9)</b> Described what happens if an accused refuses trial by summary court-martial.		
<b>(10)</b> Described the procedures of a summary court-martial.		
<b>(11)</b> Described the standard of proof for conviction at a summary court-martial.		
<b>(12)</b> Identified who must establish or meet this standard of proof.		
<b>(13)</b> Described the maximum punishment that a summary court-martial may impose.		
<b>(14)</b> Described the appellate rights of a soldier tried and convicted by a summary court-martial.		
<b>b. Defined a special court-martial.</b>		
<b>(1)</b> Identified the convening authority for a special court-martial.		
<b>(2)</b> Described what soldiers may be tried by a special court-martial.		
<b>(3)</b> Described whether a military judge presides at a special court-martial.		

<b>Performance Measures</b>	<b>GO</b>	<b>NO GO</b>
<b>(4)</b> Described the duties and responsibilities of a military judge at a special court-martial.		
<b>(5)</b> Described whether a jury or panel exists at a special court-martial and its composition.		
<b>(a)</b> Described the duties and responsibilities of a jury or panel at a special court-martial.		
<b>(b)</b> Described the minimum number of jury or panel members.		
<b>(6)</b> Described whether an accused is entitled to be represented by defense counsel at a special court-martial.		
<b>(7)</b> Described the requirement for a trial counsel to represent the U.S. Government at a special court-martial.		
<b>(8)</b> Described the procedures of a special court-martial.		
<b>(9)</b> Described the standard of proof for conviction at a special court-martial and identified who must establish or meet this standard of proof.		
<b>(10)</b> Described the maximum punishment that a special court-martial may impose.		
<b>(11)</b> Described the appellate rights of a soldier's convicted by a special court-martial.		
<b>(12)</b> Described the differences between a special court-martial and a special court-martial empowered to adjudge a bad conduct discharge.		
<b>c.</b> Defined a general court-martial.		
<b>(1)</b> Identified who convenes a general court-martial.		
<b>(2)</b> Described what soldiers may be tried by a general court-martial.		
<b>(3)</b> Described what types of offenses are typically tried by a general court-martial.		
<b>(4)</b> Described the requirement and procedures for a pre-trial investigation, or Article 32 investigation, prior to convening a general court-martial.		
<b>(5)</b> Described whether a military judge presides at a general court-martial.		

Performance Measures	GO	NO GO
(6) Described the duties and responsibilities of a military judge at a general court-martial.		
(7) Described whether a jury or panel exists at a general court-martial and its composition.		
(a) Described the duties and responsibilities of a jury or panel at a general court-martial.		
(b) Described the minimum number of panel or jury members.		
(8) Described whether an accused is entitled to be represented by a defense counsel at a general court-martial.		
(9) Described the requirement for a trial counsel to represent the U.S. Government at a general court-martial.		
(10) Described the procedures of a general court-martial.		
(11) Described the standard of proof required for conviction at a general court-martial and identified who must establish or meet this standard of proof.		
(12) Described the maximum punishment that a general court-martial may impose.		
(13) Described a soldier's appellate rights if convicted by a general court-martial.		

**Evaluation Guidance:** Score the soldier GO if all performance measures are passed. Score the soldier NO GO if any performance measure is failed. If the soldier scores NO GO, show what was done wrong and how to do it correctly.

**References:**

**Required**

AR 15-6

---

## 181-105-1001

### Comply with the Law of War and the Geneva and Hague Conventions

**Conditions:** You are a soldier in the U.S. Army. You are responsible for identifying, understanding, and complying with the provisions of the Law of War, including the Geneva and Hague conventions. You are also



responsible for identifying and notifying the appropriate authorities of any suspected or known violations of the Law of War.

**Standards:** The soldier identified, understood, and complied with the Law of War. Identified problems or situations that violate the policies and took appropriate action, including notifying appropriate authorities, so expedient action could be taken to correct the problem or situation.

---

**Performance Steps**

---

1. Define the Customary Law of War.
  - a. Describe the purpose and result of the Customary Law of War.
  - b. Describe the relationship between the Customary Law of War and the Hague Convention and Geneva Convention.
2. Describe what the Hague and Geneva conventions basically represent.
3. Describe the U.S. responsibility to comply with the Hague and Geneva conventions.
4. Describe the Customary Law of War and Hague Convention's limitations on targets.
  - a. Describe the international law prohibition on targeting or attacking civilians.
  - b. Describe the Hague regulations prohibition on the destruction or seizure of enemy property unless imperatively demanded by military necessity.
  - c. Describe the Hague Regulation provisions regarding attacking a military target or a place occupied by a combatant force.
  - d. Describe the Hague Regulation prohibition against attacking an undefended town, village, dwellings, buildings, or other such place.
    - (1) Define an undefended place within the meaning of the Hague Convention.
    - (2) Describe the conditions that must exist for a place to be considered undefended.
    - (3) Describe the effect of medical units, wounded and sick, and police forces within the undefended place on the character or status of the undefended place.
  - e. Describe the permissibility of attacking or bombarding defended places.
    - (1) Define what constitutes a defended place.
    - (2) Describe the status (defended or undefended) of a city or town surrounded by detached defense positions.
  - f. Describe what constitutes a permissible military objective for attack, including bombardment.

---

**Performance Steps**

---

- g.** Describe the relationship between military necessity versus unnecessary suffering or destruction.
  - h.** Describe the protections afforded buildings dedicated to religion, art, science, or charitable purposes, or historic monuments during an attack or bombardment.
  - i.** Describe the effect on protected status afforded buildings dedicated to religion, art, science, or charitable purposes, or historic monuments if these buildings are being used for military purposes.
  - j.** Describe the protections afforded hospitals and other places where the sick and wounded are collected during an attack or bombardment.
    - (1)** Describe the effect on this protected status if enemy soldiers are the sick and wounded inside these hospitals or medical areas.
    - (2)** Describe the effect on this protected status if these hospitals or medical areas are being used for military purposes.
  - k.** Describe what may constitute an illegal trick or method or treacherous act under the Law of War in regards to permissible targets.
  - l.** Describe why illegal tricks or methods or treacherous acts are prohibited.
  - m.** Describe the legality of incidental damage to surrounding buildings during an attack on a legitimate target.
  - 5.** Describe the Customary Law of War and Hague Regulation prohibitions on the use of certain types of weapons.
    - a.** Describe the Hague Regulation prohibitions against the employment of arms, material, or projectiles designed to cause unnecessary suffering.
    - b.** Describe the possibility of a soldier violating the law of war by using an issued weapon in an illegal manner.
    - c.** Describe the Hague Regulation prohibition on the use in war of poison or poisoned weapons against human beings.
    - d.** Describe the 1925 Geneva Protocol prohibition regarding the use of asphyxiating, poisonous, or other gases, and the bacteriological methods of warfare in war.
    - e.** Describe the 1925 Geneva Protocol ban on the use of chemical weapons in war.
      - (1)** Describe the U.S. prohibition on the first use of chemical weapons in war.
-

---

**Performance Steps**

---

(2) Describe the U.S. reservation to use chemical weapons against a state if that state fails to respect the Geneva Protocol ban on the use of chemical weapons.

(3) Define a lethal agent and describe how this Geneva Protocol applies to a lethal agent.

(4) Define what constitutes an incapacitating agent and describe how this Geneva Protocol applies to an incapacitating agent.

(5) Describe the U.S. position that the Geneva Protocol does not prohibit the use of either chemical herbicides or riot control agents in war.

(a) Describe the U.S. unilateral renouncement of first use of herbicides in war and exception to this policy.

(b) Describe the U.S. policy regarding first use of riot-control agents in war.

(c) Describe the requirement for presidential approval prior to use of herbicides or riot-control agents in armed conflict.

(6) Describe the U.S. position regarding the initial or retaliatory use of bacteriological methods of warfare.

(7) Describe the 1925 Geneva Protocol position regarding the use of smoke and incendiary materials in war.

(8) Describe international law position regarding the use of nuclear weapons by air, sea, or land forces.

6. Describe the rules of the Customary Law of War and Geneva Convention of 1949 governing the humane treatment of noncombatants.

a. Define who constitutes a noncombatant.

b. Define what constitutes humane treatment.

c. Describe what acts are strictly prohibited against noncombatants.

d. Describe what constitutes humane treatment of prisoners of war.

(1) Describe how all captured persons are entitled to be treated as prisoners of war until their actual status is determined.

(2) Describe the requirement to evacuate all captured or detained persons to a detainee collection point.

(3) Describe what persons determine a captured or detained person status.

(4) Describe the Geneva Convention relative to the treatment of prisoners of war prohibition on the use of physical force, mental torture, or coercion to obtain information.

---

---

**Performance Steps**

---

(5) Describe what information the 1949 Geneva Prisoner of War Convention requires a prisoner of war to provide his captor.

(6) Describe what actions a captor or detaining power may take against a prisoner of war who refuses to answer questions, and give the practical reasons for this policy.

(7) Describe the required treatment of prisoners of war in regards to—

- (a) Daily food and living quarters.
- (b) Medical care.
- (c) Personal hygiene.
- (d) Exercise or observance of religious faith.
- (e) Retention of personal property.
- (f) Receive and send mail.
- (g) Having a prisoner representative.
- (h) Maintaining a chain of command.
- (i) Requirement to work.

(8) Describe a prisoner of war responsibility to obey lawful camp rules and disciplinary actions that may be taken against the prisoner of war for violation of these rules.

e. Describe what constitutes the humane treatment of the wounded and sick.

(1) Describe the applicability of Article 14 of the Geneva Convention for the amelioration of the condition of the wounded and sick in the armed forces in the field, and what it provides regarding the prisoner of war status of wounded and sick of a belligerent who falls into enemy hands.

(2) Describe what Article 12 of the Geneva Wounded and Sick Convention provides regarding protection and treatment of members of the armed forces who are wounded or sick.

(3) Describe the requirement to leave medical personnel and material behind to care for wounded and sick.

(4) Describe the protections afforded medical personnel.

(a) Describe how these protections apply to military medics.

(b) Describe how these protections apply to medical staff exclusively engaged in the administration of medical units and establishments.

---

---

**Performance Steps**

---

(c) Describe how these protections apply to chaplains attached to the armed forces.

(d) Describe how these protections apply to staff of national Red Cross societies and other voluntary aid organizations.

(5) Describe the status of captured full-time medical personnel as prisoners of war or retained personnel.

(a) Describe the right of retained medical personnel to perform medical duties.

(b) Describe the right and time limitation of the detaining power to retain full-time medical personnel under the Wounded and Sick Geneva Convention.

(c) Describe the requirement and procedures the detaining power must follow to return retained medical personnel to their own side.

(d) Describe the relationship of the Geneva Convention to prisoners of war and retained personnel.

(e) Describe the requirement of retained personnel to follow the captor's internal disciplinary system of the camp at which they are detained.

(6) Describe the status and protections afforded members of the armed forces specially trained for employment as hospital orderlies, nurses, or bearers of auxiliary stretchers.

(a) Describe the individual status of prisoners of war versus retained personnel.

(b) Describe the individual rights regarding return to their own side.

(c) Describe the individual rights regarding work or duties while in the prisoner of war camp.

(7) Describe the status and protections afforded members of recognized aid societies of neutral countries that lend assistance of their medical personnel and units to a party to the conflict.

(a) Describe what consent, authorization, and control mechanism are required in order for these individuals to assist a party to the conflict.

(b) Describe what notification requirements are necessary in order for these individuals to assist a party to the conflict.

(c) Describe the captor's right to detain these individuals and the requirement to return them to their own side.

---

---

**Performance Steps**

---

- (d) Describe what work these individuals may perform while detained.
  - (8) Describe the protected status of medical property, material, and equipment under the Geneva Wounded and Sick Convention.
    - (a) Describe the circumstances under which fixed medical establishments and mobile units of the medical service may be attacked.
    - (b) Describe the duty to ensure medical establishments and units are not situated near military objectives.
    - (c) Describe the relationship between protections afforded medical establishments and incidental damage, injury, or death to patients or personnel.
    - (d) Describe the possible loss of its protected status if fixed medical establishments and mobile medical units are used to commit acts harmful to the enemy.
    - (e) Describe the requirement for the enemy to warn the medical establishment prior to the loss of its protected status.
    - (f) Describe that only after the enemy provides such warning, and the warning remains unheeded, will the protection of the medical establishment lapse.
    - (g) Describe circumstances that do not deprive a medical unit or establishment of its protection.
    - (h) Describe whether medical personnel being armed and using these arms to defend themselves and the sick and wounded deprives the medical unit or establishment of its protection.
    - (i) Describe whether the medical unit or establishment being protected by a picket, sentries, or an escort in the absence of armed orderlies deprives the medical unit or establishment of its protection.
    - (j) Describe whether the establishment or medical unit is deprived of its protection if small arms or ammunition taken from the wounded and sick and not yet turned over to the proper service are found on the medical unit or establishment.
    - (k) Describe whether personnel from the medical unit or establishment providing humanitarian care to the civilian wounded or sick deprive the medical unit or establishment of its protection.
    - (l) Describe the provisions of the Geneva Wounded and Sick Convention regarding the establishment of hospital zones and localities in order to shield the wounded and sick from the impact of war.
-

---

**Performance Steps**

---

- (m)** Describe the enemy's obligation to restore medical buildings to the other side, and the ownership of captured medical material, stores, and equipment.
  - (n)** Describe a commander's authority to use medical buildings for other than medical purposes, in cases of urgent military necessity.
  - (o)** Describe the private property status and the right of requisition of real and personal property of aid societies.
  - (p)** Describe the protected status of medical aircraft.
  - (q)** Define what constitutes a medical aircraft.
  - (r)** Describe the requirement for medical aircraft to fly at heights and times, and on routes specifically agreed upon between the conflicting parties.
  - (s)** Describe the required protective markings that must be displayed on medical aircraft.
  - (t)** Describe the prohibition against medical aircraft flying over enemy territory or enemy-occupied territory.
  - (u)** Describe the requirement for medical aircraft to land, upon request from the enemy.
  - (v)** Describe the right of medical aircraft to continue their flight after examination by the enemy.
  - (w)** Describe the prisoner of war status of the wounded and sick and the aircraft crew captured by the enemy after an involuntary landing of the medical aircraft because of mechanical failure or inclement weather.
  - (x)** Describe the emblem or distinctive sign of the medical service of an armed force.
  - (y)** Describe what other medical service emblems are recognized by the Geneva Convention.
  - (z)** Describe whether the Star of David, used by the State of Israel, is specifically recognized by the Geneva Convention.
  - (aa)** Describe under what direction and where these medical service emblems must be displayed.
  - (ab)** Describe what medical service emblems medical personnel are required to wear and where these emblems should be displayed.
  - (ac)** Describe the requirement for medical personnel to carry a special identity card bearing the medical emblem.
-

---

**Performance Steps**

---

**(ad)** Describe the circumstances under which medical personnel may be deprived of their insignia, identity cards, or the right to wear the armlet.

**(ae)** Describe the right of medical personnel to receive duplicate identity cards or replace insignia if lost.

**(af)** Describe the medical service emblems that auxiliary stretcher bearers must wear and when they must wear these emblems.

**(ag)** Describe what information must be specified on the military identity documents of auxiliary stretcher bearers.

**(ah)** Describe what flag may be flown over medical units and establishments.

**(ai)** Describe what flags may be flown over captured medical units.

**(aj)** Describe the requirement for distinctive emblems indicating medical units and establishments to be clearly visible to the enemy land, air, or naval forces.

**(ak)** Describe what flags may be flown over medical units belonging to aid societies of neutral countries assisting a party to the conflict.

**f.** Describe what constitutes the humane treatment of civilians.

**(1)** Describe what rights and protections are afforded the civilian population of the country in conflict under Article 27 of the Geneva Convention relative to the protection of civilian persons in time of war.

**(2)** Describe the rights of civilians to be protected against all acts or threats of violence and against insults and public curiosity.

**(3)** Describe the rights of civilian women to be protected against attack, enforced prostitution, rape, and other forms of sexual assault.

**(4)** Describe the right of an occupying force to enforce control and security measures and how commanders must ensure that all persons are treated humanely, while enforcing control and security measures.

**(5)** Describe the right of civilians not to be subjected to medical or scientific experiments, nor made the object of collective penalties or reprisals, or held hostage.

**(6)** Describe the right of civilians to have their property protected from pillage or looting.

**(7)** Describe the right of the occupying power to establish laws and try and punish civilians for violations of these occupation laws.

**7.** Describe the responsibilities of U.S. soldiers to obey the Law of War.

---



---

**Performance Steps**

---

- a. Describe how U.S. soldiers are bound to obey all the rules of the Customary Law of War and the Hague and Geneva conventions.
- b. Describe how U.S. soldiers may be court-martialled for violating these rules.
- c. Describe how U.S. soldiers may also be prosecuted for committing a war crime.
- d. Define a grave breach of the Law of War.
  - (1) Describe what criminal offenses may constitute a grave breach.
  - (2) Describe what disciplinary actions may be taken against a U.S. soldier, who commits a grave breach.
  - (3) Describe the statute of limitations on the prosecution of a war crime.
  - (4) Describe the responsibilities of the United States, as a signatory of the Geneva Convention, regarding a person who commits a grave breach.
- e. Describe the responsibilities of the commander in regards to violations of the Law of War.
  - (1) Describe how the legal responsibility for the commission of a war crime can be placed on the commander as well as the subordinate who actually commits the war crime.
  - (2) Describe the circumstances under which a commander may be prosecuted for the commission of a war crime.
- f. Describe a criminal order and a soldier's responsibility toward a criminal order.
  - (1) Describe the applicability of a soldier asserting the defense of "obeying a superior order" for the commission of a war crime.
  - (2) Describe whether a subordinate soldier, who actually commits a war crime, is excused from prosecution if the commander is charged with the commission of the war crime.
  - (3) Describe the responsibility of a soldier to disobey any order that requires the soldier to commit criminal acts in violation of the Law of War.
  - (4) Describe the responsibility of a soldier to obey the rules of engagement and the potential consequences for violating the rules of engagement.
  - (5) Describe the responsibility of the soldier to ask a superior for clarification of an order presumed to be criminal or illegal.
- g. Describe a soldier's obligation to report violations of the Law of War.

---

**Performance Steps**

---

(1) Describe the requirement of a soldier to inform the chain of command of known or suspected violations of the Law of War.

(2) Describe what other avenues or agencies are available for the soldier to report known or suspected violations of the Law of War.

(3) Describe when soldiers should notify their chain of command or alternative agencies of known or suspected violations of the Law of War.

---

**Evaluation Preparation:**

*Setup:* Evaluate this task at the end of Law of War training.

*Brief Soldier:* Tell the soldier that he will be evaluated on his ability to identify, understand, and comply with the Law of War, including the Geneva and Hague conventions. Tell the soldier that he will also be evaluated on his ability to identify problems or situations that violate the Law of War and take appropriate action, including notifying appropriate authorities of suspected or actual violations of the Law of War, so expedient action may be taken to correct the problem or situation.

Performance Measures	GO	NO GO
1. Defined the Customary Law of War.	_____	_____
a. Described the purpose and result of the Customary Law of War.		
b. Described the relationship between the Customary Law of War and the Hague Convention of 1907 and the Geneva Convention of 1949.		
2. Described what the Hague and Geneva conventions basically represent.	_____	_____
3. Described the U.S. responsibility to comply with the Hague and Geneva conventions.	_____	_____
4. Described the Customary Law of War and Hague Convention limitation on targets.	_____	_____
a. Described the international law prohibition on targeting or attacking civilians.		
b. Described the Hague Regulation prohibition on the destruction or seizure of enemy property unless imperatively demanded by military necessity.		
c. Described the Hague Regulation provisions regarding attacking a military target or a place occupied by a combatant force.		

<b>Performance Measures</b>	<b>GO</b>	<b>NO GO</b>
<b>d.</b> Described the Hague Regulation prohibition against attacking an undefended town, village, dwellings, buildings, or other such place.		
<b>(1)</b> Defined an undefended place within the meaning of the Hague Convention.		
<b>(2)</b> Described the condition that must exist for a place to be considered undefended.		
<b>(3)</b> Described the effect of medical units, wounded and sick, and police forces within the undefended place on the character or status of the undefended place.		
<b>e.</b> Described the permissibility of attacking or bombarding defended places.		
<b>(1)</b> Defined what constitutes a defended place.		
<b>(2)</b> Described the status (defended or undefended) of a city or town surrounded by detached defense positions.		
<b>f.</b> Described what constitutes a permissible military objective for attack, including bombardment.		
<b>g.</b> Described the relationship between military necessity versus unnecessary suffering or destruction.		
<b>h.</b> Described the protections afforded buildings dedicated to religion, art, science, or charitable purposes, or historic monuments during an attack or bombardment.		
<b>i.</b> Described the effect on protected status afforded buildings dedicated to religion, art, science, or charitable purposes, or historic monuments if these buildings are being used for military purposes.		
<b>j.</b> Described the protections afforded hospitals and other places where the sick and wounded are collected during an attack or bombardment.		
<b>(1)</b> Described the effect on this protected status if enemy soldiers are the sick or wounded inside these hospitals or medical areas.		
<b>(2)</b> Described the effect on this protected status if these hospitals or medical areas are being used for military purposes.		

Performance Measures	GO	NO GO
<b>k.</b> Described what may constitute an illegal trick or method or treacherous act under the Law of War in regards to permissible targets.		
<b>l.</b> Described why illegal tricks or methods or treacherous acts are prohibited.		
<b>m.</b> Described the legality of incidental damage to surrounding buildings during an attack on a legitimate target.		
<b>5.</b> Described the Customary Law of War and Hague Regulation prohibitions on the use of certain types of weapons.	—	—
<b>a.</b> Described the Hague Regulation prohibitions against the employment of arms, material, or projectiles designated to cause unnecessary suffering.		
<b>b.</b> Described the possibility of a soldier violating the Law of War by using an issued weapon in an illegal manner.		
<b>c.</b> Described the Hague Regulation prohibitions on the use, in war, of poison or poisoned weapons against human beings.		
<b>d.</b> Described the 1925 Geneva Protocol prohibition regarding the use, in war, of asphyxiating, poisonous, or other gases, and bacteriological methods of warfare.		
<b>e.</b> Described the 1925 Geneva Protocol ban on the use of chemical weapons in war.		
<b>(1)</b> Described the U.S. prohibition on the first use of chemical weapons in war.		
<b>(2)</b> Described the U.S. reservation to use chemical weapons against a state if that state fails to respect the Geneva Protocol ban on the use of chemical weapons.		
<b>(3)</b> Defined a lethal chemical agent and described how this Geneva Protocol applies to a lethal chemical agent.		
<b>(4)</b> Defined what constitutes an incapacitating chemical agent and described how this Geneva Protocol applies to an incapacitating chemical agent.		

<b>Performance Measures</b>	<b>GO</b>	<b>NO GO</b>
<b>(5)</b> Described the U.S. position that the Geneva Protocol does not prohibit the use of either chemical herbicides or riot-control agents in war.		
<b>(a)</b> Described the U.S. unilateral renouncement of first use of herbicides in war and exception to this policy.		
<b>(b)</b> Described the U.S. policy regarding first use of riot-control agents in war.		
<b>(c)</b> Described the requirement for Presidential approval prior to use of herbicides or riot-control agents in armed conflict.		
<b>(6)</b> Described the U.S. position regarding the initial or retaliatory use of bacteriological methods of warfare.		
<b>(7)</b> Described the 1925 Geneva Protocol position regarding the use of smoke and incendiary materials in war.		
<b>(8)</b> Described international law position regarding the use of nuclear weapons by air, sea, or land forces.		
<b>6.</b> Described the rules of the Customary Law of War and Geneva Convention of 1949 governing the humane treatment of noncombatants.	—	—
<b>a.</b> Defined who constitutes a noncombatant.		
<b>b.</b> Defined what constitutes humane treatment.		
<b>c.</b> Described what acts are strictly prohibited against noncombatants.		
<b>d.</b> Described what constitutes humane treatment of prisoners of war.		
<b>(1)</b> Described how all captured persons are entitled to be treated as prisoners of war until their actual status is determined.		
<b>(2)</b> Described the requirement to evacuate all captured or detained persons to a detainee collection point.		
<b>(3)</b> Described what persons determine a captured or detained person's status.		

<b>Performance Measures</b>	<b>GO</b>	<b>NO GO</b>
<b>(4)</b> Described the Geneva convention relative to the treatment of prisoners of war prohibition on the use of physical force, mental torture, or coercion to obtain information.		
<b>(5)</b> Described what information the 1949 Geneva Prisoner of War Convention requires a prisoner of war to provide to his captor.		
<b>(6)</b> Described what actions a captor or detaining power may take against a prisoner of war who refuses to answer questions, and the practical reasons for this policy.		
<b>(7)</b> Described the required treatment of prisoners of war in regards to—		
<b>(a)</b> Daily food and living quarters.		
<b>(b)</b> Medical care.		
<b>(c)</b> Personal hygiene.		
<b>(d)</b> Exercise or observance of religious faith.		
<b>(e)</b> Retention of personal property.		
<b>(f)</b> Receive and send mail.		
<b>(g)</b> Having a prisoner's representative.		
<b>(h)</b> Maintaining a chain of command.		
<b>(i)</b> Requirement to work.		
<b>(8)</b> Described a prisoner of war responsibility to obey lawful camp rules and disciplinary actions that may be taken against the prisoner of war for violation of these rules.		
<b>e.</b> Described what constitutes the humane treatment of the wounded and sick.		
<b>(1)</b> Described the applicability of Article 14 of the Geneva Convention for the amelioration of the condition of the wounded and sick in the armed forces in the field and what it provides regarding the prisoner of war status of wounded and sick of a belligerent who falls into enemy hands.		
<b>(2)</b> Described what Article 12 of the Geneva Wounded and Sick Convention provides regarding protection and treatment of members of the armed forces who are wounded or sick.		

<b>Performance Measures</b>	<b>GO</b>	<b>NO GO</b>
<b>(3)</b> Described the requirement to leave medical personnel and material behind to care for wounded and sick.		
<b>(4)</b> Described the protections afforded medical personnel.		
<b>(a)</b> Described how these protections apply to military medics.		
<b>(b)</b> Described how these protections apply to medical staff exclusively engaged in the administration of medical units and establishments.		
<b>(c)</b> Described how these protections apply to chaplains attached to the armed forces.		
<b>(d)</b> Described how these protections apply to staff of national Red Cross societies and other voluntary aid organizations.		
<b>(5)</b> Described the status of captured full-time medical personnel as prisoners of war or retained personnel.		
<b>(a)</b> Described the right of retained medical personnel to perform medical duties.		
<b>(b)</b> Described the right and time limitation of the detaining power to retain full-time medical personnel under the wounded and sick Geneva Convention.		
<b>(c)</b> Described the requirement and procedures the detaining power must follow to return retained medical personnel to their own side.		
<b>(d)</b> Described the relationship of the Geneva Convention relative to prisoners of war and retained personnel.		
<b>(e)</b> Described the requirement of retained personnel to follow the captors' internal disciplinary system at the camp where they are detained.		
<b>(6)</b> Described the status and protection afforded members of the armed forces specially trained for employment as hospital orderlies, nurses, or auxiliary stretcher bearers.		
<b>(a)</b> Described these individuals' status as prisoners of war versus retained personnel.		

Performance Measures	GO	NO GO
(b) Described these individuals' rights regarding return to their own side.		
(c) Described these individuals' rights regarding work or duties while in the prisoner of war camp.		
(7) Described the status and protections afforded members of recognized aid societies of neutral countries that lend assistance of their medical personnel and units to a party to the conflict.		
(a) Describe what consent, authorization, and control mechanisms are required in order for these individuals to assist a party to the conflict.		
(b) Described what notification requirements are necessary in order for these individuals to assist a party to the conflict.		
(c) Described the captor's right to detain these individuals and the requirement to return them to their own side.		
(d) Described what work these individuals may perform while detained.		
(8) Described the protected status of medical property, material, and equipment under the Geneva Wounded and Sick Convention.		
(a) Described the circumstances under which fixed medical establishments and mobile units of the medical service may be attacked.		
(b) Described the duty to ensure medical establishments and units are not situated near military objectives.		
(c) Described the relationship between protections afforded medical establishments and incidental damage, injury, or death to patients or personnel.		
(d) Described the possible loss of its protected status if fixed medical establishments and mobile units are used to commit acts harmful to the enemy.		



<b>Performance Measures</b>	<b>GO</b>	<b>NO GO</b>
<b>(e)</b> Described the requirement for the enemy to warn the medical establishment prior to the loss of its protected status.		
<b>(f)</b> Described that only after the enemy provides such warning, and the warning remains unheeded, will protection of the medical establishment lapse.		
<b>(g)</b> Described circumstances that do not deprive a medical unit or establishment of its protection.		
<b>(h)</b> Described whether medical personnel being armed and using those arms to defend themselves and the sick and wounded deprive the medical unit or establishment of its protection.		
<b>(i)</b> Described whether the medical unit or establishment being protected by a picket, sentries, or an escort in the absence of armed orderlies deprives the medical unit or establishment of its protection.		
<b>(j)</b> Described whether the discovery of small arms and ammunition taken from the wounded and sick and not yet turned over to the proper service on the medical unit or establishment deprives the medical unit or establishment of its protection.		
<b>(k)</b> Described whether personnel from the medical unit or establishment providing humanitarian care to the civilian wounded or sick deprive the medical unit or establishment of its protection.		
<b>(l)</b> Described the provisions of the Geneva Wounded and Sick Convention regarding the establishment of hospital zones and localities in order to shield the wounded and sick from the impact of war.		
<b>(m)</b> Described the enemy's obligation to restore medical buildings to the other side and the ownership of captured medical material, stores, and equipment.		
<b>(n)</b> Described the authority of a commander to use medical buildings for other than medical purposes, in cases of urgent military necessity.		
<b>(o)</b> Described the private property status and the right of requisition of real and personal property of aid societies.		

Performance Measures	GO	NO GO
(p) Described the protected status of medical aircraft.		
(q) Defined what constitutes a medical aircraft.		
(r) Described the requirement for medical aircraft to fly at heights, times, and on routes specifically agreed upon between the conflicting parties.		
(s) Described the required protective markings that must be displayed on medical aircraft.		
(t) Described the prohibition against medical aircraft flying over enemy territory or enemy-occupied territory.		
(u) Described the requirement for medical aircraft to land, upon request from the enemy.		
(v) Described the right of medical aircraft to continue their flight after examination from the enemy.		
(w) Described the prisoner of war status of the wounded and sick and the aircraft crew captured by the enemy after an involuntary landing of the medical aircraft because of mechanical failure or inclement weather.		
(x) Described the emblem or distinctive sign of the medical service of an armed force.		
(y) Described what other medical service emblems are recognized by the Geneva Convention.		
(z) Described whether the Star of David, used by the State of Israel, is specifically recognized by the Geneva Convention.		
(aa) Described under what direction and where these medical service emblems must be displayed.		
(ab) Described what medical service emblems medical personnel are required to wear and where these emblems should be displayed.		
(ac) Described the requirement for medical personnel to carry a special identity card bearing the medical emblem.		

Performance Measures	GO	NO GO
(ad) Described the circumstances under which medical personnel may be deprived of their insignia, identity cards, or the right to wear the armband.		
(ae) Described the right of medical personnel to receive duplicate identity cards or replace insignia if lost.		
(af) Described the medical service emblems that auxiliary stretcher bearers must wear and when they must wear these emblems.		
(ag) Described what information must be specified on the military identity documents of auxiliary stretcher bearers.		
(ah) Described what flag may be flown over medical units and establishments.		
(ai) Described what flags may be flown over captured medical units.		
(aj) Described the requirement for distinctive emblems indicating medical units and establishments to be clearly visible to the enemy land, air, or naval forces.		
(ak) Described what flags may be flown over medical units belonging to aid societies of neutral countries assisting a party to the conflict.		
f. Described what constitutes the humane treatment of civilians.		
(1) Described what rights and protections are afforded the civilian population of the country in conflict under Article 27 of the Geneva Convention relative to the protection of civilian persons in time of war.		
(2) Described the rights of civilians to be protected against all acts or threats of violence and against insults and public curiosity.		
(3) Described the rights of civilian women to be protected against attack, enforced prostitution, rape, and other forms of sexual assault.		
(4) Described the right of an occupying force to enforce control and security measures and how commanders must ensure that all persons are treated humanely while enforcing control and security measures.		

Performance Measures	GO	NO GO
(5) Described the right of civilians not to be subjected to medical or scientific experiments, nor made the object of collective penalties or reprisals, or held hostage.		
(6) Described the right of civilians to have their property protected from pillage or looting.		
(7) Described the right of the occupying power to establish laws and try and punish civilians for violation of these occupation laws.		
7. Described the responsibility of U.S. soldiers to obey the Law of War.	—	—
a. Described how U.S. soldiers are bound to obey all the rules of the Customary Law of War and the Hague and Geneva conventions.		
b. Described how U.S. soldiers may be court-martialed for violating these rules.		
c. Described how U.S. soldiers may also be prosecuted for committing a war crime.		
d. Defined a grave breach of the Law of War.		
(1) Described what criminal offenses may constitute a grave breach.		
(2) Described what disciplinary actions may be taken against U.S. soldiers who commit a grave breach.		
(3) Described the statute of limitations on the prosecution of a war crime.		
(4) Described the responsibilities of the United States, as a signatory of the Geneva Conventions, regarding a person who commits a grave breach.		
e. Described the responsibility of the commander in regards to violations of the Law of War.		
(1) Described how the legal responsibility for the commission of a war crime can be placed on the commander as well as the subordinate who actually commits the war crime.		
(2) Described the circumstances under which a commander may be prosecuted for the commission of a war crime.		

Performance Measures	GO	NO GO
<b>f.</b> Described a criminal order and a soldier's responsibility toward a criminal order.		
<b>(1)</b> Described the applicability of a soldier asserting the defense of "obeying a superior order" for the commission of a war crime.		
<b>(2)</b> Described whether a subordinate soldier, who actually commits a war crime, is excused from prosecution if the commander is charged with the commission of the war crime.		
<b>(3)</b> Described the responsibility of a soldier to disobey any order that requires the soldier to commit criminal acts in violation of the Law of War.		
<b>(4)</b> Described the responsibility of a soldier to obey the rules of engagement and the potential consequences for violating the rules of engagement.		
<b>(5)</b> Described the responsibility of the soldier to ask a superior for clarification of an order presumed to be criminal or illegal.		
<b>g.</b> Described a soldier's obligation to report violations of the Law of War.		
<b>(1)</b> Described the requirement of a soldier to inform the chain of command of known or suspected violations of the Law of War.		
<b>(2)</b> Described what other avenues or agencies are available for the soldier to report known or suspected violations of the Law of War.		
<b>(3)</b> Described when soldiers should notify their chain of command or alternative agencies of known or suspected violations of the Law of War.		

**Evaluation Guidance:** Score the soldier GO if all performance measures are passed. Score the soldier NO GO if any performance measure is failed. If the soldier scores NO GO, show the soldier what was done wrong and how to do it correctly.

**References**

**Required**

**Related**

FM 27-10

---

## 224-176-1425

### Interact with News Media

**Conditions:** In a field, military operations in urban terrain (MOUT) or garrison environment interact with news media when no public affairs practitioners are present.

**Standards:** Identified the principles of interacting with the media.

---

#### Performance Steps

---

1. Role of the individual when interacting with the media.
    - a. Check identification or press credentials. If identification or press credentials are produced, continue with interview. If no identification or press credentials are produced, refer the individual to your chain of command or public affairs representative.
    - b. Recognize your rights.
      - (1) You don't have to speak to the media.
      - (2) You don't have to answer all the questions.
      - (3) You control the length of the interview.
    - c. Maintain operational security (OPSEC). Do not discuss classified information.
  2. Guidelines for speaking with the media.
    - a. Think before you answer.
    - b. Tell the truth. You should not lie or intentionally mislead members of the media.
    - c. Discuss only things that you have direct responsibility for or have personal knowledge about. Speak at your level. You should discuss only matters for which you have direct knowledge.
    - d. Don't answer speculative (what if) or hypothetical questions.
    - e. Avoid jargon, acronyms, slang and technical terms.
    - f. Answer the question with which you are most comfortable when asked multiple questions.
    - g. Keep remarks brief and concise.
    - h. Assume everything you say may be printed or broadcast.
    - i. Use "I" not "we" when stating your opinion.
    - j. If you don't know the answer to a question or cannot discuss it for any reason, say so. Avoid using "no comment".
  3. Inform the chain of command of interaction with the media.
- 

#### Evaluation Preparation:

*Setup:* Provide soldier with a realistic scenario of a simulated media interview situation. Use mock press credentials when necessary.

*Brief Soldier:* Tell the soldier he is about to be interviewed by the media. No public affairs representatives are present. Evaluate soldier on his ability to interact with the media.

Performance Measures	GO	NO GO
1. Checked media representative for identification or credentials.	___	___
2. Stated three recognized rights.	___	___
3. Maintained OPSEC throughout the interview.	___	___
4. Discussed subject areas related to direct responsibility and personal knowledge.	___	___
5. Stated answers while avoiding speculation.	___	___
6. Performed interview without use of jargon, acronyms, slang or technical terms.	___	___
7. Employed concise remarks.	___	___
8. Ensured no "off-the-record" comments were made.	___	___
9. Stated answers, avoiding "no comment" response.	___	___
10. Informed chain of command of interaction with media.	___	___

**Evaluation Guidance:** Score the soldier GO if 70 percent or more of the performance measures are passed. Score the soldier NO GO if less than 70 percent of the measures are passed. If the soldier scores NO GO on any performance measure, show or tell him what was wrong and how to perform the measure correctly.

**References**

**Required**

AR 360-1

FM 46-1

**Related**

---

**331-202-1049**

**Comply with the Requirements of the Code of Conduct**

**Conditions:** Given a Survival, Evasion, Resistance or Escape (SERE) situation or a captivity environment.

**Standards:** Acted in accordance with the standards represented in Articles I through VI of the Code of Conduct.

---

**Performance Steps**

---

**1.** Comply with Article I: I am an American, fighting in the forces which guard my country and our way of life. I am prepared to give my life in their defense.

Explanation. The code applies to all service members at all times, whether in active combat, in captivity, or in peacetime as a result of hostage situations and terrorist activities. Members of the Armed Forces have a duty to support U.S. interests and oppose U.S. enemies regardless of the circumstances.

**2.** Comply with Article II: I will never surrender of my own free will. If in command, I will never surrender the members of my command while they still have the means to resist.

Explanation. Members of the Armed Forces may never surrender voluntarily. A soldier's duty is to avoid capture and return to friendly forces even when isolated, and no longer able to inflict casualties on the enemy or otherwise defend themselves. The means to evade is considered exhausted when escape is impossible. The means to resist is considered exhausted when further fighting would lead to the soldier's death with no significant loss to the enemy.

**3.** Comply with Article III: If I am captured, I will continue to resist by all means available. I will make every effort to escape and aid others to escape. I will accept neither parole nor special favors from the enemy.

Explanation. Members of the Armed Forces must understand that a captive situation is to be considered an extension of the battlefield and the enemy has used a variety of tactics to exploit prisoners of war in disregard of the Geneva Convention of 1949 Relative to the Treatment of Prisoners of War. These efforts have included physical and mental harassment, general mistreatment and torture, medical neglect, and political indoctrination. The duty of a member of the Armed Forces to continue resistance to enemy exploitation by all means available is not lessened by the misfortune of capture.

---



---

**Performance Steps**

---

**4.** Comply with Article IV: If I become a prisoner of war, I will keep faith with my fellow prisoners. I will give no information or take part in any action which might be harmful to my comrades. If I am senior, I will take command. If not, I will obey the lawful orders of those appointed over me and will back them up in every way.

Explanation. Officers and noncommissioned officers will continue to carry out their responsibilities and to exercise their authority in captivity. Informing on fellow prisoners of war (PWs) is forbidden. PWs must especially avoid helping the enemy to identify fellow PWs who have information that is of value to the enemy. These PWs may be made to suffer coercive interrogation because of their knowledge.

**5.** Comply with Article V: When questioned, should I become a prisoner of war, I am required to give name, rank, service number, and date of birth. I will evade answering further questions to the utmost of my ability. I will make no oral or written statements disloyal to my country and its allies or harmful to their cause.

Explanation. When questioned a PW is required by the Geneva Conventions and the Code of Conduct, E.O. 10631 and is permitted by the UCMJ to give name, rank, service number and date of birth. Under the Geneva Conventions the enemy has no right to try to force a PW to provide any additional information. However, it is unrealistic to expect a PW to remain confined for years reciting only name, rank, service number and date of birth. There are many PW camp situations in which certain types of conversation with the enemy are permitted. For example, a PW is allowed, but not required by the Code of Conduct, the UCMJ or the Geneva Conventions to fill out a Geneva Conventions "capture card," to write letters home, and to communicate with captors on matters of health and welfare.

**6.** Comply with Article VI: I will never forget that I am an American, fighting for freedom, responsible for my actions, and dedicated to the principles which made my country free. I will trust in my God and in the United States of America.

Explanation. A member of the Armed Forces remains responsible for personal actions at all times. Article VI is designed to assist members of the Armed Forces to fulfill their responsibilities and survive captivity with honor. The Code of Conduct, E.O. 10631, does not conflict with the UCMJ, and the latter continues to apply to each military member during captivity or other hostile detention. Soldiers, whether detainees or captives, can be assured the U.S. Government will make every effort to obtain their earliest release. Faith in one's country and its way of life, faith in fellow detainees or captives, and faith in one's self are critical to surviving with honor and resisting exploitation.

---

**Evaluation Preparation:** Setup: Develop an exercise scenario based on wartime mission requirements (including geographical areas of deployment). The scenario should reflect enemy doctrine, capabilities, vulnerabilities, political and cultural aspects and PW management procedures. Develop a control plan, which incorporates the risk assessment and instructions for controlling and evaluating the player unit. Develop and design the intelligence information to be coordinated, synchronized and released to bring the play on the intended path. Test the soldier on his ability to apply elements of the Code of Conduct in a SERE situation or a captivity environment during the survival/evasion portion of the local Major Army Command battalion, company, or platoon field training exercise (FTX). Maximum combat realism should be applied to tactical exercises consistent with good safety practices. The use of PW compounds and resistance training laboratories by other than USAJFKSWCS to teach Code of Conduct and SERE training is prohibited in accordance with AR 350-30.

**Brief Soldier:** Tell the soldier the Code of Conduct provides him with a set of guiding principles, moral obligations and professional ethics to survive and return home with honor from a SERE environment and is not to be interpreted as a set of inflexible laws. Tell the soldier he is required to comply with the guidelines in the Code of Conduct and in FM 3-05.71, Resistance and Escape, chapters 2 and 13.

Performance Measures	GO	NO GO
1. Complied with Article I of the Code of Conduct.	___	___
2. Complied with Article II of the Code of Conduct.	___	___
3. Complied with Article III of the Code of Conduct.	___	___
4. Complied with Article IV of the Code of Conduct.	___	___
5. Complied with Article V of the Code of Conduct.	___	___
6. Complied with Article VI of the Code of Conduct.	___	___

**Evaluation Guidance:** Conduct an exercise after action review to allow training participants to discover what happened, why it happened and how it can be done better. Once all key points have been discussed and linked to future training, the evaluator will make the appropriate notes for inclusion into the score. Score the soldier GO if all performance measures are passed. Score the soldier NO GO if any performance measure is failed. If the soldier fails, show what was done wrong and how to do it correctly.

---

## References

### Required

AR 350-30  
AR 350-41  
DODD 1300.7  
FM 3-05.71

### Related

---

## 805C-PAD-1245

### Support Unit and Family Readiness Through the Army Family Team Building (AFTB) Program

**Conditions:** You are a soldier in the U. S. Army. You have access to AR 27-3, AR 600-20; AR 608-1, AR 608-18; AR 608-99, DA Pam 360-525; DA Pam 608-47; DA Cir 608-95, DA Form 5304-R, *Family Care Counseling Checklist*; DA Form 5305-R, *Family Care Plan*; and DD Form 93, *Record of Emergency Data*. As an individual or member of a unit, you may deploy on short notice for an indefinite time to support Army missions worldwide.

**Standards:** Your family was prepared for your separation during deployments and aware of unit and installation programs that could provide assistance.

---

### Performance Steps

1. Prepare your family to take care of day-to-day business and challenges they may face during your separation.
    - a. Take positive and proactive steps to prepare your family for your possible separation.
      - (1) Enroll your spouse in the local installation Army Family Team Building Course.
      - (2) Develop a family readiness checklist.
    - b. Ensure your spouse or designated guardian understands and has access to current personal records.
      - (1) Maintain a current DA Form 5304-R.
      - (2) Maintain a current DD Form 93.
      - (3) Ensure your spouse or designated guardian has access to a valid special power of attorney.
      - (4) Ensure your spouse or designated guardian has access to a valid general power of attorney.
      - (5) Ensure your spouse or designated guardian has access to current family member ID cards and ID tags.
-

---

**Performance Steps**

---

(6) Ensure your spouse or designated guardian has access to valid passports (when appropriate).

(7) Ensure your spouse or designated guardian has access to copies of all social security cards and records.

(8) Ensure your spouse or designated guardian has access to a copy of other records, documents and papers (household goods or property inventory papers).

(9) Complete all pending administrative actions.

(10) Ensure your spouse or designated guardian is well versed on all of your personal affairs.

c. Ensure your spouse or designated guardian has access to medical and dental records and understands medical requirements.

(1) Ensure your family members are enrolled in TRICARE and that your spouse or designated guardian understands how to access medical care.

(2) Ensure your family members are enrolled in the Army's dental plan and that your spouse or designated guardian understands how to access dental care.

(3) Ensure your spouse or designated guardian has access to current family member immunization records.

(4) Ensure family members with special needs are enrolled in the Exceptional Family Members Program (EFMP).

(5) Ensure your spouse or designated guardian is well versed on all medical requirements.

d. Ensure your spouse or designated guardian has access to and understands current legal affairs and business plans.

(1) Ensure your spouse or designated guardian has access to and understands family member birth certificates.

(2) Ensure your spouse or designated guardian has access to your current marriage certificate.

(3) Ensure your spouse or designated guardian has access to any divorce papers.

(4) Ensure your spouse or designated guardian has access to current life insurance policies and medical policies.

(5) Ensure your spouse or designated guardian has access to current and valid real estate documents: deeds, titles, mortgages, tax receipts, insurance policies, and leases.

---

---

**Performance Steps**

---

(6) Ensure your spouse or designated guardian has access to automobile titles, registrations, insurance policies, liens, and payment books.

(7) Ensure your spouse or legal guardian has a valid driver's license or arrangements have been made for transportation of a spouse who does not drive or own an automobile.

(8) Ensure your spouse, designated guardian, business associates, or partners are aware of your role in the military and the possibility of being mobilized.

(9) Consult with your private attorney regarding how your business affairs should be handled during your absence.

(10) Ensure your spouse or designated guardian is well versed on all of your legal and business affairs.

e. Ensure your spouse or designated guardian has access to and understands current financial affairs.

(1) Ensure your spouse or designated guardian understands the Army pay system and can read and understand your leave and earning statement (LES).

(2) Ensure your spouse or designated guardian understands your benefits, entitlements, and compensations.

(3) Ensure your spouse or designated guardian is well versed on survivor benefits and assistance.

(4) Ensure your spouse has proper authorization to write checks and access your bank account(s).

(5) Ensure any allotments to provide support to family members have been initiated and are adequate to provide support.

(6) Ensure your spouse or designated guardian has access to all federal and state income tax, real estate, and personal property tax records.

(7) Inform your spouse or designated guardian of any stocks, bonds, and mutual funds.

(8) Inform your spouse or designated guardian of any outstanding legal debts or contracts such as credit cards, installment contracts, mortgages, leases, and bills of sale.

2. Ensure your spouse is aware of unit and installation programs that can provide assistance during separation.

a. Ensure your spouse or designated guardian is knowledgeable of all the unit programs available to provide assistance in your absence.

---

---

**Performance Steps**

---

- (1)** Attend, with your spouse or designated guardian when possible, unit pre-deployment briefings.
  - (2)** Ensure your spouse or designated guardian is knowledgeable of the unit rear detachment command.
    - (a)** Ensure your spouse or designated guardian understands the duties and responsibilities of the unit rear detachment.
    - (b)** Ensure your spouse or designated guardian understands how to contact the unit rear detachment officer/NCO.
  - (3)** Ensure your spouse or designated guardian is knowledgeable of the unit family support group and participates in its activities when possible.
    - (a)** Ensure your spouse or designated guardian understands the role of the family support group in providing support to family members during unit deployments.
    - (b)** Ensure your spouse or designated guardian understands the relationships among the family support group, unit rear detachment, and installation support activities.
    - (c)** Ensure your spouse or designated guardian understands how to contact the family support group coordinator for your unit.
    - (d)** Encourage your spouse to participate in family support group activities both prior to deployment and after deployment.
  - b.** Ensure your spouse or designated guardian knows how to obtain assistance from installation activities and programs (or community activities and programs for Reserve Component soldiers) available to provide assistance in your absence.
    - (1)** Financial counseling: Army Community Service (ACS), local legal aid center, or other local programs.
    - (2)** Marital counseling: Chaplain/pastor or community mental health service.
    - (3)** Drug or alcohol abuse: Community Counseling Center (CCC), Alcohol and Drug Abuse Prevention and Control Program (ADAPCP), Alcoholics Anonymous, or other local programs.
    - (4)** Mental health: Community mental health service, hospital, local Public Health Service, or local professional counselors.
    - (5)** Spiritual guidance: Installation chapel or local church.
    - (6)** Death and illness notification: Red Cross.
    - (7)** Stress management: ACS, or other local programs.
-

---

**Performance Steps**

---

(8) Family abuse: ACS, community mental health service, hospital, chaplain, local department of social services or other local programs.

(9) Legal Assistance: Army Emergency Relief (AER), ACS loan closet/food locker, Salvation Army, or other local programs.

---

**Evaluation Preparation:**

*Setup:* Evaluate soldier on his knowledge of support activities available for family members during separations or emergencies and actions that he should accomplish prior to a separation or emergency to ensure family readiness. Give the soldier a scenario that directs his deployment and will provide information necessary to have soldier identify support activities and actions that he should take to ensure family readiness. Have paper, pencil, and installation telephone book available.

**Brief Soldier:** Tell the soldier that he will be evaluated on his ability to identify support activities and personal actions that should be completed prior to deployments to ensure his family is prepared for separation or emergencies.

Performance Measures	GO	NO GO
1. Prepared his family to take care of day-to-day business and challenges they may face during a separation.	—	—
a. Took positive and proactive steps to prepare his family for separation.		
(1) Enrolled spouse in the local installation Army Family Team Building Course.		
(2) Developed a family readiness checklist.		
b. Ensured his spouse or designated guardian had access to and understood current personal records.		
(1) Maintained a current family care plan (when appropriate).		
(2) Ensured his spouse or designated guardian had access to valid general and/or special powers of attorney.		
c. Ensured his spouse or designated guardian had access to medical and dental records and understood medical requirements.		

<b>Performance Measures</b>	<b>GO</b>	<b>NO GO</b>
<b>d.</b> Ensured his spouse or designated guardian had access to and understood current legal affairs and business plans.		
<b>e.</b> Ensured his spouse or designated guardian had access to and understood current financial affairs.		
<b>(1)</b> Ensured his spouse or designated guardian was well versed on survivor benefits and assistance.		
<b>(2)</b> Ensured his spouse had proper authorization to write checks and access bank account(s).		
<b>(3)</b> Ensured any allotments to provide support to family members were initiated and adequate to provide support.		
<b>2.</b> Ensured his family was aware of unit and installation programs that can provide assistance during separations.	—	—
<b>a.</b> Ensured his spouse or designated guardian was knowledgeable of the unit programs available to provide assistance in his absence.		
<b>(1)</b> Attended, with his spouse or designated guardian, when possible, unit pre-deployment briefings.		
<b>(2)</b> Ensured his spouse or designated guardian was knowledgeable of the Unit Rear Detachment Command.		
<b>(3)</b> Ensured his spouse or designated guardian was knowledgeable of the unit family support group and that they participate in its activities when possible.		
<b>b.</b> Ensured his spouse or designated guardian knew how to obtain assistance from installation activities and programs (or community activities and programs for Reserve Component soldiers) to provide assistance in his absence.		

**Evaluation Guidance:** Score the soldier GO on performance measures passed. Score the soldier NO GO on any performance measure not completed or identified. The soldier must receive a GO on all the performance measures to receive a GO on this task. If the soldier receives a NO GO, show him the performance measures he missed.

**Required**  
DA Form 5304-R

**Related**  
AR 27-3



**Required**

DA Form 5305-R

**Related**

AR 600-20

AR 600-8-1

AR 608-18

AR 608-99

Users Guide-AFTB

---

**805C-PAD-1391****Comply With the Army's Equal Opportunity and Sexual Harassment Policies**

**Conditions:** You are a soldier in the U. S. Army. The soldiers with which you serve are both male and female, and represent different races, colors, religions, and national origins. You have access to AR 600-20 and AR 670-1. You have received training on the Army's equal opportunity (EO) and sexual harassment policies.

**Standards:** Complied with the Army's EO and sexual harassment policies. Acted in accordance with the Army's EO and sexual harassment policies, took actions to maintain an environment free from unlawful discrimination and sexual harassment, and reported behaviors that violate the EO and sexual harassment policies.

---

**Performance Steps**

1. Treat others with dignity and respect.
  - a. Demonstrate Army Values associated with equal opportunity.
    - (1) Display unquestionable loyalty.
    - (2) Follow your higher duty to the Army and the nation.
    - (3) Treat people as they should be treated.
    - (4) Live up to all the Army values.
  - b. Conform to the Army's EO and sexual harassment policies.
    - (1) Do not make racial or sexual comments and/or gestures.
    - (2) Do not make national origin or religious comments, jokes, slurs.
    - (3) Do not display racist or sexually offensive visual materials.
    - (4) Do not make unsolicited and unwelcome sexual contact with fellow soldiers.
    - (5) Do not stereotype fellow soldiers or make assumptions about their cultural background, race, religion, or beliefs.
    - (6) Do not use profanity or sexually oriented language.

---

**Performance Steps**

---

- (7) Do not discount the religious beliefs of fellow soldiers.
- c. Avoid belonging to extremist organizations or participating in extremist activities.
- d. Avoid engaging in intimate personal relationships with soldiers of different ranks that could disrupt unit cohesion.
- 2. Take personal actions to keep your unit free from unlawful discrimination and sexual harassment.
  - a. Promote EO and interpersonal harmony.
    - (1) Interact with soldiers of different races and genders.
    - (2) Respect the cultural background of fellow soldiers.
    - (3) Advocate fair treatment for all soldiers.
    - (4) Recognize and respect fellow soldiers' individual needs, aspirations, and capabilities.
    - (5) Communicate openly and honestly with fellow soldiers.
  - b. Make on-the-spot corrections of fellow soldiers whose behaviors are contrary to Army EO and sexual harassment policies.
    - (1) Correct soldiers using racial or sexually harassing nonverbal gestures.
    - (2) Correct soldiers using racial or sexually harassing verbal comments.
    - (3) Correct soldiers displaying racial or sexually harassing visual materials.
    - (4) Correct soldiers who physically contact other soldiers in a sexual manner.
  - c. Follow recommended techniques for dealing with sexual harassment.
- 3. Report behaviors that violate the Army's EO and sexual harassment policies.
  - a. Report to the chain of command.
  - b. Report to alternative agencies.
  - c. File an EO or sexual harassment complaint.
  - d. Report intimidation, harassment, or reprisal for making a complaint.

---

**Evaluation Preparation:**

*Setup:* This task can be tested in an administrative or field environment. Give the soldier a scenario that provides sufficient information to evaluate

his knowledge of the Army's EO and sexual harassment policies, prohibited acts, and actions that should be taken if a violation occurs.

**Brief Soldier:** Inform soldier that he will be tested on his knowledge of the Army's EO and sexual harassment policies, prohibited acts, and actions that should be taken if a violation occurs.

Performance Measures	GO	NO GO
1. Treated others with dignity and respect.	___	___
a. Demonstrated Army values associated with EO.		
(1) Displayed unquestionable loyalty.		
(2) Followed higher duty to the Army and the nation.		
(3) Treated people as they should be treated.		
(4) Lived up to all the Army values.		
b. Conformed to the Army's EO and sexual harassment policies.		
(1) Avoided making racial or sexual comments and/or gestures.		
(2) Avoided making national origin or religious comments, jokes or slurs.		
(3) Avoided displaying racial or sexually offensive visual materials.		
(4) Avoided making unsolicited and unwelcome sexual contact with fellow soldiers.		
(5) Avoided stereotyping fellow soldiers or making assumptions about their cultural background, race, religion, or beliefs.		
(6) Avoided using profanity or sexually oriented language.		
(7) Avoided discounting the religious beliefs of fellow soldiers.		
c. Avoided belonging to extremist organizations or participating in extremist activities.		
d. Avoided engaging in intimate personal relationships with soldiers of different ranks that could disrupt unit cohesion.		
2. Personally acted to keep the unit free from unlawful discrimination and sexual harassment.	___	___

Performance Measures	GO	NO GO
a. Promoted EO and interpersonal harmony.		
b. Made on-the-spot corrections of fellow soldiers whose behaviors were contrary to Army EO and sexual harassment policies.		
c. Followed recommended techniques for dealing with sexual harassment.		
3. Reported behaviors that violated the Army's EO and sexual harassment policies.	—	—

**Evaluation Guidance:** Score the soldier GO for each performance measure passed. Score the soldier NO GO for each performance measure failed. Soldier must receive a GO on all performance measures to receive a GO for the task. If the soldier receives a NO GO, show him what he did wrong.

#### References

##### Required

AR 600-13  
 AR 600-20  
 DA PAM 350-20  
 DA PAM 600-26  
 DODDIR 7050.6  
 MANUAL-MCM  
 TC 26-6

##### Related

AR 670-1

### SUBJECT AREA 2: FIRST AID

## 081-831-1000

### Evaluate a Casualty

**Conditions:** You have a casualty who has signs and/or symptoms of an injury.

**Standards:** Evaluated the casualty following the correct sequence. All injuries and/or conditions were identified. The casualty was immobilized if a neck or back injury was suspected.

---

**Performance Steps**

---

**Note.** When evaluating and/or treating a casualty, seek medical aid as soon as possible. Do not stop treatment, but, if the situation allows, send another person to find medical aid.

**WARNING**

If there are signs of chemical or biological agent poisoning, immediately mask the casualty. If it is not nerve agent poisoning, decontaminate exposed skin and gross contamination (large wet or oily spots) of the clothing or overgarments. If nerve agent poisoning, administer the antidote before decontamination. (See Task 081-831-1044.)

**WARNING**

If a broken neck or back is suspected, do not move the casualty unless to save his life.

1. Check for responsiveness.
  - a. Ask in a loud, but calm voice, "Are you okay?"
  - b. Gently shake or tap the casualty on the shoulder.
  - c. Watch for a response. If the casualty does not respond, go to step 2.
  - d. If the casualty is conscious, ask where he feels different than usual or where it hurts. Go to step 3. If the casualty is conscious but is choking and cannot talk, stop the evaluation and begin treatment. (See Task 081-831-1003.)
2. Check for breathing.
  - a. Look for rise and fall of the casualty's chest.
  - b. Listen for breathing by placing your ear about one inch above the casualty's mouth and nose.
  - c. Feel for breathing by placing your hand or cheek about 1 inch above the casualty's mouth and nose. If the casualty is not breathing, stop the evaluation and begin treatment. (See Task 081-831-1042.)

**Note.** Check for pulse during mouth-to-mouth resuscitation, as necessary.
3. Check for bleeding.

**WARNING**

In a chemically contaminated area, do not expose the wound(s).

- a. Look for spurts of blood or blood-soaked clothes.
-

---

**Performance Steps**

---

- b.** Look for entry and exit wounds.
    - c.** If bleeding is present, stop the evaluation and begin treatment as appropriate.
      - (1)** Arm or leg wound. (See Task 081-831-1032.)
      - (2)** Partial or complete amputation. (See Task 081-831-1032.)
      - (3)** Open head wound. (See Task 081-831-1033.)
      - (4)** Open abdominal wound. (See Task 081-831-1025.)
      - (5)** Open chest wound. (See Task 081-831-1026.)
  - 4.** Check for shock.
    - a.** Look for any of the following signs and/or symptoms.
      - (1)** Sweaty but cool skin (clammy skin).
      - (2)** Paleness of skin.
      - (3)** Restlessness or nervousness.
      - (4)** Thirst.
      - (5)** Loss of blood (bleeding).
      - (6)** Confusion.
      - (7)** Faster than normal breathing rate.
      - (8)** Blotchy or bluish skin, especially around the mouth.
      - (9)** Nausea and/or vomiting.
    - b.** If signs or symptoms of shock are present, stop the evaluation and begin treatment. (See Task 081-831-1005.)

<b>WARNING</b>
----------------

Leg fractures must be splinted before elevating the legs for shock. (See Task 081-831-1034.)
---

- 5.** Check for fractures.
    - a.** Look for the following signs and symptoms of a back or neck injury:
      - (1)** Pain or tenderness of the neck or back area.
      - (2)** Cuts or bruises in the neck and back area.
      - (3)** Inability of the casualty to move (paralysis or numbness).
        - (a)** Ask about the ability to move (paralysis).
        - (b)** Touch the casualty's arms and legs; ask whether he can feel your hand (numbness).
      - (4)** Unusual body or limb position.

---

**Performance Steps**

---

**WARNING**

Unless there is immediate life-threatening danger, do not move a casualty whom you suspect has a back or neck injury.

**b.** Immobilize any casualty suspected of having a neck or back injury by doing the following:

**(1)** Tell the casualty not to move.

**(2)** If a back injury is suspected, place padding under the natural arch of the casualty's back.

**(3)** If a neck injury is suspected, place a roll of cloth under the casualty's neck and put boots (filled with dirt, sand, etc.) or rocks on both sides of the head.

**c.** Check the casualty's arms and legs for open or closed fractures.

**(1)** Check for open fractures.

**(a)** Look for bleeding.

**(b)** Look for bone sticking through the skin.

**(2)** Check for closed fractures.

**(a)** Look for swelling.

**(b)** Look for discoloration.

**(c)** Look for deformity.

**(d)** Look for unusual body position.

**d.** If a fracture to an arm or leg is suspected, stop the evaluation and begin treatment. (See Task 081-831-1034.)

**6.** Check for burns.

**a.** Look carefully for reddened, blistered, or charred skin. Also check for singed clothes.

**b.** If burns are found, stop the evaluation and begin treatment. (See Task 081-831-1007.)

**7.** Check for head injury.

**a.** Look for the following signs and symptoms:

**(1)** Unequal pupils.

**(2)** Fluid from the ear(s), nose, mouth, or injury site.

**(3)** Slurred speech.

**(4)** Confusion.

**(5)** Sleepiness.

---

---

**Performance Steps**

---

- (6) Loss of memory or consciousness.
- (7) Staggering in walking.
- (8) Headache.
- (9) Dizziness.
- (10) Vomiting.
- (11) Paralysis.
- (12) Convulsions or twitches.

b. If a head injury is suspected, continue to watch for signs that would require mouth-to-mouth resuscitation (see Task 081-831-1042), treatment for shock (see Task 081-831-1005), or control of bleeding (see Task 081-831-1033).

8. Seek medical aid. Seek medical assistance as soon as possible, but do not interrupt treatment. If possible, send another person to find medical aid.

---

**Evaluation Preparation:**

*Setup:* Prepare a "casualty" for the soldier to evaluate by simulating one or more wounds or conditions. Simulate the wounds using a war wounds moulage set, casualty simulation kit, or other available materials. You can coach a "conscious casualty" to show signs of such conditions as shock or head injury and to respond to the soldier's questions about location of pain or other symptoms of injury. However, you will have to cue the soldier during evaluation of an "unconscious casualty" as to whether the casualty is breathing and describe the signs or conditions, such as shock, as the soldier is making the checks.

*Brief Soldier:* Tell the soldier to do, in order, all necessary steps to evaluate the casualty and identify all wounds and/or conditions. Tell the soldier to tell you what first aid action (give mouth-to-mouth resuscitation, bandage the wound, etc.) he would take, but that no first aid is to be performed unless a neck or back injury is found.

Performance Measures	GO	NO GO
1. Checked for responsiveness.	___	___
2. Checked for breathing, if necessary.	___	___
3. Checked for bleeding.	___	___
4. Checked for shock.	___	___



Performance Measures	GO	NO GO
5. Checked for fractures and immobilized neck or back injuries, if found.	___	___
6. Checked for burns.	___	___
7. Checked for a head injury.	___	___
8. Sought medical aid.	___	___
9. Performed all necessary steps in sequence.	___	___
10. Identified all wounds and/or conditions.	___	___

**Evaluation Guidance:** Score the soldier GO if all performance measures are passed. Score the soldier NO GO if any performance measure is failed. If the soldier scores NO GO, show what was done wrong and how to do it correctly.

#### References

**Required**

**Related**

FM 4-25.11

---

### 081-831-1003

#### Perform First Aid to Clear an Object Stuck in the Throat of a Conscious Casualty

**Conditions:** You see a conscious casualty who is having a hard time breathing because something is stuck in his throat.

**Standards:** Cleared the object from the casualty's throat. Gave abdominal or chest thrusts until the casualty could talk and breathe normally, the soldier was relieved by a qualified person, or the casualty became unconscious requiring mouth-to-mouth resuscitation.

---

#### Performance Steps

1. Determine if the casualty needs help.
    - a. If the casualty has good air exchange (able to speak or cough forcefully—may be wheezing between coughs), do not interfere except to encourage the casualty.
    - b. If the casualty has poor air exchange (weak coughing with high-pitched noise between coughs and signs of shock), continue with step 2.
-

---

### Performance Steps

---

c. If the casualty has a complete airway obstruction (cannot speak, breathe, or cough at all and may be clutching his neck and moving erratically), continue with step 2.

2. Perform abdominal or chest thrusts.

**Note.** Abdominal thrusts should be used unless the victim is in the advanced stages of pregnancy, is very obese, or has a significant abdominal wound.

a. Abdominal thrusts.

(1) Stand behind the casualty.

(2) Wrap your arms around the casualty's waist.

(3) Make a fist with one hand.

(4) Place the thumb side of the fist against the abdomen slightly above the navel and well below the tip of the breastbone.

(5) Grasp the fist with the other hand.

(6) Give quick backward and upward thrusts.

**Note.** Each thrust should be a separate, distinct movement. Thrusts should be continued until the obstruction is expelled or the casualty becomes unconscious.

b. Chest thrusts.

(1) Stand behind the casualty.

(2) Wrap your arms under the casualty's armpits and around the chest.

(3) Make a fist with one hand.

(4) Place the thumb side of the fist on the middle of the breastbone.

(5) Grasp the fist with the other hand.

(6) Give backward thrusts.

**Note.** Each thrust should be performed slowly and distinctly, and with the intent of relieving the obstruction.

3. Continue to give abdominal or chest thrusts as required. Give abdominal or chest thrusts until the obstruction is clear, you are relieved by a qualified person, or the casualty becomes unconscious.

**Note.** If the casualty becomes unconscious, perform a finger sweep and then start mouth-to-mouth resuscitation procedures.

**Note.** If the obstruction is cleared, watch the casualty closely and check for other injuries if necessary.

---

### Evaluation Preparation:

*Setup:* You need another soldier to play the part of the casualty.

*Brief Soldier:* Describe the symptoms of a casualty with good air exchange, poor air exchange, or a complete airway obstruction. Ask the soldier what should be done. Score step 1 based on the answer. Tell the soldier to do all of the first aid steps required to clear an object from the casualty's throat. Tell the soldier to demonstrate where to stand, how to position his hands, and how to position the casualty for the thrusts. The soldier must tell you how the thrusts should be done. Ensure that the soldier understands that he must not actually do the thrusts. Do not evaluate step 3 in the simulated mode.

Performance Measures	GO	NO GO
1. Determined if the casualty needs help.	___	___
2. Performed abdominal or chest thrusts as required.	___	___
3. Continued abdominal or chest thrusts as required.	___	___

**Evaluation Guidance:** Score the soldier GO if all performance measures are passed. Score the soldier NO GO if any performance measure is failed. If the soldier scores NO GO, show what was done wrong and how to do it correctly.

**References**

**Required**

**Related**

FM 4-25.11

---

**081-831-1005**

**Perform First Aid to Prevent or Control Shock**

**Conditions:** You see a casualty who is breathing. There is no uncontrolled bleeding. The casualty has one or more of the symptoms of shock.

Necessary equipment and materials: a field jacket and blanket or poncho.

**Standards:** Attempted to prevent a casualty from going into shock by correctly positioning the casualty, loosening binding clothes, calming and reassuring, and providing shade from direct sunlight during hot weather, or covering to prevent body heat loss during cold weather. Did not cause further injury to the casualty.

---

**Performance Steps**

1. Position the casualty.
    - a. Move the casualty to cover, if cover is available and the situation permits.
-

---

**Performance Steps**

---

- b.** Lay the casualty on his back unless a sitting position will allow the casualty to breathe easier.
- c.** Elevate the casualty's feet higher than the heart using a stable object so the feet will not fall.

**WARNING**

If the casualty has a fractured or broken leg, an abdominal wound, or a head wound, do not elevate the casualty's legs.

- 2. Loosen clothing at the neck, waist, or anywhere it is binding.

**WARNING**

Do not loosen clothing if in a chemical area.

- 3. Prevent the casualty from chilling or overheating.
  - a.** Cover the casualty to avoid loss of body heat and, in cold weather, place cover under as well as over the casualty. Use a blanket or clothing, or improvise a cover.
  - b.** Place the casualty under permanent or improvised shelter in hot weather to shade him from direct sunlight.

**WARNING**

Do not give the casualty anything to eat or drink.

- 4. Calm and reassure the casualty.
  - a.** Take charge and show self-confidence.
  - b.** Assure the casualty that he is being taken care of.

**WARNING**

If you must leave the casualty, turn his head to the side to prevent choking if vomiting occurs.

- 5. Seek medical aid.

**Note.** Watch the casualty closely for life-threatening conditions, check for other injuries, and seek medical aid.

---

**Evaluation Preparation:**

*Setup:* You will need another soldier to play the part of the casualty. Have the casualty lie down. You can have a canteen of water available and have the casualty say that he is thirsty while testing step 3.

*Brief Soldier:* Tell the soldier to do all necessary first aid steps to prevent shock. You can vary the test by telling the soldier whether it is hot or cold or that the casualty has a broken leg or abdominal wound to see if the soldier knows what to do. Do not evaluate step 5 in the simulated mode.

Performance Measures	GO	NO GO
1. Positioned the casualty correctly.	___	___
2. Loosened tight or binding clothes.	___	___
3. Prevented the casualty from chilling or overheating.	___	___
4. Reassured the casualty.	___	___
5. Sought medical aid.	___	___

**Evaluation Guidance:** Score the soldier GO if all performance measures are passed. Score the soldier NO GO if any performance measure is failed. If the soldier scores NO GO, show what was done wrong and how to do it correctly.

#### References

Required

Related

FM 4-25.11

---

## 081-831-1007

### Perform First Aid for Burns

**Conditions:** You see a casualty who is suffering from a burn. Necessary materials and equipment: casualty's first aid packet and canteen of water.

**Standards:** Gave first aid for a burn without causing further injury to the casualty. Eliminated the source of the burn, if necessary. Applied a field dressing lightly over the burn. The sides of the dressing were sealed and the dressing did not slip.

---

#### Performance Steps

1. Eliminate the source of the burn.

a. Thermal burns. If the casualty's clothing is on fire, cover the casualty with a field jacket or any large piece of nonsynthetic material and roll him on the ground to put out the flames.

---

---

**Performance Steps**

---

**b.** Electrical burns. If the casualty is in contact with an electrical source, turn the electricity off if the switch is nearby. If the electricity cannot be turned off, drag the casualty away from the source using any nonconductive material (rope, clothing, or dry wood).

**WARNING**

Do not touch the casualty or the electrical source with your bare hands. You will be injured too!

**WARNING**

High voltage electrical burns from an electrical source or lightning may cause temporary unconsciousness, difficulties in breathing, or difficulties with the heart (irregular heartbeat).

**c.** Chemical burns.

**WARNING**

Blisters caused by a blister agent are actually burns. Do not try to decontaminate skin where blisters have already formed. If blisters have not formed, decontaminate the skin.

**(1)** Remove liquid chemicals from the burned casualty by flushing with as much water or other nonflammable fluid as possible.

**(2)** Remove dry chemicals by carefully brushing them off with a clean, dry cloth. If large amounts of water are available, flush the area. Otherwise, apply no water.

**(3)** Smother burning white phosphorus with water, a wet cloth, or wet mud. Keep the area covered with the wet material.

**d.** Laser burns. Move the casualty away from the source while avoiding eye contact with the beam source.

**Note.** After the casualty is removed from the source of the burn, he should be monitored continually for the development of conditions that may require the performance of basic lifesaving measures.

**2.** Uncover the burn.

**WARNING**

Do not uncover the wound in a chemical environment. Exposure could cause additional harm.

---

---

**Performance Steps**

---

- a. Cut clothing covering the burned area.

<b>WARNING</b>
----------------

Do not attempt to remove clothing that is stuck to the wound. Additional harm could result.
--

- 
- b. Gently lift away clothing covering the burned area.

**Note.** Do not pull clothing over the burns.

**Note.** If the casualty's hand(s) or wrist(s) have been burned, remove jewelry (rings, watches) and place them in his pockets.

- 
- 
3. Apply a field dressing to the burn.

**Note.** If the burn is caused by white phosphorus, the dressing must be wet.

- 
- 
- 
- a. Apply the dressing, white side down, directly over the wound.
- b. Wrap the tails so that the dressing is covered and both sides are sealed.
- c. Tie the tails into a nonslip knot over the outer edge of the dressing, not over the wound.
- d. Check to make sure that the dressing is applied lightly over the burn but firmly enough to prevent slipping.

**Note.** Electricity often leaves entry and exit burns. Both burns should be treated.

- 
- 
- 
4. Observe precautions to avoid further injury.

- 
- 
- 
- 
- a. Do not break blisters.
- b. Do not apply grease or ointments to the burns.
- c. Do not place dressings over the face or genital area.

**Note.** If the casualty is conscious and not nauseated, give him small amounts of water to drink.

**Note.** Watch the casualty closely for life-threatening conditions, check for other injuries, and seek medical aid.

---

**Evaluation Preparation:**

**Setup:** You will need another soldier to play the part of the casualty. Simulate the burn(s) by marking the casualty's body with a suitable material. Provide materials appropriate for the burn being simulated (piece of rope, blanket, water, field dressing, or clean cloth). If a field dressing is used, use the same one repeatedly. If an electrical burn is being simulated, have the casualty lie on a piece of wire or rope and have enough materials available to treat two simulated burns.

*Brief Soldier:* Tell the soldier what is burning the casualty and have the soldier take appropriate action. After the soldier completes step 1, tell the soldier that the casualty is conscious and has no injuries other than burns. When testing step 2, you can vary the test by telling the soldier that clothing is stuck to the burn or that a chemical environment exists.

Performance Measures	GO	NO GO
1. Eliminated the source of the burn.	___	___
2. Uncovered the burn.	___	___
3. Applied a field dressing.	___	___

**Evaluation Guidance:** Score the soldier GO if all performance measures are passed. Score the soldier NO GO if any performance measure is failed. If the soldier scores NO GO, show what was done wrong and how to do it correctly.

#### References

**Required**

**Related**

FM 4-25.11

---

## 081-831-1008

### Perform First Aid for Heat Injuries

**Conditions:** You see a casualty who has signs and symptoms of a heat injury. The casualty has a full canteen of cool water.

**Standards:** Recognized the type of heat injury and gave appropriate first aid.

---

#### Performance Steps

1. Identify the type of heat injury.
    - a. Heat cramps symptoms.
      - (1) Muscle cramps of the arms, legs, or abdomen.
      - (2) Excessive sweating.
      - (3) Thirst.
    - b. Heat exhaustion symptoms. (The first five occur often. The others occur sometimes.)
      - (1) Profuse sweating with pale, moist, cool skin.
-



---

**Performance Steps**

---

- (2) Headache.
  - (3) Weakness.
  - (4) Dizziness.
  - (5) Loss of appetite.
  - (6) Heat cramps.
  - (7) Nausea, with or without vomiting.
  - (8) Urge to defecate.
  - (9) Chills (goose flesh).
  - (10) Rapid breathing.
  - (11) Tingling of the hands and/or feet.
  - (12) Confusion.
  - c. Heatstroke symptoms.
    - (1) Flushed, hot, dry skin.
    - (2) Headache.
    - (3) Dizziness.
    - (4) Nausea.
    - (5) Confusion.
    - (6) Weakness.
    - (7) Loss of consciousness.
    - (8) Seizures.
    - (9) Weak and rapid pulse and breathing.
  - 2. Provide the proper first aid for the heat injury.
    - a. Heat cramps.
      - (1) Move the casualty to a cool or shady area or improvise shade.
      - (2) Loosen the casualty's clothing unless in a chemical environment.
      - (3) Have the casualty slowly drink at least one canteen of cool water.
      - (4) Seek medical aid if the cramps continue.
    - b. Heat exhaustion.
      - (1) Move the casualty to a cool or shady area or improvise shade.
      - (2) Loosen or remove the casualty's clothing and boots unless in a chemical environment.
-

---

**Performance Steps**

---

- (3) Pour water on the casualty and fan him unless in a chemical environment.
- (4) Have the casualty slowly drink at least one canteen of cool water.
- (5) Elevate the casualty's legs.
- (6) Monitor the casualty until the symptoms are gone or medical aid arrives.

**Note.** If possible, the casualty should not participate in strenuous activity for the rest of the day.

**c. Heatstroke.**

<b>WARNING</b>
----------------

Heatstroke is a medical emergency that may result in death if treatment is delayed. Start cooling measures immediately and continue while waiting for transportation and during evacuation.
---

- (1) Move the casualty to a cool or shady area or improvise shade.
- (2) Loosen or remove the casualty's clothing unless in a chemical environment.
- (3) Spray or pour water on the casualty and fan him unless in a chemical environment.
- (4) Massage the casualty's arms and legs unless in a chemical environment.
- (5) Elevate the casualty's legs.
- (6) If the casualty is conscious, have him slowly drink at least one canteen of cool water.

**Note.** Watch the casualty closely for life-threatening conditions, check for other injuries, and seek medical aid.

---

**Evaluation Preparation:**

*Setup:* None.

*Brief Soldier:* Describe to the soldier the signs and/or symptoms of heat cramps, heat exhaustion, or heat stroke, and ask the soldier what type of heat injury is indicated. Then ask the soldier what should be done to treat the heat injury described.

Performance Measures	GO	NO GO
1. Identified the type of heat injury.	___	___

2. Provided the proper first aid for the heat injury. \_\_\_\_\_

**Evaluation Guidance:** Score the soldier GO if all performance measures are passed. Score the soldier NO GO if any performance measure is failed. If the soldier scores NO GO, show what was done wrong and how to do it correctly.

**References**

**Required**

**Related**

FM 4-25.11

---

## 081-831-1025

### Perform First Aid for an Open Abdominal Wound

**Conditions:** You see a casualty who has an open abdominal wound. The casualty is breathing. Necessary equipment and materials: casualty's first aid packet and material for an improvised dressing (clothing or blankets).

**Standards:** Applied a dressing to the wound following the correct sequence without causing further injury to the casualty. The dressing was secure and protected the wound without putting pressure on the bowel.

---

#### Performance Steps

1. Position the casualty by placing the casualty on his back with the knees up (flexed).
2. Uncover the wound unless clothing is stuck to the wound or in a chemical environment.

**CAUTION**

Uncovering the wound in a chemical environment or removing stuck clothing could cause additional harm.

3. Pick up any organs that are on the ground.
  - a. Use a clean, dry dressing or the cleanest material available and gently pick up the organs without touching them with your bare hands.
  - b. Place the organs on top of the casualty's abdomen.
4. Apply the casualty's field dressing.

**Note.** If the field dressing is not large enough to cover the entire wound, the inner surface of the plastic wrapper from the dressing may be used to cover the bowel before the dressing is applied. Other improvised dressings can be made from clothing, blankets, or the cleanest material available.

- a. Apply the dressing, white side down, directly over the wound.
-

---

**Performance Steps**

---

**WARNING**

Do not apply pressure to the wound or other exposed internal parts.

b. Wrap the tails around the casualty's body completely covering the dressing if possible.

c. Loosely tie the tails into a nonslip knot at the casualty's side.

d. Check to make sure the tails are tied firmly enough to prevent slipping without applying pressure to the bowel.

**Note.** Field dressings can be covered with improvised reinforcement materials (cravats, strips of torn cloth) for additional support and protection. The improvised bandages should be tied on the casualty's side—the one opposite to where the dressing is tied.

**Note.** Do not cause further injury. Observe the following:  
**Do not** touch exposed organs with bare hands.  
**Do not** push organs back inside the body.  
**Do not** probe, clean, or remove any foreign object from the wound.

**WARNING**

Do not give food or water to the casualty. (Moistening the casualty's lips is allowed.)

**Note.** Watch the casualty closely for life-threatening conditions, check for other injuries, and seek medical aid.

---

**Evaluation Preparation:**

*Setup:* Use the same field dressing repeatedly. Have another soldier act as the casualty. Use a moulage or otherwise simulate the abdominal wound. You can have a canteen of water available and have the casualty say that he is thirsty while testing step 4.

*Brief Soldier:* Tell the soldier to do, in order, all necessary first aid steps to treat the casualty's wound. When testing step 2, you can vary the test by telling the soldier that clothing is stuck to the wound or that a chemical environment exists.

Performance Measures	GO	NO GO
1. Positioned the casualty.	___	___
2. Uncovered the wound.	___	___
3. Picked up organs.	___	___

Performance Measures	GO	NO GO
4. Applied the casualty's field dressing.	___	___
5. Performed steps 1 through 4 in the correct sequence.	___	___
6. Watched the casualty closely for life-threatening conditions and checked for other injuries, if necessary. (See the Task 081-831-1000.)	___	___

**Evaluation Guidance:** Score the soldier GO if all performance measures are passed. Score the soldier NO GO if any performance measure is failed. If the soldier scores NO GO, show what was done wrong and how to do it correctly.

#### References

**Required**

**Related**

FM 4-25.11

---

## 081-831-1026

### Perform First Aid for an Open Chest Wound

**Conditions:** You see a casualty who has an open chest wound. The casualty is breathing. Necessary equipment and materials: casualty's first aid packet and material to improvise a dressing (clothing or blankets).

**Standards:** Applied a dressing to the wound following the correct sequence, without causing further injury to the casualty. The wound was properly sealed and the dressing was firmly secured without interfering with breathing.

---

#### Performance Steps

**Note.** If there are two wounds, the same procedure should be followed for both. Start with the one that is more serious; (the one that has the heavier bleeding or is larger).

1. Uncover the wound unless clothing is stuck to the wound or in a chemical environment.

**CAUTION**

Uncovering the wound in a chemical environment or removing stuck clothing could cause additional harm.

**WARNING**

Do not attempt to clean the wound.

---

**Performance Steps**

---

2. Apply airtight material over the wound.
  - a. Use the fully opened outer wrapper of the casualty's field dressing or other airtight material.
  - b. Apply the inner surface of the airtight material directly over the wound after the casualty exhales completely.

**Note.** When applying the airtight material try not to touch the inner surface.

  - c. Hold the material in place.
3. Apply the casualty's field dressing.
  - a. Apply the dressing, white side down, directly over the airtight material.
  - b. Have the casualty breathe normally.
  - c. Maintain pressure on the dressing while you wrap the tails around the body back to the starting point.
  - d. Tie the tails into a nonslip knot over the center of the dressing after the casualty has exhaled completely.
  - e. Check to make sure the knot is tied firmly enough to secure the dressing without interfering with breathing.

**Note.** When practical, apply direct manual pressure over the dressing for 5 to 10 minutes to help control the bleeding.
4. Position the casualty on the injured side or in a sitting position, whichever makes breathing easier.

**WARNING**

If the casualty's condition (difficulty in breathing, shortness of breath, restlessness, or blueness of skin) worsens after placing the dressing, quickly lift or remove and then replace the airtight dressing.

**Note.** Watch the casualty for life-threatening conditions, check for other injuries, and seek medical aid.

---

**Evaluation Preparation:**

**Setup:** Use the same field dressing repeatedly. Prepare the field dressing outer wrapper or provide a piece of airtight material (plastic, cellophane, foil). Have another soldier act as the casualty. Use a moulage or otherwise simulate the chest wound.

**Brief Soldier:** Tell the soldier to do, in order, all necessary first aid steps to treat the casualty's wound. When testing step 1, you can vary the test by telling the soldier that clothing is stuck to the wound or that a chemical environment exists.

<b>Performance Measures</b>	<b>GO</b>	<b>NO GO</b>
<b>1.</b> Uncovered the wound unless clothing is stuck to the wound or a chemical environment exists.	—	—
<b>2.</b> Applied airtight material over the wound without touching the inner surface.	—	—
<b>a.</b> Used the fully opened outer wrapper of the casualty's field dressing or other airtight material.		
<b>b.</b> Applied the inner surface of the airtight material directly over the wound after the casualty exhaled completely.		
<b>c.</b> Held the material in place.		
<b>3.</b> Applied the casualty's field dressing.	—	—
<b>a.</b> Applied the dressing, white side down, directly over the airtight material.		
<b>b.</b> Had the casualty breathe normally.		
<b>c.</b> Maintained pressure on the dressing while wrapping the tails around the body back to the starting point.		
<b>d.</b> Tied the tails into a nonslip knot over the center of the dressing, after the casualty exhaled completely.		
<b>e.</b> Checked to make sure the knot is tied firmly enough to secure the dressing without interfering with breathing.		
<b>4.</b> When practical, applied direct manual pressure over the dressing for 5 to 10 minutes to help control the bleeding.	—	—
<b>5.</b> Positioned the casualty on the injured side or in a sitting position, whichever made breathing easier.	—	—
<b>6.</b> Performed steps 1 through 5 in the correct sequence.	—	—

**Evaluation Guidance:** Score the soldier GO if all performance measures are passed. Score the soldier NO GO if any performance measure is failed. If the soldier scores NO GO, show what was done wrong and how to do it correctly.

#### **References**

**Required**

**Related**

FM 4-25.11

081-831-1026

3-71

---

## 081-831-1032

### Perform First Aid for Bleeding of an Extremity

**Conditions:** You have a casualty who has a bleeding wound of the arm or leg. The casualty is breathing. Necessary equipment and materials: casualty's first aid packet, materials to improvise a pressure dressing (wadding and cravat or strip of cloth), materials to elevate the extremity (blanket, shelter half, poncho, log, or any available material), rigid object (stick, tent peg, or similar object), and a strip of cloth.

**Standards:** Controlled bleeding from the wound following the correct sequence. Placed a field dressing over the wound with the sides of the dressing sealed so it did not slip. Checked to ensure the field and pressure dressing did not have a tourniquet-like effect. Applied a tourniquet to stop profuse bleeding not stopped by the dressings, or for missing arms and legs.

---

#### Performance Steps

1. Uncover the wound unless clothing is stuck to the wound or in a chemical environment.

**WARNING**

Do not remove protective clothing in a chemical environment. Apply dressings over the protective clothing.

**Note.** If an arm or leg has been cut off, go to step 5.

2. Apply the casualty's field dressing.
  - a. Apply the dressing, white side down, directly over the wound.
  - b. Wrap each tail, one at a time, in opposite directions around the wound so the dressing is covered and both sides are sealed.
  - c. Tie the tails into a nonslip knot over the outer edge of the dressing, not over the wound.
  - d. Check the dressing to make sure it is tied firmly enough to prevent slipping without causing a tourniquet-like effect.

**WARNING**

Field and pressure dressings should not have a tourniquet-like effect. The dressing must be loosened if the skin beyond the injury becomes cool, blue, or numb.

3. Apply manual pressure and elevate the arm or leg to reduce bleeding, if necessary.



---

**Performance Steps**

---

- a. Apply firm manual pressure over the dressing for 5 to 10 minutes.
  - b. Elevate the injured part above the level of the heart unless a fracture is suspected and has not been splinted.
4. Apply a pressure dressing if the bleeding continues.
- a. Keep the arm or leg elevated.
  - b. Place a wad of padding directly over the wound.
  - c. Place an improvised dressing over the wad of padding and wrap it tightly around the limb.
  - d. Tie the ends in a nonslip knot directly over the wound.
  - e. Check the dressing to make sure it does not have a tourniquet-like effect.

**Note.** If the bleeding stops, watch the casualty closely, and check for other injuries.

**Note.** If heavy bleeding continues, apply a tourniquet.

**WARNING**

The only time a tourniquet should be applied is when an arm or leg has been cut off or when heavy bleeding cannot be stopped by a pressure dressing. If only part of a hand or foot has been cut off, the bleeding should be stopped using a pressure dressing.

5. Apply a tourniquet.
- a. Make a tourniquet at least two inches wide.
  - b. Position the tourniquet.
    - (1) Place the tourniquet over the smoothed sleeve or trouser leg if possible.
    - (2) Place the tourniquet around the limb two to four inches above the wound between the wound and the heart but not on a joint or directly over a wound or a fracture.
    - (3) Place the tourniquet just above, and as close to the joint as possible, when wounds are just below a joint.
  - c. Put on the tourniquet.
    - (1) Tie a half knot.
    - (2) Place a stick (or similar object) on top of the half knot.
    - (3) Tie a full knot over the stick.
    - (4) Twist the stick until the tourniquet is tight around the limb and bright red bleeding has stopped.
-

---

**Performance Steps**

---

**Note.** In case of an amputation, dark oozing blood may continue for a short time.

d. Secure the tourniquet. The tourniquet can be secured using the ends of the tourniquet band or with another piece of cloth as long as the stick does not unwind.

**Note.** If a limb is completely amputated, the stump should be padded and bandaged (do not cover the tourniquet).

**Note.** If possible, severed limbs or body parts should be saved and transported with, but out of sight of, the casualty. The body parts should be wrapped in dry, sterile dressing and placed in a dry, plastic bag and in turn placed in a cool container (do not soak in water or saline or allow to freeze). It is entirely possible that your location in the field/combat may not allow for the correct preserving of parts; do what you can.

<b>WARNING</b>
----------------

Do not loosen or release a tourniquet once it has been applied.
---

e. Mark the casualty's forehead with a letter T using a pen, mud, the casualty's blood, or whatever is available.

6. Watch the casualty closely for life-threatening conditions, check for other injuries, if necessary, and treat for shock.

---

**Evaluation Preparation:**

**Setup:** Use the same field dressing repeatedly. Have materials available for a pressure dressing (wadding and cravat or a strip of cloth). Have one soldier play the part of the casualty and another apply the field and pressure dressing. Use a moulage or mark a place on the casualty's arm or leg to simulate a wound. For applying a tourniquet, use a mannequin or simulated arm or leg (padded length of 2-inch by 4-inch wood with a glove or boot on one end) with a field dressing appropriately placed on the arm or leg. Under no circumstances will a live simulated casualty be used to evaluate the application of a tourniquet. Place the tourniquet materials (a stick and one or two pieces of cloth) nearby.

**Brief Soldier:** Tell the soldier to do, in order, the first aid steps required to put on a field dressing and, if necessary, a pressure dressing on the casualty's wound. When testing step 1, you can vary the test by telling the soldier that clothing is stuck to the wound or that a chemical environment exists. After step 2 and 3, tell the soldier that the bleeding has not stopped. After step 4, tell the soldier the bleeding is continuing and ask the soldier to describe and perform first aid on the simulated arm or leg provided.

Performance Measures	GO	NO GO
1. Uncovered the wound.	___	___
2. Applied a field dressing.	___	___
3. Applied manual pressure and elevated the arm or leg, if necessary.	___	___
4. Applied a pressure dressing, if necessary.	___	___
5. Applied a tourniquet, if necessary.	___	___
6. Performed steps 1 through 5, as necessary, in sequence.	___	___

**Evaluation Guidance:** Score the soldier GO if all performance measures are passed. Score the soldier NO GO if any performance measure is failed. If the soldier scores NO GO, show what was done wrong and how to do it correctly.

**References**

**Required**

**Related**

FM 4-25.11

---

**081-831-1033**

**Perform First Aid for an Open Head Wound**

**Conditions:** You see a casualty who has an open head wound. The casualty is breathing. Necessary equipment and materials: casualty's first aid packet and a canteen of water.

**Standards:** Applied a dressing to the wound following the correct sequence without causing further injury to the casualty. The casualty was properly positioned and the dressing was secured without applying unnecessary pressure.

---

**Performance Steps**

1. Check the casualty's level of consciousness.
    - a. Question the casualty.
      - (1) "What is your name?"
      - (2) "Where are you?"
      - (3) "What is today's date (day, month, year)?"
-

---

**Performance Steps**

---

b. Report incorrect answers, inability to answer, or changes in answers to medical personnel.

2. Position the casualty.

**WARNING**

Do not move the casualty if he exhibits signs and/or symptoms, other than minor bleeding, of a neck, spine, or severe head injury.

a. The casualty is conscious or has a minor scalp wound.

(1) Have the casualty sit up unless other injuries prohibit sitting up.

(2) Raise the head slightly if the casualty is lying down and is not accumulating fluids in his throat.

(3) Turn his head to the side or position the casualty on his side (opposite the wound) if the wound is bleeding into the mouth or throat.

b. The casualty is unconscious or has a severe head injury.

(1) Treat the casualty as having a potential neck or spinal injury. Immobilize and do not move the casualty unless absolutely necessary.

(2) Turn the casualty, if he is choking and/or vomiting or bleeding into the mouth. Position the casualty on his side opposite the wound.

**WARNING**

If it is necessary to turn a casualty with a suspected neck or spinal injury, assistance will be required. Roll the casualty gently onto his side keeping the head, neck, and body aligned while providing support for the head and neck.

3. Expose the wound by removing the casualty's helmet if necessary.

**WARNING**

In a chemical environment removing the mask or other protective clothing could be hazardous to the casualty.

**Note.** In a chemical environment—

– If the casualty's mask and hood are not breached, do not apply a dressing. If the all clear has not been given, do not remove the casualty's mask to treat the wound.

– If the casualty's mask or hood has been breached, and the all clear has not been given, attempt to repair the breach with tape or wet cloth stuffing. Do not apply a dressing.

– If the casualty's mask or hood has been breached and the all clear has been given, remove the mask to apply a dressing.

---

---

**Performance Steps**

---

**4. Apply the casualty's field dressing to the wound.****WARNING**

To prevent further injury to the casualty—

**Do not** try to clean the wound.

**Do not** put unnecessary pressure on the wound.

**Do not** try to push brain matter back into the head.

**Do not** give the casualty any food or drink.

**Do not** move the casualty if a broken neck or broken back is suspected.

**a. Forehead or back of the head.**

**(1)** Apply the dressing, white side down, directly over the wound with the tails extending toward the sides of the head.

**(2)** Wrap the tails, one at a time, around the head in opposite directions making sure the tails cover the dressing but not the eyes and ears.

**(3)** Tie the tails at the side of the head using a nonslip knot.

**b. Top of the head.**

**(1)** Apply the dressing, white side down, directly over the wound.

**(2)** Wrap one tail down under the chin and bring it up in front of the ear over the dressing to a point just above, and in front of, the opposite ear.

**(3)** Wrap the other tail down under the chin in the opposite direction and up the side of the head to meet the first tail.

**(4)** Cross the tails.

**(5)** Wrap one tail across the forehead above the eyebrows to a point just above and in front of the opposite ear.

**(6)** Wrap the other tail above the ear, low over the back of the head, and above the opposite ear to meet the other tail.

**(7)** Tie the tails using a nonslip knot.

**c. Side of the head or cheek.**

**(1)** Apply the dressing, white side down, directly over the wound with the tails extending up and down.

**(2)** Wrap the top tail over the top of the head, down in front of the ear, under the chin, and up over the dressing to a point just above the ear.

---

---

**Performance Steps**

---

- (3) Wrap the other tail in the opposite direction to meet the first tail.
  - (4) Cross the tails and complete the procedure as follows:
    - (a) Wrap one tail across the forehead above the eyebrows to a point just above, and in front of, the opposite ear.
    - (b) Wrap the other tail above the ear, low over the back of the head, and above the opposite ear to meet the other tail.
    - (c) Tie the tails using a nonslip knot.
  - 5. Monitor the casualty.
    - a. Check the casualty's level of consciousness every 15 minutes.
    - b. Awaken the casualty every 15 minutes if he falls asleep.
    - c. Note any changes from earlier checks.
  - 6. Watch the casualty for life-threatening conditions and check for other injuries, if necessary.
- 

**Evaluation Preparation:**

*Setup:* Use the same field dressing repeatedly. Have another soldier act as the casualty. Use a moulage or otherwise simulate a wound to the forehead, back of the head, side of the head, cheek, or top of the head. Brief the casualty on how to answer the soldier's questions during step 1. You can have a canteen of water available and have the casualty say that he is thirsty to see if the soldier knows what to do.

*Brief Soldier:* Tell the soldier to do, in order, all necessary first aid steps to treat the casualty's wound. Tell the soldier that it is not in a chemical environment. After the soldier completes step 4, ask him how often the casualty's level of consciousness should be checked and what should be done if the casualty falls asleep. Score step 5 based on the soldier's responses.

Performance Measures	GO	NO GO
1. Checked the casualty's level of consciousness.	___	___
2. Positioned the casualty.	___	___
3. Exposed the wound.	___	___
4. Applied the casualty's field dressing.	___	___
5. Monitored the casualty.	___	___
6. Performed steps 1 through 5 in the correct sequence.	___	___

**Evaluation Guidance:** Score the soldier GO if all performance measures are passed. Score the soldier NO GO if any performance measure is failed. If the soldier scores NO GO, show what was done wrong and how to do it correctly.

**References**

**Required**

**Related**

FM 4-25.11

---

**081-831-1034**

**Perform First Aid for a Suspected Fracture**

**Conditions:** You see a casualty who has an arm or leg that you think is broken. The casualty has no more serious wounds or conditions that have not been treated. Necessary materials and equipment: splint materials (boards, poles, tree branches), padding materials (clothing, blanket, field dressing, leafy vegetation), and tie materials (strips of cloth, belts).

**Standards:** Splinted the suspected broken arm or leg so the arm or leg did not move and circulation was not impaired.

---

**Performance Steps**

1. Prepare the casualty for splinting.
  - a. Reassure the casualty if he is conscious and able to understand. Tell the casualty you will be taking care of him.
  - b. Loosen any tight or binding clothing.

**WARNING**

Do not remove any protective clothing or boots in a chemical environment. Apply the splint over the clothing.

**WARNING**

Do not remove boots from the casualty unless they are needed to stabilize a neck injury or there is actual bleeding from the foot.

- c. Remove all jewelry from the affected limb and place it in the casualty's pocket. Tell the casualty that you are doing this to prevent further injury if swelling occurs later.
2. Get splinting materials.
  - a. Get splints (wooden boards, tree branches, poles, an unloaded rifle) long enough to reach beyond the joints above and below the broken part.

---

**Performance Steps**

---

**b.** Get materials to pad the splints, such as a jacket, blanket, poncho, shelter half, or leafy vegetation.

**c.** Get tie materials, such as strips of cloth or belts, to tie the splints.

**Note.** If splinting materials are not available, use the chest wall to immobilize a suspected fracture of the arm and an uninjured leg to immobilize the fractured leg. Continue with steps 7 and 8.

**3.** Pad the splints. Apply padding between the splint and the bony areas of the body. Suggested sites for padding: wrist, elbow, ankle, knee, crotch, and armpit.

**4.** Check for signs of blood circulation problems below the injury.

**a.** Check light-skinned persons for color of skin (skin may be pale, white, or a bluish gray color).

**b.** Check dark-skinned persons by depressing the toenail or fingernail beds and seeing how fast the color returns. A slower return of color to the injured side indicates a circulation problem.

**c.** Check to see if the injured arm or leg feels colder than the uninjured one.

**d.** Ask the casualty about the presence of numbness, tightness, or a cold sensation.

**WARNING**

If there is a blood circulation problem, evacuate the casualty as soon as possible.

**5.** Put on a splint.

**WARNING**

If the fracture is open, do not attempt to push bones back under the skin. Apply a field dressing to protect the area.

**a.** Splint the broken arm or leg in the position in which you find it.

**Note.** Do not try to reposition or straighten the fracture.

**b.** Place one splint on each side of the arm or leg. Make sure the splints reach beyond the joints above and below the fracture.

**c.** Tie the splints with improvised (or actual) cravats.

**(1)** Gently place the cravats at a minimum of two points above and two points below the fracture if possible.

---



---

**Performance Steps**

---

**WARNING**

Do not tie any cravats directly over the fracture.

- (2) Tie nonslip knots on the splint away from the injury.
6. Check the splint for tightness.
- a. Make sure the cravats are tight enough to hold the splinting materials securely in place.
  - b. Recheck circulation below the injury to make sure circulation is not impaired.
  - c. Make any adjustments without allowing the splint to become ineffective.
7. Apply sling if applicable.
- Note.** A sling can be used to further immobilize an arm and to provide support by the uninjured side.
- a. Make a sling from any nonstretching material such as a strip of clothing or blanket, poncho, shelter half, belt, or shirttail.
  - b. Apply the sling so the supporting pressure is on the casualty's uninjured side.
  - c. Make sure the hand of the supported arm is slightly higher than the elbow.
8. Apply swathes if applicable.
- Note.** Apply swathes when the casualty has a splinted, suspected fracture of the elbow or leg, or when a suspected fracture cannot be splinted. (Improvise swathes from large pieces of cloth or belts.)

**WARNING**

Place swathes above and/or below the fracture, not over it.

- a. Apply swathes to an injured arm by wrapping the swathes over the injured arm, around the casualty's back, and under the arm on the uninjured side. Tie the ends on the uninjured side.
  - b. Apply swathes to an injured leg by wrapping the swathes around both legs and tying the swathes on the uninjured side.
- Note.** Watch the casualty closely for life-threatening conditions, check for other injuries, and seek medical aid.
-

### Evaluation Preparation:

*Setup:* You will need another soldier to play the part of the casualty. Have the casualty lie down or sit. Place splinting materials nearby. Have available splints, padding, and materials for ties, slings, and swathes that are appropriate to the fracture location on the arm or leg. If available, have two or more pairs of splints of varying lengths to help in scoring step 1.

*Brief Soldier:* Tell the soldier that the casualty has a suspected closed fracture and where it is located (lower arm, elbow, upper leg, lower leg). Tell the soldier to splint the suspected fracture. Do not evaluate step 8 in the simulated mode.

Performance Measures	GO	NO GO
1. Used splints that reach beyond the joints above and below the fracture.	___	___
2. Checked blood circulation below the fracture before and after applying the splints.	___	___
3. Applied padding between the splints and all bony areas.	___	___
4. Used at least four ties (two above and two below the fracture) to secure the splints, if possible.	___	___
5. Tied nonslip knots on the splint away from the injury.	___	___
6. Immobilized the splinted arm or leg using a sling and/or swathes, as required, to prevent easy movement.	___	___
7. Checked the splint for tightness.	___	___
8. Watched the casualty for life-threatening conditions and checked for other injuries.	___	___

**Evaluation Guidance:** Score the soldier GO if all performance measures are passed. Score the soldier NO GO if any performance measure is failed. If the soldier scores NO GO, show what was done wrong and how to do it correctly.

### References

Required

Related

FM 4-25.11

---

## 081-831-1042

### Perform Mouth-to-Mouth Resuscitation

**Conditions:** You see an adult casualty who is unconscious and does not appear to be breathing. You are not in a chemical environment.

**Standards:** Gave mouth-to-mouth resuscitation correctly, in the correct sequence. Continued mouth-to-mouth resuscitation at the rate of about 10 to 12 breaths per minute until the casualty started to breathe on his own, the soldier was relieved by a qualified person, or the soldier was too tired to go on.

**Note:** The standard is based on American Heart Association information.

---

#### Performance Steps

---

1. Roll the casualty onto his back if necessary.

**WARNING**

The casualty should be carefully rolled as a whole, so the body does not twist.

2. Open the airway.

**Note.** If foreign material or vomit is in the mouth, it should be removed as quickly as possible (see step 7).

**a.** Head-tilt/chin-lift method.

- (1) Kneel at the level of the casualty's shoulders.
- (2) Place one hand on the casualty's forehead and apply firm, backward pressure with the palm to tilt the head back.
- (3) Place the fingertips of the other hand under the bony part of the lower jaw and lift, bringing the chin forward.

**Note.** Do not use the thumb to lift.

**Note.** Do not press deeply into the soft tissue under the chin with the fingers.

**b.** Jaw-thrust method.

**Note.** This method is usually used for casualties with a neck or severe head injury.

- (1) Kneel above the casualty's head (looking toward the casualty's feet).
  - (2) Rest your elbows on the ground or floor.
  - (3) Place one hand on each side of the casualty's head and place the tips of the index and middle fingers under the angles of the casualty's lower jaw. Place your thumbs on the jaw just below the level of the teeth.
-

---

**Performance Steps**

---

**(4)** Raise your fingertips to lift the jaw forward (upward). This action will also cause the casualty's head to tilt backward somewhat.

**Note.** If the casualty's lips are still closed after the jaw has been moved forward, use your thumbs to retract the lower lip and allow air to enter the casualty's mouth.

**3.** Check for breathing.

**a.** Check for breathing within 3 to 5 seconds by placing an ear over the casualty's mouth and looking toward his chest.

**b.** Look for the chest to rise and fall.

**c.** Listen for sounds of breathing.

**d.** Feel for breath on your cheek.

**Note.** If the casualty resumes breathing at any time during this procedure, the airway should be kept open and the casualty should be monitored. If the casualty continues to breathe, he should be transported to medical aid. Otherwise, the procedure should be continued.

**4.** Give breaths to ensure an open airway.

**Note.** When mouth-to-mouth resuscitation breathing cannot be performed because the casualty has jaw injuries or spasms, the mouth-to-nose method may be more effective.

**Note.** Perform the mouth-to-nose method by blowing into the nose while holding the lips closed. Let air escape by removing your mouth and, in some cases, removing your mouth and separating the casualty's lips.

**a.** Maintain the airway and gently pinch the nose closed, using the hand on the casualty's forehead.

**b.** Take a deep breath and place your mouth, in an airtight seal, around the casualty's mouth.

**c.** Give two full breaths (1 ½ to 2 seconds each), taking a breath between them, while watching for the chest to rise and fall and listening and/or feeling for air to escape during exhalation.

**Note.** If chest rises, go to step 8.

**Note.** If chest does not rise, continue with step 5.

**5.** Reposition the casualty's head slightly farther backward and repeat the breaths.

**Note.** If chest rises, go to step 8.

**Note.** If chest does not rise, continue with step 6.

**6.** Perform abdominal or chest thrusts.

---

---

**Performance Steps**

---

**Note.** Abdominal thrusts should be used unless the casualty is in the advanced stages of pregnancy, is very obese, or has a significant abdominal wound.

**a.** Abdominal thrusts.

- (1) Kneel astride the casualty's thighs.
- (2) Place the heel of one hand against the casualty's abdomen, slightly above the navel but well below the tip of the breastbone, with the fingers pointing toward the casualty's head.
- (3) Place the other hand on top of the first.
- (4) Press into the abdomen with a quick forward and upward thrust.

**Note.** Each thrust should be a separate, distinct movement.

- (5) Give several thrusts (up to five).

**b.** Chest thrusts.

- (1) Kneel close to the side of the casualty's body.
- (2) Locate the lower edge of the casualty's ribs and run the fingers up along the rib cage to the notch where the ribs meet the breastbone.
- (3) Place the middle finger on the notch with the index finger just above it on the lower end of the breastbone.
- (4) Place the heel of the other hand on the lower half of the breastbone next to the two fingers.
- (5) Remove the fingers from the notch and place that hand on top of the other hand, extending or interlacing the fingers.
- (6) Straighten and lock the elbows with the shoulders directly above the hands.
- (7) Without bending the elbows, rocking, or allowing the shoulders to sag, apply enough pressure to depress the breastbone 1 to 2 inches.

**Note.** Each thrust should be given slowly, distinctly, and with the intent of relieving the obstruction.

- (8) Give several thrusts (up to five).

**7.** Perform a finger sweep and repeat breaths.

- a.** Open the mouth by grasping the tongue and lower jaw to lift the jaw open or crossing the fingers and thumb to push the teeth apart.
  - b.** Insert the index finger of the other hand down along the cheek to the base of the tongue.
  - c.** Use a hooking motion from the side of the mouth toward the center to dislodge the object.
-

---

**Performance Steps**

---

**WARNING**

Take care not to force the object deeper into the airway.

d. Reopen the airway and repeat the breaths.

**Note.** If chest rises, go to step 8.

**Note.** If chest does not rise, repeat steps 6 and 7 until the airway is clear.

8. Check for a pulse for 5 to 10 seconds.

**Note.** Use the first two fingers in the groove in the casualty's throat beside the Adam's apple. Do not use the thumb.

a. If a pulse is found but the casualty is not breathing, continue with step 9.

b. If no pulse is found, cardiopulmonary resuscitation (CPR) must be performed by qualified personnel. Send for qualified medical personnel.

9. Continue mouth-to-mouth resuscitation, at the rate of about 10 to 12 breaths per minute.

10. Recheck for pulse and breathing for 3 to 5 seconds after every 12 breaths.

**Note.** Once breathing is restored, watch the casualty closely, maintain an open airway, and check for other injuries.

---

**Evaluation Preparation:**

**Setup:** For training and testing, you must use a resuscitation training mannequin (DVC 08-15). Have a bottle of alcohol and swabs or cotton available. Place the mannequin on the floor and alcohol and cotton balls on the table. Clean the mannequin's nose and mouth before each soldier is evaluated.

**Brief Soldier:** Tell the soldier to do, in order, all necessary steps to restore breathing. After step 3, tell the soldier that the casualty is not breathing. When testing steps 4 and 5, you can vary the test by indicating whether the chest rises or not. If step 7 is tested, tell the soldier that the airway is open. You can stop the evaluation when the soldier rechecks for the pulse in step 10.

**Note:** Reference made to the mouth-to-nose method within the task presents information on an alternate procedure that must be used under some circumstances. This method will not be evaluated.

Performance Measures	GO	NO GO
1. Positioned the casualty.	___	___

Performance Measures	GO	NO GO
2. Opened the airway using the head-tilt/chin-lift method.	___	___
3. Checked for breathing.	___	___
4. Gave breaths to ensure an open airway.	___	___
5. Repositioned the casualty's head and repeated breaths, if necessary.	___	___
6. Performed abdominal thrusts or chest thrusts, if necessary.	___	___
7. Performed a finger sweep and repeated breaths if necessary.	___	___
8. Checked for pulse.	___	___
9. Continued mouth-to-mouth or mouth-to-nose resuscitation.	___	___
10. Rechecked for pulse and breathing after every 12 breaths.	___	___
11. Performed all necessary steps in the correct sequence.	___	___

**Evaluation Guidance:** Score the soldier GO if all performance measures are passed. Score the soldier NO GO if any performance measure is failed. If the soldier scores NO GO, show what was done wrong and how to do it correctly.

**References**

**Required**

**Related**

FM 4-25.11

---

**081-831-1044**

**Perform First Aid for Nerve Agent Injury**

**Conditions:** You and your unit have come under a chemical attack. You are wearing protective overgarments and/or mask, or they are immediately available. There are casualties with nerve agent injuries. Necessary materials and equipment: chemical protective gloves, overgarments, overboots, protective mask and hood, mask carrier, and nerve agent antidote autoinjectors. The casualty has three sets of MARK I nerve agent antidote autoinjectors or three antidote treatment nerve agent autoinjector

(ATNAAs) and one convulsant antidote for nerve agents (CANA) autoinjector.

**Standards:** Administered correctly the antidote to self, or administered three sets of MARK I nerve agent antidote autoinjectors or three ATNAAs followed by the CANA to a buddy following the correct sequence.

---

**Performance Steps**

---

**Note.** The ATNAA system is a nerve agent antidote device that will be used by the armed forces. A single ATNAA delivers both the atropine and 2 Pam Cl. The ATNAA will replace the MARK I when supplies are exhausted. Procedures for administering ATNAA will be contained in FM 4-25.11 (FM 21-11) and FM 8-285.

**Note.** When performing first aid on a casualty, seek medical aid as soon as possible. Do not stop the first aid; if the situation allows, send another person to find medical aid.

1. Identify mild signs and symptoms of nerve agent poisoning.
  - a. Unexplained runny nose.
  - b. Unexplained sudden headache.
  - c. Excessive flow of saliva (drooling).
  - d. Tightness of the chest causing breathing difficulties.
  - e. Difficulty seeing (blurred vision).
  - f. Muscular twitching around area of exposed or contaminated skin.
  - g. Stomach cramps.
  - h. Nausea.

**Note.** For the above signs and symptoms first aid is considered to be self-aid.

2. React to the chemical hazard.
  - a. Put on your protective mask.

**Note.** Seek overhead cover or use a poncho to provide cover, mission permitting. Do not put on additional protective clothing at this time. Give yourself the nerve agent antidote first. Then, decontaminate exposed skin areas and put on remaining protective clothing.

- b. Give the alarm.
3. Administer nerve agent antidote to self (self-aid), if necessary.
  - a. MARK I.

**(1)** Prepare to administer one atropine injection.

**(a)** Remove one set of MARK I from your protective mask carrier, from the pocket of the MOPP suit, or from another location as specified by your unit SOP.

**(b)** With one hand, hold the set of injectors by the plastic clip with the big injector on top.

---



---

**Performance Steps**

---

(c) With the other hand, check the injection site in order to avoid buttons and objects in pockets where injecting. For injections into the thigh, grasp the trouser cargo pocket and pull forward, clearing possible obstructions from the site.

(d) Grasp the small injector without covering or holding the needle (green) end, and pull it out of the clip with a smooth motion.

(e) Form a fist around the autoinjector with the needle end (green) extending beyond the little finger end of the fist. Be careful not to inject yourself in the hand.

**Note.** If the injection is accidentally given in the hand, another small injector must be obtained and the injection given in the proper site.

(f) Place the needle end of the injector against the outer thigh muscle. For injections into the thigh, grasp the trouser cargo pocket and pull forward, clearing possible obstructions from the site.

**Note.** The injection can be given in any part of the lateral thigh muscle from about a hand's width above the knee to a hand's width below the hip joint.

**Note.** Very thin soldiers should give the injection in the upper outer part of the buttocks.

**CAUTION**

When injecting antidote in the buttocks, be very careful to inject only into the upper, outer quarter of the buttocks to avoid hitting the major nerve that crosses the buttocks. Hitting the nerve may cause paralysis.

(2) Administer the atropine injection.

(a) Push the injector into the muscle with firm, even pressure until it functions.

**Note.** A jabbing motion is not necessary to trigger the activating mechanism.

(b) Hold the injector firmly in place for at least 10 seconds.

(c) Remove the injector from your muscle and carefully place the used injector between two fingers of the hand holding the plastic clip.

(3) Prepare to administer one 2 PAM CI injection.

(a) Pull the large injector out of the clip and form a fist around the autoinjector with the needle end extending beyond the little finger.

(b) Place the needle (black) end of the injector against the injection site.

(4) Administer the 2 Pam CI injection.

(a) Push the injector into the muscle with firm, even pressure until it functions.

---

---

**Performance Steps**

---

(b) Hold the injector firmly in place for at least 10 seconds.

**b. ATNAA.**

(1) Prepare to administer one ATNAA.

(a) Remove one ATNAA from your protective mask carrier, from the pocket of the MOPP suit, or from another location as specified by your unit SOP.

(b) Remove the autoinjector from the pouch.

(c) With your dominant hand, hold the ATNAA in your closed fist with the green needle end extending beyond the little finger in front of you at eye level.

(d) With your nondominant hand, grasp the safety (gray) cap with the thumb and first two fingers.

**CAUTION**

Do not cover or hold the needle end with your hand, thumb, or fingers. You may accidentally inject yourself.

(e) Pull the safety cap off the bottom of the injector with a smooth motion and drop it to the ground.

(f) With the nondominant hand, check the injection site in order to avoid buttons and objects in pockets where injecting. For injections into the thigh, grasp the trouser cargo pocket and pull forward, clearing possible obstructions from the site.

(g) Hold the ATNAA in your closed fist with the green needle end pointing out by your little finger.

(h) Place the needle end of the injector against the outer thigh muscle.

**Note.** Very thin soldiers should give the injection in the upper outer part of the buttocks.

**CAUTION**

When injecting antidote in the buttocks, be very careful to inject only into the upper, outer quarter of the buttocks to avoid hitting the major nerve that crosses the buttocks. Hitting the nerve may cause paralysis.

**Note.** The injection can be given in any part of the lateral thigh muscle from about a hand's width above the knee to a hand's width below the hip joint.

(2) Administer the injection.

(a) Push the injector into the muscle with firm, even pressure until it functions.

**Note.** A jabbing motion is not necessary to trigger the activating mechanism.

---

---

**Performance Steps**

---

(b) Hold the injector firmly in place for at least 10 seconds.

(c) Remove the injector from your muscle.

4. Secure the used injectors.

a. Drop the plastic clip (MARK I) without dropping the used injectors.

b. Use a hard surface to bend each needle to form a hook without tearing protective gloves or clothing.

c. Push the needle of each used injector (one at a time) through one of the pocket flaps of the protective overgarment.

5. Decontaminate skin if necessary.

**Note.** Information on this step is provided in Task 031-503-1013.

6. Put on remaining protective clothing.

**Note.** Information on this step is covered in Task 031-503-1015.

<p style="text-align: center;"><b>WARNING</b></p> <p>If, within 5 to 10 minutes after administering the first set of injections, your heart begins beating rapidly and your mouth becomes very dry, do not administer another set of injections.</p>
--

7. Seek buddy-aid or medical aid.

**Note.** After you have given yourself the first set of MARK I injections or one ATNAA, you most likely will not need additional antidote if you are ambulatory and know who and where you are. If needed, additional injections will be given only by a buddy, a combat lifesaver, or medical personnel.

8. Identify severe signs and symptoms of nerve agent poisoning.

a. Strange and confused behavior.

b. Gurgling sounds made when breathing.

c. Severely pinpointed pupils.

d. Red eyes with tearing.

e. Vomiting.

f. Severe muscular twitching.

g. Loss of bladder and/or bowel control.

h. Convulsions.

i. Unconsciousness or stoppage of breathing.

**Note.** If the casualty is exhibiting severe symptoms, assistance (buddy-aid) is required by the individual to complete first aid treatment.

9. Mask the casualty if necessary.

---

---

**Performance Steps**

---

**WARNING**

Do not kneel at any time while providing aid to the casualty. Contact with the ground could force the chemical into or through the protective clothing.

**Note.** Reposition the casualty on his back, if necessary, to mask the individual.

- a. Place the mask on the casualty.
  - b. If the casualty can follow directions, have him clear the mask.
  - c. Check for a complete mask seal by covering the inlet valves of the mask.
  - d. Pull the protective hood over the head, neck, and shoulders of the casualty.
  - e. Position the casualty on the right side, similar to a swimmer position, with the head slanted down so the casualty will not roll back over.
- 10.** Administer first aid to a nerve agent casualty (buddy-aid).
- a. MARK I.
    - (1)** Prepare to administer one atropine injection.
      - (a)** Position yourself near the casualty's thigh.
      - (b)** Remove all three sets of autoinjectors and the single CANA autoinjector from the casualty's mask carrier, BDU pocket, or from another location as specified by your unit SOP. Place the autoinjectors and CANA on the casualty's side. DO NOT place the unused devices on the ground.
      - (c)** With one hand, hold the set of injectors by the plastic clip with the big injector on top.
      - (d)** With the other hand, check the injection site to avoid buttons and objects in pockets. For injections into the thigh, grasp the trouser cargo pocket and pull forward (toward you), clearing possible obstructions from the site.
      - (e)** Grasp the small injector and pull it out of the clip with a smooth motion.
      - (f)** Hold the injector in your closed fist with the green needle end pointing out by your little finger without covering the needle end.
      - (g)** Place the needle end of the injector against the casualty's outer (lateral) thigh muscle.
-

---

**Performance Steps**

---

**Note.** The injection can be given in any part of the lateral thigh muscle from about a hand's width above the knee to a hand's width below the hip joint.

**Note.** Very thin soldiers should be given the injections in the upper outer part of the buttocks.

**WARNING**

When injecting antidote in the buttocks, be very careful to inject only into the upper, outer quarter of the buttocks to avoid hitting the major nerve that crosses the buttocks. Hitting the nerve may cause paralysis.

(2) Administer the atropine injection.

(a) Push the injector into the muscle with firm, even pressure until it functions.

(b) Hold the injector in place for at least 10 seconds.

(c) Remove the injector from the muscle and carefully place the used injector between two fingers of the hand holding the clip.

(3) Prepare to administer one 2 PAM CI injection.

(a) Pull the large injector out of the clip and hold the injector in your closed fist with the black needle end pointing out by your little finger without covering the needle end.

(b) Place the needle (black) end of the injector against the injection site.

(4) Administer the 2 PAM CI injection.

(a) Push the injector into the muscle with firm, even pressure until it functions.

(b) Hold the injector in place for at least 10 seconds.

(c) Drop the clip without dropping injectors.

(d) Lay the used injectors on the casualty's side.

**Note.** Repeat steps 10a (1) through 10a (4) until the casualty has received a total (including self-administered) of three sets of antidote injections.

**b. ATNAA**

(1) Prepare to administer one ATNAA.

(a) Obtain three or all remaining ATNAAs and one CANA from the casualty's protective mask carrier, from the pocket of the MOPP suit, or from another location as specified by your unit SOP.

(b) Remove one ATNAA from the pouch.

---

---

**Performance Steps**

---

(c) With your dominant hand, hold the ATNAA in your closed fist with the green needle end pointing out by your little finger, in front of you at eye level.

(d) With your nondominant hand, grasp the safety (gray) cap with the thumb and first two fingers.

**CAUTION**

Do not cover or hold the needle end with your hand, thumb, or fingers. You may accidentally inject yourself.

(e) Pull the safety cap off the bottom of the injector with a smooth motion and drop it to the ground.

(f) With the nondominant hand, check the injection site in order to avoid buttons and objects in pockets where injecting. For injections into the thigh, grasp the trouser cargo pocket and pull forward, clearing possible obstructions from the site.

(g) Hold the ATNAA in your closed fist.

(h) Place the needle end of the injector against the outer thigh muscle.

**Note.** The injection may be given in any part of the lateral thigh muscle from about a hand's width above the knee to a hand's width below the hip joint.

**Note.** Very thin soldiers should be given the injection in the upper outer part of the buttocks.

**CAUTION**

When injecting antidote in the buttocks, be very careful to inject only into the upper, outer quarter of the buttocks to avoid hitting the major nerve that crosses the buttocks. Hitting the nerve may cause paralysis.

(2) Administer the injection.

(a) Push the injector into the muscle with firm, even pressure until it functions.

**Note.** A jabbing motion is not necessary to trigger the activating mechanism.

(b) Hold the injector firmly in place for at least 10 seconds.

(c) Remove the injector from the muscle.

(d) Place the used injector on the casualty's side.

(3) Repeat the procedure for a total of three ATNAAs.

11. Administer the anticonvulsant, CANA.

a. Prepare to administer the CANA injection.

(1) Tear open the protective plastic packet and remove the injector.

---

---

**Performance Steps**

---

(2) With your dominant hand, hold the injector in your closed fist with the black needle end pointing out by your little finger.

(3) With the other hand, pull the safety cap off the injector base to arm the injector.

**CAUTION**

Do not touch the black (needle) end. You could accidentally inject yourself.

(4) Place the black end of the injector against the casualty's injection site.

b. Administer the CANA injection.

(1) Push the injector into the muscle with firm, even pressure until it functions.

(2) Hold the injector in place for at least 10 seconds.

12. Secure the used injectors.

a. Using a hard surface bend each needle to form a hook without tearing protective gloves or clothing.

b. Push the needle of each used injector (one at a time) through one of the pocket flaps of the casualty's protective overgarment.

13. Decontaminate the casualty's skin, if necessary.

**Note.** This information is covered in Task 031-503-1013.

14. Seek medical aid.

---

**Evaluation Preparation:**

*Setup:* You must use nerve agent antidote injection training aids to train and evaluate this task. Actual autoinjectors will not be used. For self-aid, have the soldier dress in MOPP 2. Have the soldier wear a mask carrier containing a mask and the training nerve agent autoinjectors. For buddy-aid, have the soldier being tested and the casualty dress in MOPP 2. Have the casualty lie on the ground wearing the mask carrier containing a mask and the training nerve agent autoinjectors.

*Brief Soldier:* For step 1, tell the soldier to state, in any order the mild symptoms of nerve agent poisoning. The soldier must state seven of the eight symptoms to be scored GO. Then, tell the soldier that he has mild symptoms and to take appropriate action. After the soldier completes step 4, ask what should be done next. Then ask what he should do after putting on all protective clothing. Score steps 5 through 7 based on the soldier's responses. For step 8, tell the soldier to state, in any order, the severe symptoms of nerve agent poisoning. The soldier must state eight of the nine symptoms to be scored GO. Tell the soldier to treat the casualty for nerve

agent poisoning. After the soldier completes step 11, ask what else he should do. Score steps 12 and 13 based on the soldier's responses.

Performance Measures	GO	NO GO
1. Identified mild signs of nerve agent poisoning.	___	___
2. Reacted to the chemical hazard.	___	___
3. Correctly administered the nerve agent antidote to self.	___	___
4. Secured the used injectors.	___	___
5. Decontaminated skin, if necessary.	___	___
6. Donned remaining protective clothing.	___	___
7. Sought help (buddy-aid).	___	___
8. Identified severe signs of nerve agent poisoning.	___	___
9. Masked the casualty.	___	___
10. Correctly administered nerve agent antidote to the casualty.	___	___
11. Secured the used injectors.	___	___
12. Decontaminated the casualty's skin if necessary.	___	___
13. Sought medical aid.	___	___
14. Performed steps 1 through 12 in the correct sequence.	___	___

**Evaluation Guidance:** Score the soldier GO if all the performance measures are passed. Score the soldier NO GO if any of the performance is failed. If the soldier scores NO GO, show what was done wrong and how to do it correctly.

**References**

**Required**

**Related**

- DVC 08-36
- DVC 08-37
- FM 4-25.11
- FM 8-285



---

## 081-831-1045

### Perform First Aid for Cold Injuries

**Conditions:** You see a casualty who has signs and symptoms of a cold injury. Necessary equipment and materials: canteen of potable water, blanket or similar item to use for warmth, and dry clothing.

**Standards:** Identified the type of cold injury and gave the correct first aid.

---

#### Performance Steps

---

**Note.** When performing first aid on a casualty, seek medical aid as soon as possible. Do not stop the first aid; but, if the situation allows, send another person to find medical aid.

1. Identify the type of cold injury.

a. Chilblain/frostnip. If the signs and symptoms are as follows, go to step 2a.

(1) Prolonged exposure of bare skin at temperatures of 60 degrees Fahrenheit to 32 degrees Fahrenheit.

(2) Redness or pallor of affected areas.

(3) Absence of pain (numb).

(4) May have ulcerated bleeding skin lesions.

**Note.** Freezing of superficial skin tissue may occur with frostnip; however, there is no freezing of the deeper tissues.

b. Frostbite. If the signs and symptoms are as follows, go to step 2b.

(1) Superficial.

(a) Loss of sensation or numb feeling in any part of the body.

(b) Sudden whitening of the skin in the affected area followed by a momentary tingling feeling.

(c) Redness of skin in light-skinned soldiers, grayish coloring in dark-skinned soldiers.

(2) Deep.

(a) Blisters.

(b) Swelling or tender areas.

(c) Loss of previous feeling of pain in the affected area.

(d) Pale, yellowish, waxy-looking skin.

(e) Frozen area feels solid or wooden to the touch.

---

---

**Performance Steps**

---

**c.** Immersion foot/trench foot. If the signs and symptoms are as follows, go to step 2c.

**(1)** Long exposure of feet to wet conditions at temperatures from 50 degrees Fahrenheit to 32 degrees Fahrenheit.

**(2)** Early stage/first phase.

**(a)** Affected area feels cold.

**(b)** Numb and painless.

**(3)** Later stage/advanced phase.

**(a)** Limbs feel hot and burning.

**(b)** Shooting pains.

**(c)** Affected area is pale with bluish cast.

**(d)** Pulse strength decreased.

**(e)** Other signs that may follow include blisters, swelling, redness, heat, hemorrhages, or gangrene.

**d.** Snow blindness. If the signs and symptoms are as follows, go to step 2d.

**(1)** Scratchy feeling in eyes, as if from sand or dirt.

**(2)** Watery eyes.

**(3)** Redness.

**(4)** Headache.

**(5)** Increased pain with exposure to light.

**e.** Hypothermia. If the signs and symptoms are as follows, go to step 2e.

**(1)** Mild hypothermia (body temperature 90 to 95 degrees Fahrenheit).

**Note.** This condition should be suspected in any chronically ill person who is found in an environment of less than 50 degrees Fahrenheit.

**CAUTION**

With generalized hypothermia, the entire body has cooled with the core temperature below 95 degrees Fahrenheit. (Temperature is provided as a guide; the common soldier probably would not have a thermometer to use.) This is a medical emergency.

**(a)** Conscious, but usually apathetic or lethargic.

**(b)** Shivering.

**(c)** Pale cold skin.

**(d)** Slurred speech.

---

---

**Performance Steps**

---

- (e) Poor muscle coordination.
- (f) Faint pulse.
- (2) Severe hypothermia (body temperature 90 degrees Fahrenheit or lower).
  - (a) Breathing slow and shallow.
  - (b) Irregular heart action.
  - (c) Pulse weaker or absent.
  - (d) Stupor or unconsciousness.
  - (e) Ice cold skin.
  - (f) Rigid muscles.
  - (g) Glassy eyed.

**CAUTION**

Hypothermia is a medical emergency. Prompt medical treatment is necessary. Casualty should be evacuated to medical treatment facility immediately.

f. Dehydration (cold weather). If the signs and symptoms are as follows, go to step 2f.

- (1) Mouth, tongue, and throat are parched and dry.
- (2) Swallowing is difficult.
- (3) Nausea and dizziness.
- (4) Fainting.
- (5) Tired and weak.
- (6) Muscle cramps especially in the legs.
- (7) Focusing eyes may be difficult.

2. Perform first aid for the cold injury.

a. Chilblain/frostnip.

- (1) Apply rewarming (body heat).
  - (a) Apply warmth with casualty's bare hands.
  - (b) Blow warm air on the affected area.
  - (c) For hands and fingertips, place hands in armpits.
- (2) Protect lesions (if present) with dry sterile dressing.
- (3) Seek medical aid.

**CAUTION**

Do not rub or massage area.

**Note.** If the condition does not respond to simple care, begin first aid for frostbite.

---

---

**Performance Steps**

---

**b. Frostbite.**

<b>CAUTION</b>
<b>DO NOT—</b> Rub snow on the frostbitten part. Massage or rub the frostbitten part. Use dry or radiant heat to rewarm. Rupture blisters. Use ointments or other medications on the part. Handle a frostbitten extremity roughly. Allow a thawed extremity to refreeze. Allow the casualty to use alcohol or tobacco products.

- (1) Warm the area using firm, steady pressure of hands, underarm, or abdomen.
- (2) Face, ears, nose—cover with hands (casualty's or a buddy's).
- (3) Hands—open casualty's field jacket and place against the body (under armpits if possible), then close the jacket.
- (4) Feet—remove boots, socks, and place feet under clothing and against the body of another soldier.

<b>CAUTION</b>
Do not remove clothing in a chemical environment.

<b>WARNING</b>
Do not attempt to thaw the casualty's feet, or other seriously frozen areas, if the soldier will be required to walk or travel to a medical center to receive medical treatment. The possibility of injury from walking is less when the feet are frozen than after they have been thawed (if possible, avoid walking). Thawing in the field increases the possibility of infection, gangrene, or injury.

- (5) Loosen or remove constricting clothing and remove any jewelry.
- (6) Increase insulation (cover with blanket or something similar and dry).
- (7) Have the casualty exercise as much as possible, avoiding trauma to injured part(s).
- (8) Seek medical aid. (Evacuate the casualty.)

<b>WARNING</b>
Monitor the casualty for life-threatening conditions and apply appropriate first aid as necessary.

**c. Immersion foot/trench foot.**

---

---

**Performance Steps**

---

- (1) Gradually rewarm by exposing to warm air.
  - (2) Protect affected parts from trauma.
  - (3) Dry feet thoroughly and avoid walking.
  - (4) Elevate the affected part.
  - (5) Seek medical treatment. (Evacuate the casualty.)
- d. Snow blindness.
- (1) Cover the eyes with a dark cloth.
  - (2) Seek medical treatment. (Evacuate the casualty.)
- e. Hypothermia.

**CAUTION**

This is a medical emergency! Prompt medical treatment is necessary.

- (1) Mild.
  - (a) Rewarm body evenly. (Must provide heat source--campfire or other soldier's body.)

**Note.** Merely placing the casualty in a sleeping bag or covering with a blanket is not enough since the casualty is unable to generate his own body heat.

- (b) Keep dry and protect from the elements.
  - (c) Give warm liquids gradually if the casualty is conscious.
  - (d) Seek medical treatment immediately.
- (2) Severe.
  - (a) Stabilize the temperature.
  - (b) Attempt to avoid further heat loss.
  - (c) Evacuate to the nearest medical treatment facility as soon as possible.

**Note.** Rewarming a severely hypothermic casualty in the field is extremely dangerous. There is a great possibility of complications such as rewarming shock and disturbance in the rhythm of the heartbeat.

**WARNING**

Monitor the casualty for life-threatening conditions.

- f. Dehydration.
- (1) Keep warm.
  - (2) Loosen clothes to improve circulation.
  - (3) Give fluids for fluid replacement.
-

---

**Performance Steps**

---

**Note.** Medical personnel will determine the need for salt replacement.

(4) Rest.

(5) Seek medical assistance.

---

**Evaluation Preparation:**

**Setup:** Have a soldier play the part of the cold injury casualty. Select one type of cold injury on which to evaluate the soldier. Coach the simulated casualty on how to answer questions about symptoms. Physical signs and symptoms that the casualty cannot readily simulate (for example blisters) must be described to the soldier.

**Brief Soldier:** Tell the soldier to determine what cold injury the casualty has. After the cold injury has been identified, ask the soldier to describe the proper treatment.

Performance Measures	GO	NO GO
1. Identified the type of cold injury.	___	___
2. Provided the proper first aid for the cold injury.	___	___

**Evaluation Guidance:** Score the soldier GO if all the performance measures are passed. Score the soldier NO GO if any performance measure is failed. If the soldier scores NO GO, show what was done wrong and how to do it correctly.

**References**

**Required**

**Related**

FM 4-25.11

---

**081-831-1046****Transport a Casualty**

**Conditions:** You have evaluated and given first aid to a casualty. You need to move the casualty to get further medical aid. There may or may not be other soldiers to help. Necessary equipment and materials: two pistol belts or rifle slings or improvised material that will not cut or bind the casualty (cravat bandages or litter straps), poncho, shirts or jackets, and poles or tree limbs.

**Standards:** Transported the casualty using an appropriate carry without dropping or causing further injury to the casualty.

---

**Performance Steps**

---

1. Select an appropriate carry for the casualty.

**Warning**

Do not use manual carries to move a casualty with a neck or spine injury, unless a life-threatening hazard is in the immediate area. Seek medical personnel for guidance on how to move and transport the casualty.

- a. Fireman's carry. Use for an unconscious or severely injured casualty.
- b. Support carry. Use for a casualty who is able to walk or hop on one leg.
- c. Arms carry. Use for short distances only, for a casualty who is unable to walk.
- d. Saddleback carry. Use for a conscious casualty only.
- e. Pack-strap carry. Use for carrying a casualty moderate distances.
- f. Pistol-belt carry. Use for long distances. This carry allows the hands of the casualty and bearer to be free.
- g. Pistol-belt drag. Use in combat, generally for short distances.
- h. Neck drag. Use in combat, generally for short distances.

**CAUTION**

Do not use the neck drag if the casualty has a broken arm or a suspected neck injury.

- i. Cradle-drop drag. Use to move a casualty who cannot walk when being moved up or down stairs.
  - j. Two-man support carry. Use for both conscious and unconscious casualties.
  - k. Two-man arms carry. Use for moderate distances and for placing a casualty on a litter.
- Note.** In extreme emergencies, the two-man arms carry is the safest for transporting a casualty with a back or neck injury. If possible, use two more bearers to keep the casualty's head and legs in alignment with his body.
- l. Two-man fore-and-aft carry. Use for long distances and for placing a casualty on a litter.
  - m. Two-hand seat carry. Use for carrying a casualty short distances and for placing him on a litter.
-

---

**Performance Steps**

---

n. Four-hand seat carry. Use for moderate distances for a casualty who is conscious and can stand but not walk. Can be used to place a casualty on a litter and is especially useful in transporting a casualty with a head or foot injury.

o. Use litters if materials are available, if the casualty must be moved a long distance, or if manual carries will cause further injury.

2. Perform the carry.

a. Fireman's carry.

(1) Kneel at the casualty's uninjured side.

(2) Place casualty's arms above the head.

(3) Cross the ankle on the injured side over the opposite ankle.

(4) Place one of your hands on the shoulder farther from you and your other hand on his hip or thigh.

(5) Roll the casualty toward you onto his abdomen.

(6) Straddle the casualty.

(7) Place your hands under the casualty's chest and lock them together.

(8) Lift the casualty to his knees as you move backward.

(9) Continue to move backward, thus straightening the casualty's legs and locking the knees.

(10) Walk forward, bringing the casualty to a standing position but tilted slightly backward to prevent the knees from buckling.

(11) Maintain constant support of the casualty with one arm. Free your other arm, quickly grasp his wrist, and raise the arm high.

(12) Instantly pass your head under the casualty's raised arm, releasing it as you pass under it.

(13) Move swiftly to face the casualty.

(14) Secure your arms around his waist.

(15) Immediately place your foot between his feet and spread them (approximately 6 to 8 inches apart).

(16) Again grasp the casualty's wrist and raise the arm high above your head.

(17) Bend down and pull the casualty's arm over and down your shoulder bringing his body across your shoulders. At the same time pass your arm between the legs.

(18) Grasp the casualty's wrist with one hand while placing your other hand on your knee for support.

---



---

**Performance Steps**

---

(19) Rise with the casualty correctly positioned.

**Note.** Your other hand is free for use as needed.

**b.** Support carry.

(1) Raise the casualty to a standing position as in the fireman's carry.

(2) Grasp the casualty's wrist and draw his arm around your neck.

(3) Place your arm around his waist.

**Note.** The casualty is thus able to walk using you as a crutch.

**c.** Arms carry.

(1) Raise the casualty to a standing position as in the fireman's carry.

(2) Place one arm under the casualty's knees and your other arm around his back.

(3) Lift the casualty carrying him high to lessen fatigue.

**d.** Saddleback carry.

(1) Raise the casualty to a standing position as in the fireman's carry.

(2) Support the casualty by placing an arm around his waist.

(3) Move in front with your back to him.

(4) Have the casualty encircle your neck with his arms.

(5) As you stoop, raise the casualty upon your back.

(6) Clasp your hands together beneath his thighs if possible.

**e.** Pack-strap carry.

**Note.** In this carry the casualty's weight rests high on the bearer's back. To eliminate the possibility of injury to the casualty's arms, the bearer must hold the casualty's arms in a palms-down position.

(1) Raise the casualty to a standing position as in the fireman's carry.

(2) Supporting the casualty with your arms around him, grasp the wrist closer to you.

(3) Place the arm over your head and across your shoulder.

(4) Move in front of the casualty while supporting his weight against your back.

(5) Grasp the other wrist.

(6) Place this arm over your shoulder.

---

---

**Performance Steps**

---

(7) Bending forward, hoist the casualty as high on your back as possible so all his weight is resting on your back.

f. Pistol-belt carry.

(1) Link two pistol belts (or three, if necessary) together to form a sling.

**Note.** If pistol belts are not available for use, other items, such as one rifle sling, two cravat bandages, two litter straps, or any suitable material that will not cut or bind the casualty may be used.

(2) Place the sling under the casualty's thighs and lower back so a loop extends from each side.

(3) Lie face up between the casualty's outstretched legs.

(4) Thrust your arms through the loops.

(5) Grasp the hand and trouser leg on the casualty's injured side.

(6) Roll toward the casualty's uninjured side onto your abdomen, bringing him onto your back.

(7) Adjust the sling as necessary.

(8) Rise to a kneeling position.

**Note.** The belt will hold the casualty in place.

(9) Placing one hand on your knee for support, rise to an upright position.

**Note.** The casualty is now supported on your shoulders.

(10) Carry the casualty with your hands free for use in rifle firing, climbing banks, or surmounting obstacles.

g. Pistol-belt drag.

(1) Extend two pistol belts (or three, if necessary) or similar objects to their full length and join them together to make one loop.

(2) Roll the casualty onto his back.

(3) Pass the loop over the casualty's head and position it across his chest and under the armpits.

(4) Cross the remaining portion of the loop forming a figure eight.

**Note.** Keep tension on the belts so they do not become unhooked.

(5) Lie on your side facing the casualty, resting on your elbow.

(6) Slip the loop over your arm and shoulder on which you are leaning.

(7) Turn away from the casualty onto your abdomen so you can drag the casualty as you crawl.

---

---

**Performance Steps**

---

**h. Neck drag.****WARNING**

Do not use the neck drag if the casualty has a broken and/or fractured arm or a suspected neck injury. If the casualty is unconscious, protect his head from the ground.

(1) Tie the casualty's hands together at the wrists. (If conscious, the casualty may clasp his hands together around your neck.)

(2) Straddle the casualty in a kneeling face-to-face position.

(3) Loop the casualty's tied hands over and/or around your neck.

(4) Crawl forward, looking ahead, dragging the casualty with you.

**i. Cradle drop drag.**

(1) With the casualty lying on his back, kneel at the head.

(2) Slide your hands, palms up, under the casualty's shoulders.

(3) Get a firm hold under his armpits.

(4) Partially rise, supporting the casualty's head on one of your forearms.

**Note.** You may bring your elbows together and let the casualty's head rest on both of your forearms.

(5) With the casualty in a semi-sitting position, rise and drag the casualty backwards.

(6) Back down the steps (or up if appropriate), supporting the casualty's head and body and letting the hips and legs drop from step to step.

**j. Two-man support carry.**

(1) Two bearers help the casualty to his feet and support him with their arms around his waist.

(2) The bearers grasp the casualty's wrists and draw his arms around their necks.

**k. Two-man arms carry.**

**Note.** In extreme emergencies, when there is no time to obtain a board, this carry is the safest for transporting a casualty with a back and/or neck injury. Use two additional bearers to keep the head and legs in alignment with the body.

(1) Two bearers kneel at one side of the casualty and place their arms beneath the casualty's back (shoulders), waist, hips, and knees.

---

---

**Performance Steps**

---

(2) The bearers lift the casualty as they rise to their knees. Keep the casualty's body level to prevent unnecessary movement and further injury.

(3) As the bearers rise to their feet, they turn the casualty toward their chests. To lessen fatigue, bearers should carry the casualty high and as close to their chests as possible.

**l.** Two-man fore-and-aft carry.

(1) Position the casualty on his back, if necessary.

(2) The taller of the bearers kneels at the casualty's head.

(3) The shorter bearer spreads the casualty's legs and kneels between the legs with his back to the casualty.

(4) The shorter bearer positions his hands behind the casualty's knees.

(5) The taller bearer kneels at the casualty's head, slides his hands under the casualty's arms and across the chest, and locks his (bearer's) hands together.

(6) The bearers rise together while lifting the casualty.

**Note.** The alternate method, with both bearers facing the casualty, is useful for placing the casualty on a litter.

**m.** Two-hand seat carry.

(1) Position the casualty on his back, if necessary.

(2) A bearer kneels on each side of the casualty at the hips.

(3) Each bearer passes his arms under the casualty's thighs and back, and grasps the other bearer's wrists.

(4) The bearers rise while lifting the casualty.

**n.** Four-hand seat carry.

(1) Each bearer grasps one of his own wrists and one of the other bearer's wrists to form a packsaddle.

(2) The bearers lower themselves sufficiently for the casualty to sit on the packsaddle.

(3) The casualty places his arms around the bearers' shoulders for support.

(4) The bearers rise to an upright position.

**o.** Improvised litter.

(1) Use the poncho and two poles or limbs.

---

---

**Performance Steps**

---

- (a) Open the poncho and lay the two poles lengthwise across the center forming three equal sections.
- (b) Reach in and pull the hood up toward you and lay it flat on the poncho.
- (c) Fold one section of the poncho over the first pole.
- (d) Fold the remaining section of the poncho over the second pole to the first pole.
- (2) Use shirts or jackets and two poles or limbs.
  - (a) Button two or three shirts or jackets and turn them inside out leaving the sleeves inside.
  - (b) Lay the shirts or jackets on the ground and pass the poles through the sleeves.
- (3) Place the casualty on the litter by using any of the following carries:
  - (a) One-man arms carry.
  - (b) Two-man arms carry.
  - (c) Two-man fore-and-aft carry.
  - (d) Two-hand seat carry.
  - (e) Four-hand seat carry.
- (4) Lift the litter.
  - (a) Raise the litter together.
  - (b) Keep the litter as level as possible.

**Note.** Use caution when transporting on a slope, incline, and/or hill.

---

**Evaluation Preparation:**

*Setup:* For the one-man carries, you will need another soldier to play the part of the casualty and for the two-man carries, two soldiers will be needed. In the two-man carry, one soldier will be the casualty and the other will help the soldier who is being tested. Tell the casualty what the injuries are and whether he is conscious or unconscious. Obtain appropriate materials (strip of cloth, pistol belts, poles, branches, poncho, blanket, etc.) as necessary, to test the carries.

*Brief Soldier:* Tell the soldier that the casualty has been given first aid. Describe a situation in terms of the casualty's injuries, whether the casualty is conscious or unconscious, whether enemy fire can be expected or not, and what distance (short, moderate, or long) the casualty must be moved. Tell the soldier to transport the casualty using an appropriate carry.

**Note:** Do not make the situation too complex and remember, when scoring the soldier, that two or more of the carries might be appropriate for the situation. The most important thing is that the selected carry should not cause further injury to the casualty and should not endanger the lives of the two soldiers.

Performance Measures	GO	NO GO
1. Selected the appropriate method of transporting the casualty.	___	___
2. Performed the carry.	___	___
3. Did not cause further unnecessary injury.	___	___

**Evaluation Guidance:** Score the soldier GO if all performance measures are passed. Score the soldier NO GO if any performance measure is failed. If the soldier scores NO GO, show what was done wrong and how to do it correctly.

**References**

**Required**

**Related**

FM 4-25.11

---

**081-831-1053**

**Practice Individual Preventive Medicine Countermeasures**

**Conditions:** You are a soldier deployed to a unit in the field. Necessary equipment and materials will vary depending on physical environment and climate: water, food, uniforms, replacement clothing, barrier creams and lotions, standard military skin extended-duration repellent lotion, permethrin aerosol clothing repellent, d-phenothrin aerosol area spray, malaria pills, soap, mosquito bednet, iodine tablets, canteen, covered container, plastic bags, earplugs, foot powder, talcum powder, razor, toothbrush, dental floss, and an entrenching tool.

**Standards:** Applied preventive medicine countermeasures to protect, as appropriate, against cold, heat, biting insects, diarrhea and dysentery, hearing loss, skin infections, sexually transmitted diseases (STD), acquired immunodeficiency syndrome (AIDS), and foot problems. Practiced oral hygiene, proper disposal of waste, and Army tobacco use rules.

---

**Performance Steps**

1. Apply proper preventive medicine measures (PMMs) for protection against cold injuries.
    - a. Wear layers of loose clothing.
- 

3-110

081-831-1053

---

**Performance Steps**

---

**Note.** Minimize sweating. When clothing becomes wet or dirty, it loses its ability to provide warmth.

- (1) Remove layers of clothing before doing strenuous work.

**WARNING**

Do not remove protective clothing in a chemical environment.

- (2) Replace layers of clothing when your strenuous work is completed.

- (3) Launder clothing regularly.

**b.** Exercise to increase blood circulation.

- (1) Tighten and relax arm and leg muscles, fingers, and toes.

- (2) Use hands to massage and warm the face.

- (3) Refrain from smoking because it restricts blood flow to the skin.

**WARNING**

Physical and mental weariness contribute to inactivity, reduced heat, and increased chance for cold injury.

**c.** Change socks.

- (1) Put on dry socks during rest breaks to reduce the risk of frostbite and trench foot.

**WARNING**

Severe frostbite and trench foot can result in the loss of hands or feet.

- (2) Put damp socks inside the shirt to dry.

**d.** Prevent dehydration.

- (1) Drink sufficient fluids (potable water, juices, and warm nonalcoholic beverages).

**Note.** Drinking a sufficient amount of potable water in cold weather is as important as it is in hot weather. In cold weather, you may not realize that your body is losing fluids and salt. Sweat evaporates rapidly or is absorbed so completely by the layers of clothing that it is seldom visible on the skin.

- (2) Rest when possible.

**e.** Pair with a buddy.

- (1) Remind each other to do warming exercises often.

- (2) Watch for signs of cold injury such as frostbite, trench foot, and hypothermia.
-

---

**Performance Steps**

---

2. Apply proper PMMs for protection against heat injuries.

a. Drink sufficient amounts of water.

**Note.** Your body needs a minimum amount of water for cooling, waste elimination, and metabolism. Any attempt to train the body to use less water can be harmful and may lead to heat injuries.

(1) Hourly fluid intake should not exceed 1 ½ quarts of water every hour. Daily fluid intake should not exceed 12 quarts. If your urine is dark yellow, you are not drinking enough water.

(2) Fluid intake needs will vary depending on type of work and temperature (see table 081-831-1053-1 and figure 081-831-1053-1).

---



**Performance Steps**

<b>Table 081-831-1053-1. *Fluid Replacement Policy for Warm Weather *(Average acclimated soldier wearing BDU, Hot Weather)</b>							
<i>Heat Category</i>	<i>WBGT Index °F</i>	<i>Easy Work</i>		<i>Moderate Work</i>		<i>Hard Work</i>	
		<i>Work/ Rest</i>	<i>Water intake Qt/hr</i>	<i>Work Rest</i>	<i>Water Intake, Qt/hr</i>	<i>Work Rest</i>	<i>Water Intake, Qt/hr</i>
1*	78 – 81.9	NL	½	NL	¾	40/20 min	¾
2 (green)	82 – 84.9	NL	½	50/10 min	¾	30/30 min	1
3 (yellow)	85 – 87.9	NL	¾	40/20 min	¾	30/30 min	1
4 (red)	88 – 89.9	NL	¾	30/30 min	¾	20/40 min	1
5** (black)	>90	50/10 min	1	20/40 min	1	10/50 min	1

**Caution**

Hourly fluid intake should not exceed 1 ½ quarts. Daily fluid intake should not exceed 12 quarts.

\*Work/rest times and fluid replacement volumes will sustain performance and hydration for at least 4 hours of work in the specified heat category. Individual water needs will vary ± ¼ quarts per hour.

\*NL = no limit to work time per hour. Rest means minimal physical activity (sitting or standing) and should be accomplished in shade if possible.

Wearing body armor adds 5 degrees Fahrenheit to WBGT Index.

\*Wearing all MOPP overgarments adds 10 degrees Fahrenheit to WBGT Index.

\*\*Suspend physical training and strenuous activity. If an operational (nontraining) mission requires strenuous activity, enforce water intake to minimize expected heat injuries.

---

**Performance Steps**

---

<b>*Examples of Categories of Work</b>		
<i>Easy Work</i>	<i>Moderate Work</i>	<i>Hard Work</i>
Weapon maintenance Walking on hard surface at 2.5 mph, ≤ 30-lb load. Manual of arms. Marksmanship training. Drill and ceremony.	Walking on loose sand at 2.5 mph, no load. Walking on hard surface at 3.5 mph, < 40-lb load. Calisthenics Patrolling. Individual movement techniques, such as low crawl, high crawl. Defensive position construction. Field assaults.	Walking on loose sand at 2.5 mph with load. Walking on hard surface at 3.5 mph, ≥ 40-lb load.

**Figure 081-831-1053-1. Examples of work categories**

- (3) Drink extra water before combat operations.
  - (4) Maintain excess water in your system for strength and alertness.
  - (5) Protect yourself from dehydration and heat injuries associated with wearing full chemical protective gear.
    - b. Rest whenever possible.
      - (1) Take rest breaks in accordance with the heat condition table as the tactical situation permits.
      - (2) Use rest breaks to drink water and to cool off.
    - c. Eat meals.
      - (1) Eat regular meals daily to replace salt lost through heavy sweating.
      - (2) Eat something at each meal, even if you are not hungry.
  - Note.** Usually, eating field rations or liberal salting of the garrison diet will provide enough salt. Excess intake of salt should be avoided.
    - d. Protect yourself from exposure.
      - (1) Wear uniform properly.
      - (2) Provide shade whenever possible.
      - (3) Use barrier creams and lotions.
  - 3. Apply proper PMMs for protection against arthropod (insect) bites and arthropod-borne diseases.
    - a. Apply extended-duration arthropod repellent lotion.
-

---

**Performance Steps**

---

**Note.** Extended-duration arthropod repellent lotion can be used on the skin.

- (1) Apply lotion on exposed skin except the eyes, lips, and sensitive skin.
- (2) Spread lotion two inches under edges of battle dress uniform (BDU).
- (3) Keep the lotion away from flame or excessive heat.
- (4) Wipe hands after application.

**Note.** Do not wear after-shave lotion or cologne in the field; they attract biting or stinging arthropods (insects).

**b.** Apply permethrin clothing repellent. Use either the IDAA kit (most effective) or the aerosol formulation.

- (1) Apply permethrin according to the product label.
- (2) Use only on fabric.
- (3) Do not apply to skin.
- (4) Do not treat BDUs while being worn.
- (5) Treat outside of BDU, insect headnet, and mosquito bednet.
- (6) Do not treat underwear or inside the cap.
- (7) Avoid breathing vapors.
- (8) Dry clothing (BDUs) thoroughly prior to wearing.

**c.** Wear uniform properly.

- (1) Tuck pant legs into boots, roll sleeves down, and close collar.
- (2) Wear uniform loosely.
- (3) Check clothing frequently.
- (4) Use buddy system to check areas of body not easily seen during self-examination.

**d.** Take malaria pills to protect against malaria parasites. (Use in the manner prescribed for your unit.)

**e.** Clean and inspect yourself. Wash yourself daily or as often as the tactical situation permits.

**f.** Clean and inspect your clothing.

- (1) Wash your uniform to remove arthropods and their eggs.
- (2) Use available military laundry service or scrub your clothing and yourself with soap and water.

**g.** Use your bednet when sleeping.

- (1) Suspend bednet above sleeping area.
-

---

**Performance Steps**

---

- (2) Tuck edges of bednet under the sleeping pad or bag.
- (3) Treat the bednet with permethrin aerosol clothing repellent.
- (4) Spray interior space with d-phenothrin aerosol spray insecticide.
- (5) Avoid breathing vapors.
- (6) Do not use permethrin clothing repellent or d-phenothrin aerosol spray insecticide on skin.

4. Apply proper PMMs for protection against water-borne and food-borne diseases.

a. Identify the indications of diarrhea and dysentery.

(1) Diarrhea is an intestinal disorder characterized by abnormally frequent and watery bowel movements.

(2) Dysentery is an infectious disease characterized by stomach pain and diarrhea with passage of mucus and blood.

b. Purify your drinking water if treated water is not available.

**Note.** Before using iodine tablets, check them for physical change. If they are old, they can lose their disinfecting ability. Tablets that are not uniformly steel gray or that are stuck together or crumbled should not be used.

(1) Fill your canteen with the cleanest, clearest water available.

(2) Add iodine tablets.

(a) Add two tablets to a one-quart canteen of water.

(b) Double the amount of tablets if a two-quart canteen is

used.

(3) Replace the cap.

(4) Wait five minutes for the tablets to dissolve.

(5) Shake the canteen to mix the contents.

(6) Disinfect the canteen cap threads.

(a) Loosen the cap.

(b) Tip the canteen over and squeeze to allow leakage around the canteen threads.

(c) Turn the canteen right side up.

(d) Tighten the cap.

(7) Wait 30 additional minutes before drinking.

c. Obtain food and drink from an approved source.

(1) Obtain food, drink, and ice only from medically approved sources.

---

---

**Performance Steps**

---

**Note.** Do not obtain food, drink, and ice from vendors unless medical personnel have approved them.

- (2) Obtain food from the dining facility when possible.
- d. Wash your hands for at least 30 seconds—
  - (1) After using the latrine.
  - (2) Before touching eating utensils or food.
  - (3) After eating.
  - (4) After smoking.
- e. Dispose of food waste properly.
  - (1) Place it in a covered container to keep pests out and to prevent breeding of flies.
  - (2) Use plastic bags if you have dumpster-type receptacles and regular waste pick-up.
  - (3) Bury waste if you are in the field and do not have waste pick-up or other disposal methods available.

**Note.** Before burying any waste, obtain prior approval by contacting either the logistics or the preventive medicine section.

- 5. Apply proper PMMs for protection against hearing loss.
    - a. Wear protective devices such as earplugs, ear canal caps, or earmuffs.
    - b. Wear vehicle headgear such as helicopter crew helmets and armored vehicle crew helmets.
    - c. Keep hearing protection devices clean to avoid ear infections.
    - d. Avoid noise and/or limit the time in noise hazardous areas.
  - 6. Apply proper PMMs to prevent skin infections.
    - a. Bathe frequently. Take a full bath at least once every week. If showers or baths are not available, use a washcloth daily to wash.
      - (1) Genital area.
      - (2) Armpits.
      - (3) Feet.
      - (4) Other areas where you sweat or which become wet (between thighs or, for females, under breasts).
    - b. Keep skin dry.
      - (1) Use foot powder on your feet (especially if you have had fungal infections in the past).
-

---

**Performance Steps**

---

(2) Use talcum powder in areas where wetness is a problem.  
(Cornstarch may be used as a substitute for talcum powder.)

c. Change to clean clothing after a full bath.

(1) Wear loose-fitting uniforms to allow for better ventilation and blood circulation.

(2) Wear proper clothing.

**Note.** Do not wear nylon or silk-type undergarments. Cotton undergarments allow more evaporation of moisture.

d. Shave facial hair often enough to be clean shaven (males only) to allow a tight fit of the protective mask.

7. Apply proper PMMs for care of the feet.

a. Before movement.

(1) Wear the proper type of footgear correctly fitted and broken in.

(2) Wear clean socks free of holes or knotty darns.

(3) Use foot powder.

(4) Treat and protect blisters, pressure spots, and infections before movement.

b. During movement.

(1) Keep feet as dry as possible.

(2) Change socks (if possible) for dry ones when they become damp or wet.

(3) Dry socks by putting them under your shirt around your waist.

(4) Relieve tender pressure spots on the feet by adjusting gear.

(5) Dust the feet with foot powder once or twice daily.

c. Inspect feet at rest periods.

(1) Wash feet during the noon break if possible.

(2) Raise feet while resting to help reduce congestion and swelling.

d. Take care of blisters.

(1) Wash the blister and the surrounding area with soap and water.

(2) Seek medical treatment for painful blisters or signs of infection such as redness, throbbing, and drainage.

8. Practice good oral hygiene.

a. Brush your teeth after every meal if possible.

b. Use dental floss at least once a day.

c. Rinse your mouth with potable water after brushing and flossing.

---

---

**Performance Steps**

---

**9. Protect against sexually transmitted diseases (STDs).**

- a.** Use a condom (rubber).

**Note.** Individuals should use a condom during vaginal, anal, or oral sex when there is a possibility of acquiring an infection.

- b.** Avoid high-risk sexual behaviors.

- (1)** Having more than one sexual partner.
- (2)** Changing sex partners frequently.
- (3)** Having sex with casual partners, prostitutes, or their clients.
- (4)** Sexual practices such as anal sex.

- c.** Control alcohol intake (it affects your ability to use safe sex practices).

**10. Protect against human immunodeficiency virus (HIV), the virus that causes AIDS.**

**Note.** HIV is contagious in the same way STDs are contagious. Infection can result from a sexual relationship with an infected person. Sexual contact is not the only way to contract HIV but is a major contributor.

**a.** Prevent sexual transmission—know your partner. Avoid having sex with persons who might be infected with HIV. At highest risk are those who have more than one sex partner, or who have unprotected sex with casual partners, prostitutes or their clients, partners who are HIV infected, or who share needles with others,

**b.** Prevent transmission through shared needles or syringes—do not use injected, nonprescribed drugs.

**Note.** There is presently no cure for AIDS and no vaccine to prevent HIV infection.

**11. Apply proper PMMs for disposal of waste.**

- a.** For human waste—

- (1)** Use unit latrine.
- (2)** Use cat-hole latrine.
  - (a)** Use only on the march.
  - (b)** Cover immediately after use.
- (3)** Use a straddle trench for 1-3 day bivouac.

- b.** For other waste—

- (1)** Bury—less than one week in the field.
- (2)** Incinerate —longer than one week in the field.

**12. Apply the Army's tobacco use policies.**

---

---

**Performance Steps**

---

- a. Effects of tobacco use.
    - (1) Long term health costs.
    - (2) Diseases/conditions related to tobacco use.
    - (3) Effects on health of nonsmokers.
    - (4) Use of smokeless tobacco.
  - b. Effects on soldiers' performance and health.
    - (1) Increases number of sick call visits.
    - (2) Decreases readiness.
    - (3) Decreases night vision.
    - (4) Decreases hand-eye coordination.
    - (5) Decreases stamina.
    - (6) Increases cold weather injuries.
    - (7) Increases overall number of injuries.
    - (8) Leads to addiction.
  - c. Army tobacco policies in accordance with AR 600-63.
  - d. Available resources for tobacco use cessation.
- 

**Evaluation Preparation:**

*Setup:* Evaluate this task during a field training exercise (FTX) or during a normal training session. If the evaluation is conducted during an FTX, the environmental and physical conditions at the FTX will be used as the scenario for which preventive medicine countermeasures are implemented. If the evaluation is done during a normal training session, create the scenario to include environmental and physical conditions.

*Brief Soldier:* Tell the soldier he will be evaluated on his ability to apply the appropriate preventive medicine countermeasures. The soldier will respond to appropriate performance measures.

Performance Measures	GO	NO GO
1. Protected against cold.	___	___
2. Protected against heat.	___	___
3. Protected against arthropod bites and arthropod-borne diseases.	___	___
4. Protected against water-borne and food-borne diseases.	___	___
5. Protected against hearing loss.	___	___



Performance Measures	GO	NO GO
6. Prevented skin infections.	___	___
7. Provided care for the feet.	___	___
8. Practiced good oral hygiene.	___	___
9. Protected against sexually transmitted diseases.	___	___
10. Protected against AIDS.	___	___
11. Disposed of waste properly.	___	___
12. Identified the Army's policies of tobacco use.	___	___

**Evaluation Guidance:** Score the soldier GO if all performance measures are passed. Score the soldier NO GO if any performance measure is failed. If the soldier scores NO GO, show what was done wrong and how to do it correctly.

**References**

**Required**

**Related**

- AR 600-63
- FM 21-10
- FM 4-25.11

**SUBJECT AREA 3: NUCLEAR, BIOLOGICAL, AND CHEMICAL (NBC)**

**031-503-1013**

**Decontaminate Yourself and Individual Equipment Using Chemical Decontaminating Kits**

**Conditions:** You are at mission-oriented protective posture (MOPP) 2 given the assigned protective mask, protective gloves, a full canteen of water, a poncho, load-bearing equipment (LBE), assigned decontaminating kit(s), and applicable technical manuals (TMs). Your skin is contaminated or has been exposed to chemical agents, or you have passed through a chemically contaminated area.

**Standards:** Decontaminate yourself and your individual equipment using chemical decontaminating kits. Start the steps to decontaminate your skin and eyes within 1 minute after you found they were contaminated.

Decontaminate all exposed skin and your eyes as necessary before chemical agent symptoms occur. Decontaminate all personal equipment for liquid contamination after decontaminating your skin, face, and eyes.

---

**Performance Steps**

---

1. Assume MOPP3.
2. Decontaminate your skin using the M291 decontaminating kit according to TM 3-4230-229-10.

**CAUTION**

The M291 decontaminating kit is for external use only. Keep decontaminating powder out of your eyes, cuts, and wounds. The decontaminating powder may slightly irritate your skin or eyes. Use water to wash the toxic agent out of your eyes, cuts, or wounds.

**DANGER**

**Death or injury may result if you breathe toxic agents while decontaminating your face. If you need to breathe before you finish, reseal your mask, clear it, check it, get your breath, and then resume the decontaminating procedure.**

**Note.** After decontamination with water, cover exposed cuts or wounds with appropriate first aid wrap or bandages before handling the decontaminating package.

**CAUTION**

Keep the decontaminating powder out of your eyes, cuts, and wounds. Do not handle or hold leaking packets above your head, touch or rub your eyes with anything that has been in contact with the decontaminating powder, or touch your lips or the inside of your mouth with anything that has been in contact with the decontaminating powder.

**CAUTION**

Do not attempt to decontaminate a loaded weapon. Always unload, clear, and place weapons on safe before starting decontaminating procedures.

**CAUTION**

Immediate decontaminating techniques remove only the liquid hazard. Certain items may still present a vapor hazard. See your supervisor for unmasking procedures.

- a. Decontaminate your hands, your face, and the inside of your mask.
  - b. Assume MOPP4.
-

---

### Performance Steps

---

- c. Remove the decontaminating powder with soap and water when operational conditions permit.
- 3. Decontaminate your individual equipment using the M295 decontaminating kit according to TM 3-4230-235-10.
  - a. Use the first mitt to decontaminate your gloves, the exposed areas of your mask and hood, your weapon, and your helmet.
  - b. Use the second mitt to decontaminate your LBE and accessories, your mask carrier, your overboots, and your gloves again.
  - c. Remove the decontaminating powder when operational conditions permit.
- 4. Dispose of hazardous waste materials.
  - a. Dispose of uncontaminated hazardous waste materials.
    - (1) Dispose of expended or unserviceable materials according to federal, state, and local laws; military regulations and publications; host nation laws (if more restrictive than United States [U.S.] laws); and local standing operating procedures (SOPs).
    - (2) Place used decontaminating materials in a sealed plastic bag, and label it with the contents (as a minimum). Give the bag to your supervisor.
  - b. Dispose of contaminated hazardous waste materials. Inform your supervisor of the status of contaminated hazardous waste.

---

### Evaluation Preparation:

*Setup:* A good time to evaluate this task is while in a field environment. Gather materials for disposal of hazardous waste according to federal, state, and local rules and regulations.

*Brief Soldier:* Tell the soldier what body parts and equipment are contaminated.

Performance Measures	GO	NO GO
1. Assumed MOPP3.	___	___
2. Decontaminated his skin using the M291 decontaminating kit.	___	___
3. Decontaminated his individual equipment using the M295 decontaminating kit.	___	___
4. Disposed of hazardous waste materials. Complied with all federal, state, and local laws and regulations.	___	___

**Evaluation Guidance:** Score the soldier GO if all performance measures are passed. Score the soldier NO GO if any performance measure is failed. If the soldier fails any performance measure, show him what he did wrong and how to do it correctly.

#### References

Required	Related
FM 3-5	FM 3-4
TM 3-4230-229-10	
TM 3-4230-235-10	

---

### 031-503-1015

#### Protect Yourself from NBC Injury/Contamination with Mission-Oriented Protective Posture (MOPP) Gear

**Conditions:** You are given MOPP gear (chemical protective overgarment, mask, hood, overboots, protective gloves, individual decontamination kits, and antidotes), and one of the following situations in a chemically contaminated tactical environment:

1. You are ordered to achieve MOPP4.
2. You learn that a chemical attack is about to happen.
3. You must enter an area where chemical agents have been used.
4. You recognize a chemical hazard.
5. You are attacked with chemical agents without warning.

**Standards:** Protect yourself from nuclear, biological and chemical (NBC) injury or contamination with MOPP gear. Perform all steps in sequence and achieve MOPP4 within 8 minutes.

---

#### Performance Steps

1. Put on MOPP gear for MOPP1.
  - a. Don the trousers.
    - (1) Put on the overgarment trousers over your normal duty uniform or over your undergarments in hot weather.
    - (2) Secure the trousers by snapping and zipping them and adjusting the waistband for a snug fit.
    - (3) Do not fasten the bottom of the trousers at this time.
  - b. Don the jacket.
    - (1) Put on the overgarment jacket.

---

**Performance Steps**

---

(2) Zip it up.

(3) Fasten the snaps.

c. Secure the jacket to the trousers by snapping the three snaps across the back of the jacket to the trousers.

2. Put on additional MOPP gear (protective overboots) to reach MOPP2.

a. Put on the older model chemical protective overboots over your leather combat boots, lacing them according to the instructions provided in the package.

**Note.** The older model has a single eyelet at the rear.

(1) Don the cover on either foot by centering your foot on the sole.

(2) Smooth the excess material as flat as possible.

(3) Lace the overboots.

(a) Thread the lace through the front eyelet so the ends are the same length.

(b) Tie a single hitch by passing one lace end through each eyelet from the inside to the outside, drawing each lace end tight.

(c) Pass both ends through the rear eyelet from the inside to the outside.

(d) Bring the ends back through the side eyelets.

(e) Tighten the lace by working the slack out between the side and back eyelets.

**Note.** The lace should hold the rear eyelet firmly against the boot.

(4) Tie the lace tightly across the instep with a single hitch.

(5) Wrap the excess lace around your leg, tying the ends with a reef or bow knot.

b. Put on the newer model chemical protective overboots over your leather combat boots, lacing them according to the instructions provided in the package.

**Note.** The newer model has two rear eyelets.

(1) Don the cover on either foot by centering your foot on the sole.

(2) Tuck the excess front material under the front of your foot.

(3) Lace the overboots.

(a) Thread the lace through the front eyelet so both ends are the same length.

(b) Pass each lace end through a side eyelet from the inside to the outside.

---

---

**Performance Steps**

---

- (c) Draw the lace up tightly, fastening it with a single knot.
  - (d) Pass the ends through the rear eyelets from the inside to the outside.
  - (e) Pull the lace up firmly, positioning the fishtails neatly at the sides of your ankle.
  - (f) Tie the lace firmly with a single knot in front.
- (4) Wrap the loose lace ends around your leg, tying them firmly in front with a bow knot and tucking in the loose ends.
- c. Put on the green vinyl overboots over your leather combat boots, securing them by pulling the rubber bands around the metal buttons.
  - d. Blouse the overgarment trouser legs over the chemical protective overboots.
  - e. Secure the closures of the overgarment trouser legs by zipping and tying the drawstrings firmly.

**Note.** The newer model method is being taught at the U.S. Army Chemical School. Units that still have the older model should continue to use the older model donning instructions.

3. Put on the protective mask with hood to reach MOPP3.
- a. Don the protective mask.
  - b. Don the hood.
  - c. Zip the hood (M17-series protective mask only).
  - d. Adjust the neck cord.
  - e. Attach the underarm straps.

**Note.** The time standards for masking do not apply to this task.

4. Put on additional MOPP gear to reach MOPP4 within 8 minutes.
- a. Secure the MOPP gear by zipping all zippers and closing all closures.
  - b. Put on the chemical protective gloves (rubber gloves and liners).
  - c. Pull the elastic cuffs of the overgarment jacket sleeves over the cuffs of the chemical protective gloves.
-

---

**Performance Steps**

---

**Note.** After assuming MOPP4 and performing all the tasks according to the unit SOP, perform the following actions:

1. Use all means of NBC detection to check your surrounding area for the presence of contamination.
2. Contact higher headquarters (HQ) if no contamination is found or if you determine the attack was non-NBC.
3. Await further guidance. (Higher HQ contacts all adjacent/attached units to check the status of NBC contamination in their areas. If all units report the absence of contamination, the information is reported up the chain of command.)
4. Annotate the above actions on your duty log (Department of the Army [DA] Form 1594).

---

**Evaluation Preparation:**

*Setup:* Evaluate this task during a field exercise or during a normal training session. Gather all necessary MOPP gear and ensure that it is in good condition. Be ready to direct higher MOPP levels immediately as a soldier reaches a preceding level.

Performance Measures	GO	NO GO
1. Put on MOPP gear for MOPP1.	___	___
2. Put on additional MOPP gear to reach MOPP2.	___	___
3. Put on the protective mask with hood to reach MOPP3.	___	___
4. Put on additional MOPP gear to reach MOPP4 within 8 minutes.	___	___

**Evaluation Guidance:** Score the soldier GO if all performance measures are passed. Score the soldier NO GO if any performance measure is failed. If the soldier fails any performance measure, show him what was done wrong and how to do it correctly.

**References****Required**

DA Form 1594  
FM 3-4  
TM 3-4240-279-10  
TM 3-4240-280-10

**Related**

TM 3-4240-300-10-2

---

## 031-503-1017

### Respond to Depleted Uranium

**Conditions:** You are in a combat situation where DU munitions or weapon systems that may contain DU are in use or may be used, given a protective mask, gloves, first-aid supplies, Graphic Training Aid (GTA) 03-04-001A, and one of the following situations:

1. You encounter expended DU penetrators or parts of penetrators.
2. You encounter United States (U.S.) or foreign armored vehicles that have breached crew compartments.
3. You encounter a fire where DU munitions may be involved.

**Standards:** Respond to DU and implement protective measures as required.

---

#### Performance Steps

**Note.** The presence of DU will not prevent accomplishment of mission and will not be a concern when actively engaged in direct combat. The presence of DU can only be positively confirmed with AN/VDR2 or AN/PDR77 radiation, detection, indication, and computation (RADIAC) meters.

1. Administer first aid for DU injuries and treat wounds according to the soldier's manual of common tasks (SMCT) task 081-831-1044..
2. Identify DU hazard.
  - a. Recognize expended or damaged DU penetrators or parts of penetrators.
  - b. Recognize a breached armored vehicle crew compartment.
  - c. Recognize fires that involve DU munitions.

**Note.** There are no additional protective measures required for intact DU munitions beyond those standard for all munitions.

3. Protect yourself from contact with DU.
  - a. Leave all penetrators alone and notify the chain of command of their location.
  - b. Put on a protective mask and cover exposed skin (if required) to decontaminate the crew compartment of an armored vehicle that has been penetrated by an armor-piercing munition.
  - c. Remain 50 meters or more from any armored vehicle or ammunition transport vehicle that is actively burning.

**Note.** Standard field hygiene to include washing hands and face will help prevent the transfer and ingestion of DU. All munitions found on the battlefield should be considered potentially dangerous and left alone for removal by specially trained personnel.



---

**Performance Steps**

---

4. Report known or suspected DU contamination to the chain of command. Medical personnel will be notified when casualties are determined or suspected to have been exposed to DU.
- 

**Evaluation Preparation:**

*Setup:* Evaluate this task during a field exercise or during a normal training session. Establish a situation where contamination may occur either from the presence of spent DU penetrators on the ground, the breaching of the armored vehicle, or a fire where DU munitions are involved. If an armored vehicle is available, simulate a DU penetrator impact and damage by any means possible.

*Brief soldier:* Tell the soldier to identify the possible hazard and respond appropriately to the situation.

Performance Measures	GO	NO GO
1. Administered first aid for DU injuries and treated wounds according to the SMCT.	—	—
2. Identified DU hazard.	—	—
<b>Note.</b> The method used depends on the scenario.		
3. Protected himself from contact with DU.	—	—
a. Left all penetrators alone and notified the chain of command of their location..		
b. Put on protective mask and covered exposed skin (if required) to decontaminate the crew compartment of an armored vehicle that was penetrated by an armor-piercing munition.		
c. Remained 50 meters or more from any armored vehicle or ammunition transport vehicle that was actively burning.		
4. Reported known or suspected DU contamination to chain of command. Medical personnel were notified when casualties were determined or suspected to have been exposed to DU.	—	—

**Evaluation Guidance:** Score the soldier GO if all performance measures are passed. Score the soldier NO GO if any performance measure is failed. If the soldier scores NO GO, show what was done wrong and how to do it correctly.

---

## References

### Required

GTA 03-04-001A

### Related

TB 9-1300-278

---

## 031-503-1018

### React to Nuclear Hazard/Attack

**Conditions:** You are in a tactical situation or an area where nuclear weapons have been or may have been used and are given load-bearing equipment (LBE), a piece of cloth or similar item, a brush or a broom, shielding material, Field Manual (FM) 3-3-1, and one of the following situations to respond to:

1. You see a brilliant flash of light.
2. You find a standard radiological contamination marker or an enemy marker.
3. You are told that fallout is in the area.
4. You receive instructions to respond to a nuclear attack.
5. You come across a suspected depleted uranium (DU) hazard.

**Standards:** React to a nuclear hazard or attack without becoming a casualty of a nuclear attack with or without warning. Identify radiological contamination markers with 100 percent accuracy, and notify the supervisor. Start the steps to decontaminate yourself within 1 minute of finding radiological contamination. Decontaminate your individual equipment after you completely decontaminate yourself.

---

### Performance Steps

1. React to a nuclear attack without warning.
    - a. Close your eyes immediately.
    - b. Drop to the ground in a prone, head-on position.

**Note.** If you are in the hatch of an armored vehicle, immediately drop down inside the vehicle.

    - c. Keep your head and face down and your helmet on.
    - d. Stay down until the blast wave passes and debris stops falling.
    - e. Cover your mouth with a cloth or similar item to protect against inhalation of dust particles.
    - f. Check for casualties and damaged equipment.
  2. React to a nuclear attack with warning.
    - a. Select and use the best available shelter (FM 3-3-1).
-

---

**Performance Steps**

---

- (1) Move into a fighting position, bunker, or ditch.
  - (2) Take protective actions if you are inside a shelter.
  - (3) Remain in place if you are in an armored vehicle.
- b. Protect your eyes.
  - c. Minimize exposed skin areas.
  - d. Cover your mouth with a cloth or similar item to protect against inhalation of dust particles.
3. React to a radiological contamination marker.
  - a. Avoid the area if possible.
  - b. Cross the area quickly by the shortest route that exposes you to the least amount of radiation based on mission, enemy, terrain, troops, time available, and civilian considerations (METT-TC).
    - (1) Request crossing instructions if you must cross.
    - (2) Make the maximum use of shielding.
    - (3) Cover your mouth with a cloth or similar item to protect against inhalation of dust particles.
  - c. Report the discovery of a marker to your supervisor.
4. Remove radiological contamination (including DU) from clothing, equipment, and exposed skin.
  - a. Shake or brush contaminated dust (all dust is considered to be radioactive) from your clothing, equipment, and exposed skin with a brush, a broom, or your hands (if a brush or a broom is not available).
  - b. Wash your body as soon as possible, giving special attention to hairy areas and underneath your fingernails.
  - c. Conduct mission-oriented protective posture (MOPP) gear exchange if you are contaminated with wet radioactive contamination.

---

**Evaluation Preparation:**

*Setup:* Evaluate this task during a field exercise if possible. Select an area that provides several shelters that the soldier can choose from (an open area, a shallow ditch, a depression, or a foxhole with overhead cover). Evaluate the soldier's reaction to a nuclear attack without warning (brilliant flash of light) and with warning by having him stand in an open area with the nearest possible shelter no closer than 12 feet. You may simulate the attack by saying "BRILLIANT FLASH" or by using the flash attachment of a camera. Tell the soldier there will be a nuclear detonation within 2 minutes and to take the best available shelter. Evaluate the soldier's ability to react to radiological contamination markers by telling him to walk through the area (where a standard marker and a former Warsaw Pact marker have been

placed) and take appropriate action. Evaluate the soldier's ability to remove radiological contamination.

*Brief Soldier:* Tell the soldier that a nuclear attack is imminent and that he must react to a nuclear attack with and without warning. Tell him that he must also react to nuclear contamination markers. Tell the soldier that after being exposed to nuclear radiation, he must take the steps for decontamination.

Performance Measures	GO	NO GO
1. Reacted to a nuclear attack without warning.	___	___
2. Reacted to a nuclear attack with warning.	___	___
3. Reacted to a radiological contamination marker.	___	___
4. Removed radiological contamination (including DU) from clothing, equipment, and exposed skin.	___	___

**Evaluation Guidance:** Score the soldier GO if all performance measures are passed. Score the soldier NO GO if any performance measure is failed. If the soldier fails any performance measure, show him what was done wrong how to do it correctly.

#### References

**Required**  
FM 3-3-1

**Related**  
FM 3-5

---

## 031-503-1019

### React to Chemical or Biological Hazard/Attack

**Conditions:** You are given mission-oriented protective posture (MOPP) gear, a protective mask, individual decontaminating kits, and a tactical environment in which CB weapons have been or may be used by the enemy. You are in MOPP1, and one or more of the following automatic masking criteria happens:

1. A chemical alarm sounds.
2. A positive reading is obtained on detector paper.
3. Individuals exhibit symptoms of CB agent poisoning.
4. You observe a contamination marker.
5. Your supervisor tells you to mask.
6. You see personnel wearing protective masks.
7. You observe other signs of a possible CB attack.

**Standards:** React to a chemical or biological hazard or attack without becoming a casualty. Identify chemical contamination markers with 100 percent accuracy, and notify supervisor. Start steps to decontaminate yourself within 1 minute of finding chemical contamination. Decontaminate your individual equipment after you completely decontaminate yourself.

---

**Performance Steps**

---

1. Identify the CB hazard automatic masking criteria.
  - a. Don your protective mask when there is a high probability of a chemical attack, when--
    - (1) A chemical alarm sounds.
    - (2) A positive reading is obtained on detector paper.
    - (3) Individuals exhibit symptoms of CB agent poisoning.
    - (4) You observe a contamination marker.
    - (5) Your supervisor tells you to mask.
    - (6) You see personnel wearing protective masks.
    - (7) You observe other signs of a possible CB attack.
  - b. Respond to the commander's policy of automatic masking.

**Note.** Commanders at all levels may establish a modified policy when chemical weapons have been employed by designating additional events as automatic masking criteria.

2. Protect yourself from CB contamination using your assigned protective mask without fastening the hood.

**Note.** The mask gives immediate protection against inhalation of agent vapors. Do not fasten the hood. Go to the next step immediately.

3. Give the alarm.
    - a. Yell "GAS."
    - b. Give the appropriate hand-and-arm signal.
  4. Take cover to reduce exposure, using whatever means is readily available.
  5. Decontaminate exposed skin using the individual decontaminating kit, as necessary.
  6. Assume MOPP4. Cover all your skin (your head and shoulders are already protected by the mask and the overgarment).
    - a. Put on the gloves with liners.
    - b. Zip and fasten the overgarment jacket.
    - c. Secure the hood, then secure the overgarment to increase protection.
-

---

**Performance Steps**

---

**d. Put on the overboots.**

**Note.** Combat boots provide protection but should be covered because they absorb chemicals. It takes a long time to put on the overboots, so put them on last in an emergency.

**7.** Decontaminate personal equipment using the individual decontaminating kit as necessary.

**8.** Notify your supervisor of any CB hazard markers or indicators.

**9.** Continue the mission.

**Note.** After assuming MOPP4 and performing all the tasks according to the unit SOP perform the following actions:

1. Use all means of CB detection to check your surrounding area for the presence of contamination.
2. Contact higher headquarters (HQ) if no contamination is found or if you determine the attack was non-CB.
3. Await further guidance. (Higher HQ contacts all adjacent/attached units to check the status of CB contamination in their areas. If all units report the absence of contamination, the information is reported up the chain of command.)
4. Annotate the above actions on your duty log (Department of the Army [DA] Form 1594).

---

**Evaluation Preparation:**

**Setup:** A good time to evaluate this task is during a field exercise when a variety of CB hazards can be simulated. Select a site with adequate cover, and ensure that soldiers are in MOPP1.

**Brief Soldier:** Tell the soldier there will be an encounter with simulated CB contamination and/or a CB alarm will be given. The task is to recognize the hazard and/or alarm and to take appropriate action to protect himself and warn other soldiers by giving the appropriate alarm.

Performance Measures	GO	NO GO
1. Identified the CB hazard automatic masking criteria.	___	___
2. Protected himself from CB contamination using his assigned protective mask without fastening the hood..	___	___
3. Gave the alarm.	___	___
4. Took cover to reduce exposure, using whatever means was readily available.	___	___
5. Decontaminated exposed skin using the individual decontaminating kit as necessary.	___	___

Performance Measures	GO	NO GO
6. Assumed MOPP4. Covered all his skin.	___	___
7. Decontaminated personal equipment using the individual decontaminating kit as necessary.	___	___
8. Notified the supervisor of any CB hazard markers or indicators.	___	___
9. Continued the mission.	___	___

**Evaluation Guidance:** Score the soldier GO if all performance measures are passed. Score the soldier NO GO if any performance measure is failed. If the soldier fails any performance measure, show him what was done wrong how to do it correctly.

**References**

**Required**

DA Form 1594  
 FM 3-4  
 TM 3-4230-229-10  
 TM 3-4230-235-10

**Related**

FM 3-5

---

**031-503-1035**

**Protect Yourself from Chemical/Biological Contamination Using Your Assigned Protective Mask**

**Conditions:** You are given your assigned protective mask with hood and carrier, a canteen with an M1 canteen cap, an M291 skin decontamination kit, an M295 decontamination kit, M8 detector paper, and applicable technical manuals (TMs). You find yourself in one of the following situations:

1. You hear or see a chemical or biological (CB) attack.
2. You realize, through other means, that you are under a CB attack.
3. You are ordered to mask.
4. You must enter a contaminated area.

After having donned your protective mask, you need to drink from your canteen.

**Standards:** Protect yourself from chemical or biological contamination using your assigned protective mask. Don, clear, and check your mask within 9 seconds. Drink water through your protective mask from your canteen without becoming a casualty.

---

**Performance Steps**

---

1. Don the mask as quickly as possible.
  - a. Stop breathing and close your eyes.
  - b. Remove your helmet.
    - (1) If you have the M17-, M24-, M25-, M40-, M43-, or M45-series protective mask, put your helmet between your legs (above your knees) or hold your rifle between your legs and place your helmet on the muzzle. If you drop your helmet, continue to mask.
    - (2) If you have the M42-series protective mask, remove your helmet and place it in a convenient location. Avoid placing it on a contaminated surface if possible.

**WARNING**

Do not wear contact lenses with the protective mask. Remove contact lenses when the use of chemical agents is imminent.

- c. Take off your glasses if applicable.
      - d. Open the mask carrier with one hand.
      - e. Grasp the mask assembly with your other hand, and remove it from the carrier.
      - f. Put your chin in the chin pocket, and press the facepiece snugly against your face.
    - Note.** The temple and forehead straps have already been adjusted during fitting.
    - g. Grasp the tab and pull the head harness over your head. Ensure that your ears are between the temple straps and the cheek straps. Ensure that the head harness is pulled far enough over so the forehead straps are tight.
    - h. Use one hand to tighten the cheek straps, one at a time, while holding the head pad centered on the back of your head with the other hand. Ensure that the straps lay flat against your head.
  2. Clear the mask.
    - a. Seal the outlet valve by pushing in on the center of the outlet valve cover with one hand.
    - b. Blow out hard to ensure that any contaminated air is forced out around the edges of the facepiece.
  3. Check the mask.
    - a. Cover the inlet port of the filter canister (M40- and M45-series) or the inlet port of the armor quick disconnect (M42-series) with the palm of your hand, and breathe in.
-



---

**Performance Steps**

---

- b.** Ensure that the facepiece collapses against your face and remains so while you hold your breath (indicates that the mask is airtight).
  - c.** Remove any hair, clothing, or other matter between your face and the mask if the facepiece does not collapse to your face.
  - d.** Notify your nuclear, biological, and chemical (NBC) noncommissioned officer (NCO) in charge if it still does not collapse.
- 4.** Complete steps 1 through 3 within 9 seconds.
- 5.** Resume breathing.
- Note.** There are no time standards for donning the hood.
- 6.** Secure the mask hood.

**CAUTION**

Be careful when pulling on the hood, because it could snag on the buckles of the head harness and tear.

- a.** If you have the M17-, M25-, M42-, or M43-series protective mask, pull the hood over your head and zip the front closed to cover all bare skin.
  - b.** If you have the M24- or M45-series protective mask, pull the M7 hood over your helmet and head so that it covers your shoulders.
  - c.** If you have the M40-series protective mask, don the hood so it lies smoothly on your head.
    - (1)** For masks equipped with the regular hood--
      - (a)** Grasp the back edge of the hood skirt.
      - (b)** Pull the hood completely over your head so it covers the back of your head, neck, and shoulders.
      - (c)** Zip the front of the hood closed by pulling the zipper slider downward.
      - (d)** Tighten the drawcord.
      - (e)** Secure the underarm straps by fastening and adjusting them.
-

---

**Performance Steps**

---

**(f)** Put on your helmet. If you have a combat vehicle crewman (CVC) helmet—

- 1** Disconnect the boom microphone from the helmet.
- 2** Connect the mask microphone to the receptacle in the helmet.
- 3** Grasp the helmet next to the ear cups, with your hand spread as far as possible.
- 4** Place the helmet over your head, tilting the helmet forward slightly so the first contact when putting it on is with the forehead surface of the mask.
- 5** Rotate the helmet back and down over your head until it is seated in position.

**(g)** Close your mask carrier.

**(h)** Continue your mission.

**(2)** For masks equipped with the quick-doff hood—

**(a)** Place your hands inside the hood, and expand the elastic gathering around the neck of the hood.

**(b)** Stretch and carefully pull the hood over your head so the hood covers your head, neck, and shoulders.

**(c)** Fasten and adjust the underarm straps.

**(d)** Put on the helmet. If you have the CVC helmet—

- 1** Disconnect the boom microphone from the helmet.
- 2** Connect the mask microphone to the receptacle in the helmet.
- 3** Grasp the helmet next to the ear cups, with your hand spread as far as possible.
- 4** Place the helmet over your head, tilting the helmet forward slightly so the first contact when putting it on is with the forehead surface of the mask.
- 5** Rotate the helmet back and down over your head until it is seated in position.

**(e)** Close your mask carrier.

**(f)** Continue your mission.

---

---

**Performance Steps**

---

**WARNING**

Do not connect the quick-disconnect coupling half to your canteen until all surfaces are free of contamination. Chemical contamination could enter your mouth, resulting in you becoming a casualty.

**WARNING**

Do not break the mask seal while drinking from the canteen.

7. Drink water while wearing the mask. (Does not apply to M17- or M24-series masks.)

a. Press in on the top of the outlet valve cover until the internal drink tube can be grasped between your teeth.

b. Steady the mask assembly, and pull the quick-disconnect coupling out of the outlet valve cover.

c. Flip open the cover on the M1 canteen cap.

d. Push the quick-disconnect coupling into the canteen cap so that the pin enters the quick-disconnect coupling.

**WARNING**

If resistance is not felt, your drinking system is leaking. Do not drink. Replace your canteen. If resistance is still not felt, notify your NBC noncommissioned officer (NCO).

e. Blow to create positive pressure. You should feel some resistance.

**Note.** Do not tilt your head back while drinking.

f. Raise the canteen upside down, and drink if the system does not leak.

g. Stop drinking after several swallows, and lower the canteen. Blow into the internal drink tube to prevent the canteen from collapsing. Repeat the drinking procedure as required.

h. Disconnect the drinking system according to the appropriate TM.

8. Remove and store the mask according to the appropriate TM.

9. Perform all steps in sequence without becoming a casualty.

---

**Evaluation Preparation:**

*Setup:* Evaluate this task during a field exercise or a tactical training session. Use a mask previously fitted to the soldier's face. The soldier will bring his flight or CVC helmet. The soldier should be in MOPP4. Do not use a new decontamination kit for every soldier; use the kit as long as possible.

Ensure that the soldier has M8 detector paper in the mask carrier before testing. If the soldier has not made adequate progress towards drinking from the canteen after 2 minutes, stop him and give him a NO GO. This time standard is administrative.

*Brief Soldier:* Tell the soldier to stand while wearing his mask carrier containing his assigned protective mask with hood attached. If applicable, tell him to remove his eyeglasses and/or contact lenses before starting the evaluation. Provide the soldier with one of the scenarios described in the conditions statement (cue to begin masking). Tell him to keep the mask on until you issue the all-clear order. Tell the soldier that all time standards are for administrative (noncombat) evaluation purposes only. Tell him to drink water while wearing his assigned mask. Tell him that there are no time standards for this task; but for testing purposes, he should be able to drink within 2 minutes.

Performance Measures	GO	NO GO
1. Donned the mask as quickly as possible.	___	___
2. Cleared the mask.	___	___
3. Checked the mask.	___	___
4. Completed steps 1 through 3 within 9 seconds.	___	___
5. Resumed breathing.	___	___
6. Secured the mask hood.	___	___
7. Drank water while wearing the mask.	___	___
8. Removed and stored the mask.	___	___
9. Performed all steps in sequence without becoming a casualty.	___	___

**Evaluation Guidance:** Score the soldier GO if all performance measures are passed. Score the soldier NO GO if any performance measure is failed. If the soldier fails any performance measure, show what was done wrong and how to do it correctly.

**References**

**Required**

FM 3-3

FM 3-4

TM 3-4240-279-10

**Related**

3-140

031-503-1035

## References

### Required

TM 3-4240-280-10

TM 3-4240-346-10

### Related

---

## 031-503-1036

### Maintain Your Assigned Protective Mask

**Conditions:** You have used your assigned protective mask or must conduct a scheduled mask inspection. You are given your assigned protective mask (with authorized accessories and components); a container of warm, soapy water; soap; a container of warm, clear water; cheese cloth or clean rags; a small cleaning brush; alcohol; optical lens cleaning compound (national stock number [NSN] 6850-00-592-3283); the applicable technical manual (TM); Department of the Army (DA) Form 2404; spare parts for the masks; and a set of replacement filters (M17-series mask) or a replacement canister. This task cannot be performed in mission-oriented protective posture (MOPP) 4.

**Standards:** Maintain your assigned protective mask. Perform preventive-maintenance checks and services (PMCS) on the mask according to the applicable TM. Clean and dry the mask. Do not damage the mask. Record uncorrected deficiencies and shortcomings on DA Form 2404, and report them to the supervisor.

---

**Performance Steps**

---

**WARNING**

Do not attempt to remove the hose from the facepiece on the M42 protective mask. This may cause leakage of toxic agents into the facepiece.

**CAUTION**

Do not dunk the mask or the carrier in water. Wash the mask carefully so the canister and the microphone do not get wet. Keep water away from the inlet valve connections

**CAUTION**

Ensure that all components are entirely dry before reassembling the mask and storing it.

**Note.** Each soldier, under the supervision of a qualified 54B (chemical operations specialist) or another trained person, must care for and maintain his protective mask.

1. Conduct operator PMCS on the protective mask, the carrier, the hood, and the accessories according to the applicable TM.
  - a. Identify deficiencies and shortcomings.
  - b. Correct operator deficiencies.
  - c. Record all uncorrected deficiencies and shortcomings on DA Form 2404, and report them to the supervisor.
2. Clean and dry the mask, the hood, and the authorized accessories and components according to the applicable TM.
3. Replace defective components and parts according to the applicable TM. Replace damaged and outdated filter elements or canisters according to the applicable supply bulletin.
4. Store the mask, the hood, and the accessories in the carrier according to the applicable TM.
5. Perform steps 1 through 4 without damaging the mask.

---

**Evaluation Preparation:**

*Setup:* A good time to evaluate this task is during normal care and cleaning of the mask. Place the required equipment on a field table or another suitable surface. Simulate defects in the mask by removing components from the mask or using a defective mask not issued to the soldier. During training and evaluation sessions, use an old set of filters or canister several times to avoid expending new ones each time. If the soldier has not made adequate progress completing the task within 30 minutes, stop him and give him a NO GO. This time standard is administrative.

**Brief Soldier:** Tell the soldier there is no time standard for this task on the job; but for testing purposes he must perform the task within 30 minutes. Tell him to perform operator PMCS on the mask, to clean and condition his assigned protective mask, and to replace the filters in the mask. Tell the soldier that completing a DA Form 2404 is not part of the task.

Performance Measures	GO	NO GO
1. Conducted operator PMCS on the protective mask, the carrier, the hood, and the accessories according to the applicable TM.	—	—
2. Cleaned and dried the mask, the hood, and the authorized accessories and components according to the applicable TM.	—	—
3. Replaced defective components and parts according to the applicable TM. Replaced damaged and outdated filter elements or canisters according to the applicable supply bulletin.	—	—
4. Stored the mask, the hood, and the accessories in the carrier according to the applicable TM.	—	—
5. Performed steps 1 through 4 without damaging the mask.	—	—

**Evaluation Guidance:** Score the soldier GO if all performance measure are passed. Score the soldier NO GO if any performance measure is failed. If the soldier fails any performance measure, show him what was done wrong and how to do it correctly.

#### References

##### Required

DA Form 2404  
 TM 3-4240-279-10  
 TM 3-4240-280-10

##### Related

---

## 031-503-1037

### Detect Chemical Agents Using M8 or M9 Detector Paper

**Conditions:** You are in a tactical environment or an area where there is a chemical threat and are in mission-oriented protective posture (MOPP) 2. You are given a protective mask, a booklet of M8 detector paper, a dispenser of M9 detector paper, an M256A1 chemical agent detector kit,

assigned decontaminating kits (M291 or M295), and a complete set of MOPP gear or a chemical protective ensemble.

**Standards:** Detect chemical agents using M8 or M9 detector paper. Attach the M9 detector paper in places likely to come into contact with liquid chemical agents. Detect all liquid chemical agents in the area without becoming a casualty. Identify all liquid chemical agents within the capability of the M8 detector paper.

---

#### Performance Steps

---

1. Use the M9 detector paper.

**Note.** M9 and M8 detector paper will not detect chemical agent vapors.

a. Attach the M9 detector paper to your MOPP gear and equipment while wearing chemical protective gloves.

(1) Place the M9 detector paper on the MOPP gear, on opposite sides of your body.

(a) If you are right-handed, place a strip of M9 detector paper around your right upper arm, left wrist, and right ankle.

**Note.** These are the places where a moving soldier will most likely brush against a surface (such as undergrowth) that is contaminated with a liquid chemical agent.

(b) If you are left-handed, place a strip of M9 detector paper around your left upper arm, right wrist, and left ankle.

**Note.** Do not attach M9 detector paper to hot, dirty, oily, or greasy surfaces because it may give a false positive reading.

(2) Place M9 detector paper on the equipment where it will come in contact with contaminated objects and is visible to the operator.

b. Monitor the M9 detector paper constantly for any color change. If you observe a color change—mask, give the alarm, decontaminate as necessary, and assume MOPP4.

#### WARNING

Some decontaminants give false positive results on the M8 detector paper. The M8 detector paper may indicate positive results if used in an area where decontaminants have been used.

2. Use M8 detector paper if you see a liquid that might be a chemical agent or if you observe a color change on the M9 detector paper.

a. Prepare M8 detector paper. Tear out a sheet from the book (use one-half sheet if it is perforated).

**Note.** You may want to put the paper on the end of a stick or another object then blot the paper on the suspected liquid agent.

---



---

### Performance Steps

---

- b. Blot (do not rub) the M8 detector paper on the suspected liquid agent without touching the liquid with your protective glove.
- c. Observe the M8 detector paper for a color change. Identify the contamination by comparing any color change on the M8 detector paper to the color chart on the inside front cover of the booklet:
  - (1) A yellow-gold color indicates the presence of G (nerve) agent.
  - (2) A red-pink color indicates the presence of H (blister) agent.
  - (3) A dark green color indicates the presence of V (nerve) agent.
  - (4) If any other color is present or if there is no color change, the liquid cannot be identified using M8 detector paper.
- d. Store the booklet of M8 detector paper.
- e. Remain in MOPP4 even if the liquid cannot be identified. Use other types of chemical agent detectors to verify test results.
- f. Notify your supervisor of the test results.

**Note.** M8 detector paper reacts positive to petroleum products, ammonia, and decontaminating solution #2 (DS2). M9 detector paper reacts positive to petroleum products, insecticides, and antifreeze. Because M9 detector paper only detects but does not identify chemical agents, verify all readings with M8 detector paper. If you observe a color change on M8 or M9 detector paper, assume it is a liquid chemical agent. Confirm the presence of contamination by using all means of chemical agent detection available in your area of operation, including a visual check of your surroundings. If you determine that your reading is a false positive, perform the following actions before giving the all-clear signal:

1. Ensure that every attempt has been made to recheck the area.
2. Contact your higher headquarters (HQ) or the person in charge, and report the negative results.
3. Await further guidance. (Higher HQ contacts all adjacent/attached units to check the status of contamination in their areas. If all units report the absence of contamination, the information is reported up the chain of command.)
4. Annotate the above actions on your duty log (Department of the Army [DA] Form 1594).

---

### Evaluation Preparation:

**CAUTION**

Ensure that a simulant is placed only on the detector paper, not on the protective clothing.

*Setup:* Simulate an unknown liquid chemical agent by using expedient training aids (brake fluid, cleaning compound, gasoline, insect repellent, or antifreeze). Place drops of the simulated agent on M9 detector paper to obtain a reading. For M8 detector paper, place the simulated agent on a nonporous material (such as an entrenching tool).

*Brief Soldier:* Tell the soldier that he will be entering an area where chemical agents have been used. Tell him to attach M9 detector paper to his MOPP gear and equipment. Tell him that if you observe any unsafe acts or acts that could produce a false reading, you will stop the test and he will be scored NO GO.

Performance Measures	GO	NO GO
1. Used M9 detector paper.	___	___
2. Used M8 detector paper if he saw a liquid that might have been a chemical agent or if he observed a color change on the M9 detector paper.	___	___

**Evaluation Guidance:** Score the soldier GO if all performance measures are passed. Score the soldier NO GO if any performance measure is failed. If the soldier fails any performance measure show him what was done wrong and how to do it correctly.

#### References

##### Required

DA Form 1594  
 FM 3-3  
 FM 3-4  
 TM 3-6665-307-10  
 TM 3-6665-311-10

##### Related

### SUBJECT AREA 4: SURVIVE [COMBAT TECHNIQUES]

## 052-192-1042

### Perform Self-Extraction from a Mined Area

**Conditions:** You are in an area containing buried mines and trip wire-activated mines, given a probing device, a trip wire feeler, personal protective equipment, marking material, and a vehicle.

**Note:** A mine detector is not available.

**Standards:** Self-extract from a mined area, by foot or from a vehicle, under the following conditions without causing personal injury or mine detonation. When footprints are clearly visible, when footprints are not clearly visible (stepping-stone and lane technique), and from a vehicle. Locate, mark, and bypass each trip wire and mine within the area probed. Remove enough soil to confirm the presence of a mine. Report the mined area information to higher headquarters.

3-146

052-192-1042

---

### Performance Steps

---

1. Take immediate action on observed indicators or confirmation of a mine.

**Note:** The acronym for stop, assess, note, draw back, inform (SANDI) is used to remember the sequence of events for extraction. *Stop* and gain control of yourself. *Assess* the situation of mines or booby traps and personnel. *Note* the situation for future reference. *Draw back* to the last known safe area. Self-extraction to the nearest safe area may be referred to as draw back. *Inform* higher headquarters of the situation. The letters from the acronym will be reinforced throughout this task and represented with bold letters.

- a. **Stop** immediately and gain control of yourself.

- (1) Do not move your feet if you are on foot.

- (2) Remain in the vehicle.

- (3) Warn other elements operating in the area, and advise higher elements of the situation for possible support with extraction.

**Note** In an emergency mine situation involving a single casualty, call for help. If the casualty is conscious, establish communication with the victim. Instruct the soldier to remain still and administer self-help first aid. Reassure him that help is coming. The use of radio communications equipment is acceptable. While there are certain mines that can be fuzed to detonate on a specific radio frequency, these mines are extremely rare and unlikely to be encountered within a minefield. The life saving advantage of using a radio to call for help far outweighs the threat of radio frequency-activated mines. Submit a medical evacuation (MEDEVAC) report.

- b. **Assess** the situation.

- (1) Determine the nearest safe area not containing mines.

- (2) Determine the shortest route to the safe area.

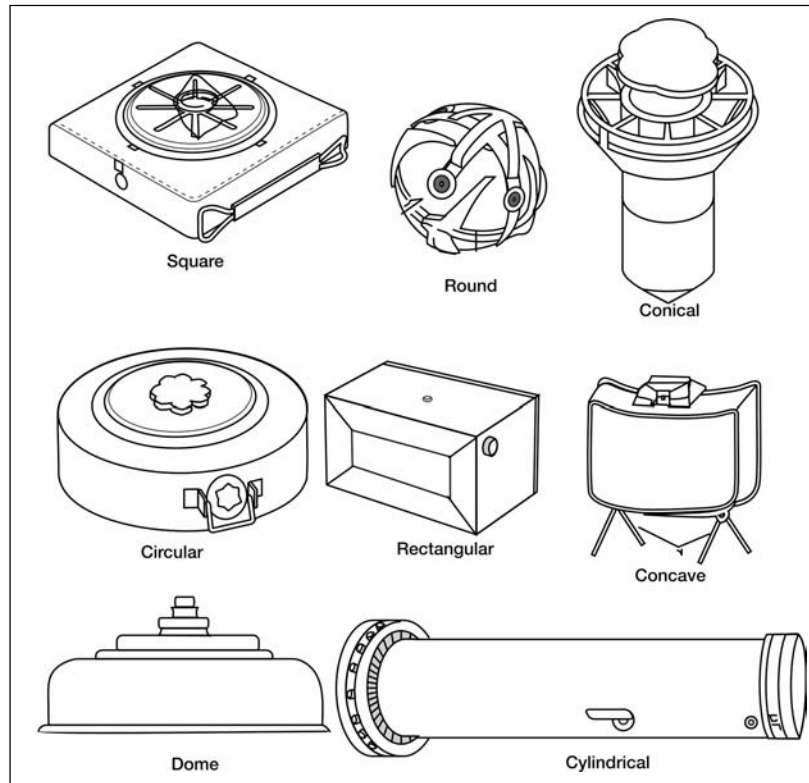
- (3) Determine if in the middle of a mined area.

- c. **Note** the situation.

- (1) Make notes about the mine that you see.

- (a) Describe the shape, and draw pictures if necessary (square, round, conical, circular, rectangular, concave, dome, or cylindrical) (Figure 052-192-1042-1).

**Performance Steps**



**Figure 052-192-1042-1. Samples of Mine Shapes**

**(b)** State the color (light green, dark green, brown, black, sand, camouflage, gray, metallic, natural wood, olive, blue, or white).

**(c)** Annotate the size.

**(d)** Annotate the material type. Most mines are made of plastic, plastic casting, wood, sheet metal, cast iron, metal alloys, concrete, Bakelite™, and cast explosive.

**(2)** Indicate the number of mines.

**(3)** Annotate the terrain considerations.

**(4)** Indicate the location.

---

## Performance Steps

---

**Note 1:** Stay where you are, if possible, when support is available. If support is delayed, consider probing a safe area to sit.

**Note 2:** Go to performance step 2 to perform self-extraction when footprints are not clearly visible (without a vehicle) or to perform casualty evacuation using the lane technique. Go to performance step 2b to perform the stepping-stone technique (no casualties). Go to performance step 3 to perform self-extraction from a vehicle. Go to performance step 4 to perform self-extraction when footprints are clearly visible (without a vehicle). Go to performance step 5 to perform actions after detecting a trip wire. Go to performance step 6 to perform actions after detecting a possible mine while probing.

**Note 3:** Consider clearing an area to place excess equipment, such as a ruck sack and load bearing equipment, if it is going to take a long time to reach a safe area.

**2.** Perform self-extraction when footprints are not clearly visible (without a vehicle).

**Note 1:** Carry a personal extraction kit. For example, as a minimum, carry 50 markers, pins, or poker chips; a trip wire feeler; and a probe (nonmetallic preferred). Use of a nonmetallic probe is recommended. When a nonmetallic probe is not available, probing tools can be made of any material as long as they are rigid enough to push through the soil, long enough to penetrate the ground at least 3 inches at a 30° angle, and small enough so that a soldier can continue the probing drill for several hours. Magnetic and nonmagnetic metal tools, such as bayonets, screwdrivers, and penknives are suitable for probing when a nonmetallic probe is not available.

**Note 2:** The prone position is the safest position to probe from because it reduces the casualty-causing effects of an accidental blast. The lane technique is normally performed for casualty evacuation.

**Note 3:** Use the stepping-stone technique when there are no casualties. This technique provides speed by minimizing the area probed and cleared for extraction. A probing soldier will not adopt the prone position while performing this technique. Go to performance step 2b for the stepping-stone technique.

- a. Assume the prone position.
  - (1) Squat down without touching your knees to the ground.
  - (2) Use the *look-feel-probe* procedure to clear the area.
    - (a) *Look* around for high and low trip wires. *Look* for mine indicators on the ground, to include mine fuzes, mine parts, or disturbed ground.
    - (b) *Feel* for trip wires using the trip wire feeler. Push the trip wire feeler forward along the ground from your feet to your front left, then front center, and then front right. Raise the trip wire feeler in a gentle upward sweeping action to above your head height.

---

**Performance Steps**

---

*Feel* the ground around your feet with your fingers using a slow sideways sweep, feeling for exposed mine fuze prongs or other mine parts.

**Note 1:** A trip wire feeler can be made of a light, wooden rod or stick; a light-gauge wire; plastic rods; or anything else that will allow you to feel a trip wire without activating it. The trip wire feeler must be a minimum of 24-inches long and a maximum of 36-inches long. The trip wire feeler should be stiff enough to be held straight out to the front, but not so stiff as to come in contact with a trip wire without you being able to feel the wire.

**Note 2:** Go to performance step 5 for performance actions taken after detecting a trip wire.

(c) *Probe* the area as far forward as comfortable.

Hold the probe in either hand, with the palm up, allowing the blunt end of the probe to extend beyond the cup of the palm.

Apply just enough pressure on the probe to sink it slowly into the ground at a 30° angle and to a depth of 3 inches (Figure 052-192-1042-2).

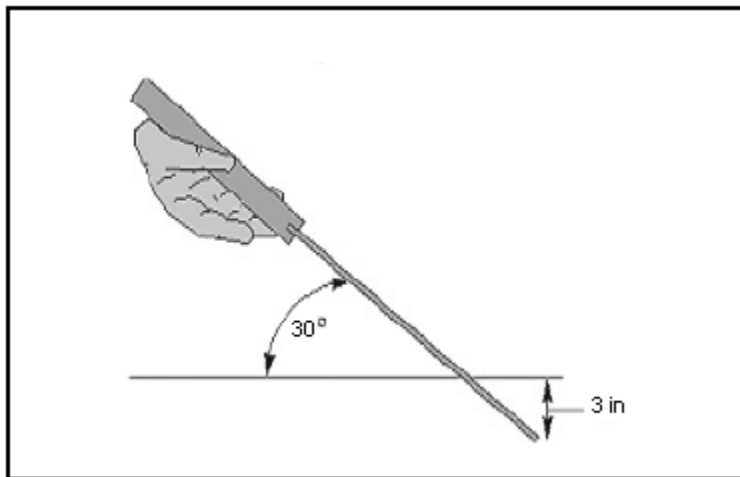


Figure 052-192-1042-2. Probing Technique Using a Suitable Probe

---

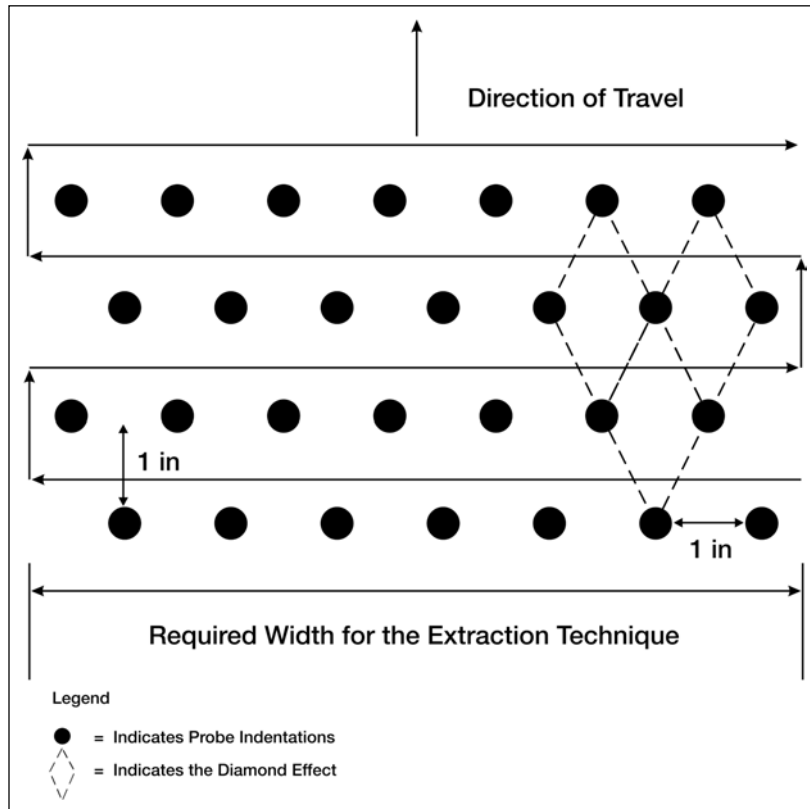
Performance Steps

**DANGER:**

**USE EXTREME CAUTION WHEN PROBING. IF YOU PROBE AT AN ANGLE OF MORE THAN 30°, THE PROBE TIP MAY DETONATE A MINE.**

(d) *Probe* every 1 inch across the required extraction width path (0.6 meter [24 inches] for self extraction, 1 meter for evacuating a casualty using the individual-carry technique, and 2 meters for evacuating a casualty using a litter), then move forward 1 inch and stagger (offset) the probe indentations from the previously probed row (Figure 052-192-1042-3).

**Performance Steps**



**Figure 052-192-1042-3. Probing Across the Required Extraction Width Path**

**Note:** Continue the probing technique and ensure that the probe indentations in each row are offset from the previously probed rows, thus creating a diamond shape.

**(3)** Kneel on the ground after the area is found to be clear, and continue probing forward until you can assume the prone position.

**(4)** Continue the *look-feel-probe* procedure across the required extraction width path until you reach a safe area or the casualty.

**Note:** Go to performance step 6 for actions taken after detecting a possible mine.



---

**Performance Steps**

---

(a) Clear up to and under the casualty in case he is lying on a mine.

(b) Clear and mark a 1-meter circumference around the casualty for individual-carry extraction or a 2-meter circumference for litter-carry extraction.

(c) Remove the casualty out of the mined area.

(5) Mark the area for mines.

(6) Inform higher headquarters with noted information using the UXO spot report (Figure 052-192-1042-4).

Line	
1	<b>Date-Time Group:</b> DTG item was discovered.
2	<b>Reporting Activity:</b> UIC and grid location.
3	<b>Contact Method:</b> Radio frequency, call sign, POC and telephone number.
4	<b>Type of Ordnance:</b> Dropped, projected, placed, or thrown. If available, supply the subgroup. Give the number of items, if more than one.
5	<b>NBC Contamination:</b> Be as specific as possible.
6	<b>Resources Threatened:</b> Report any equipment, facilities, or other assets that are threatened.
7	<b>Impact on Mission:</b> Provide a short description of your current tactical situation and how the presence of the UXO affects your status.
8	<b>Protective Measures:</b> Describe any measures you have taken to protect personnel and equipment.
9	<b>Recommended Priority:</b> Recommend a priority of response by EOD technicians or engineers.

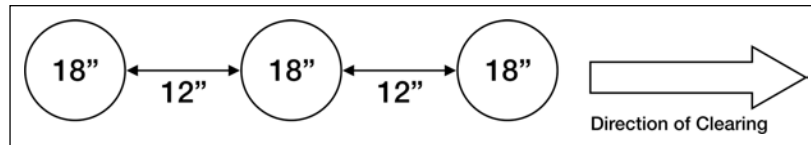
Figure 052-192-1042-4. UXO Spot Report

---

**Performance Steps**

---

- b. Use the stepping-stone technique (Figure 052-192-1042-5).



**Figure 052-192-1042-5. Stepping Stone Technique**

**Note:** Go to performance step 5 for actions taken after detecting a trip wire. Go to performance step 6 for performance actions taken after detecting a possible mine.

(1) Clear individual stepping-stone areas to step into by using the look-feel-probe procedure.

(2) Probe from a squatted position an area of 18 inches in diameter to your front to allow for both feet to stand in the area. The gap between stepping-stones should be no more than 12 inches.

(3) Step into the cleared area and reorient towards the previously determined safe area.

(4) Mark each stepping-stone perimeter or center.

(5) Continue the look-feel-probe procedure during the stepping-stone technique until a safe area is reached.

**Note:** The *look-feel-probe* procedure is performed the same as previously mentioned except the area probed is 18 inches in diameter.

(6) Mark the area for mines.

(7) Inform higher headquarters with noted information using the UXO spot report.

3. Perform self-extraction from a vehicle.

a. Stop immediately.

b. Radio the situation to higher headquarters, and remain in the vehicle.

c. Extract from the rear of the vehicle after all communication efforts have failed, and walk inside the visible tire track to the last known safe area.

---

## Performance Steps

---

### CAUTION

Tracked vehicle tracks may also be followed, but care must be taken as small antipersonnel mine fuzes have been known to be missed by the gaps in the track shoes. These mines pose a threat to personnel walking inside the vehicle track marks.

**Note:** Go to performance step 5 for actions taken after detecting a trip wire. Go to performance step 6 for performance actions taken after detecting a possible mine while probing.

- d. Perform the look-feel-probe procedure from the vehicle to the last known safe area if the tracks are not clearly visible.
  - e. Probe an area to step in from the vehicle before making contact with the ground.
  - f. Mark the area for mines.
  - g. Inform higher headquarters with noted information using the UXO spot report.
4. Perform self-extraction when footprints are clearly visible (without a vehicle).

### WARNING

This self-extraction method is the least preferred and should only be performed when time is the determining factor.

- a. Turn around carefully within your footprints, and follow the exact footprints back along the path entered.
  - b. Follow the footprints until clear of the threat.
  - c. Mark the area for mines.
  - d. Inform higher headquarters with noted information using the UXO spot report.
5. Perform the following actions after detecting a trip wire:

**Note:** When a trip wire is located, stand still and visually inspect the wire along its length to identify the possible mine location and trip wire anchor point.

### WARNING

Do not attempt to touch, move, or cut any trip wires that are found

- a. Identify the shortest route to probe around the trip wire.

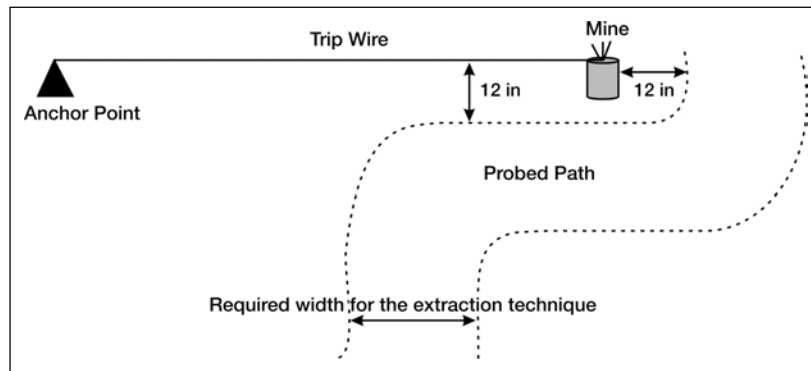
---

**Performance Steps**

---

b. Probe the required extraction width path (0.6 meter [24 inches] for self extraction, 1 meter for evacuating a casualty using the individual-carry technique, and 2 meters for evacuating a casualty using a litter), 12 inches away from but along the line of the trip wire until you safely bypass the hazard.

c. Mark the line of the trip wire along the ground surface 12 inches before the trip wire (Figure 052-192-1042-6).



**Figure 052-192-1042-6. Marking a Trip Wire**

6. Perform the following actions after detecting a possible mine while probing:

a. Stop probing when the probe encounters a solid object.

b. Investigate the solid object.

(1) Start excavation 6 inches back from the suspect object.

(2) Dig towards the suspected object using a suitable tool or your fingers in a sideward action.

**Note:** Periodically use the probe to verify the suspected mine location.

(3) Stop excavation when you encounter the solid object.

(a) Use two fingers from each hand to carefully remove the minimum amount of surrounding soil to confirm the object as a mine or not.

(b) Mark the location with a marker 6 inches to the rear of the mine if the object is confirmed as a mine. Continue moving forward if the object is not a mine.

---

**Performance Steps**

---

**WARNING**

Do not attempt to remove or disarm the mine. Report the hazard to higher headquarters.

(c) Bypass the marked mine and continue moving towards the safe area.

c. Mark either one or both sides of the cleared path as you move forward.

**Evaluation Preparation:** Provide the soldier with the items and information listed in the conditions. The soldier must perform the performance substeps in sequence to self-extract from a mined area. Performance steps 2 through 4 of this task indicate different situations while performing self-extraction.

Performance Measures	GO	NO GO
1. Took immediate action on observed indicators or confirmation of a mine.	—	—
a. Stopped immediately and gained control of himself.		
(1) Did not move his feet (no vehicle).		
(2) Remained in the vehicle.		
(3) Warned other elements operating in the area, and advised higher elements of the situation for possible support with extraction.		
b. Assessed the situation.		
(1) Determined the nearest safe area not containing mines.		
(2) Determined the shortest route to the safe area.		
(3) Determined if in the middle of a mined area.		
c. Noted the situation.		
(1) Made notes about the mine.		
(a) Described the shape, and drew pictures if necessary (square, round, conical, circular, rectangular, concave, dome, or cylindrical).		

Performance Measures	GO	NO GO
(b) Stated the color (light green, dark green, brown, black, sand, camouflage, gray, metallic, natural wood, olive, blue, or white).		
(c) Annotated the size.		
(d) Annotated the material type. Most mines are made of plastic, plastic casting, wood, sheet metal, cast iron, metal alloys, concrete, Bakelite™, and cast explosive.		
(2) Indicated the number of mines.		
(3) Annotated the terrain considerations.		
(4) Indicated the location.		
2. Performed self-extraction when footprints were not clearly visible (without a vehicle).	—	—
a. Assumed the prone position.		
(1) Squatted down without touching his knees to the ground.		
(2) Used the look-feel-probe procedure to clear the area.		
(a) Looked around for high and low trip wires. Looked for mine indicators on the ground, to include mine fuzes, mine parts, or disturbed ground.		
(b) Felt for trip wires using the trip wire feeler. Pushed the trip wire feeler forward along the ground from his feet to his front left, then front center, and then front right. Raised the trip wire feeler in a gentle upward sweeping action to above head height. Felt the ground around his feet with his fingers using a slow sideways sweep, feeling for exposed mine fuze prongs or other mine parts.		
(c) Probed the area as far forward as comfortable. Held the probe in either hand, with the palm up, allowing the blunt end of the probe to extend beyond the cup of the palm. Applied just enough pressure on the probe to sink it slowly into the ground at a 30° angle and to a depth of 3 inches.		

Performance Measures	GO	NO GO
(d) Probed every 1 inch across the required extraction width (0.6 meter [24 inches] for self extraction, 1 meter for evacuating a casualty using the individual-carry technique, and 2 meters for evacuating a casualty using a litter), then moved forward 1 inch and staggered (offset) the probe indentations from the previously probed row.		
(3) Kneeled on the ground after the area was found to be clear, and continued probing forward until he could assume the prone position.		
(4) Continued the look-feel-probe procedure across the required extraction width path until he reached a safe area or the casualty.		
(a) Cleared up to and under the casualty in case he was lying on a mine.		
(b) Cleared and marked a 1-meter circumference around the casualty for individual-carry extraction or a 2-meter circumference for litter-carry extraction.		
(c) Removed the casualty out of the mined area.		
(5) Marked the area for mines.		
(6) Informed higher headquarters with noted information using the UXO spot report.		
b. Used the stepping-stone technique.		
(1) Cleared individual stepping-stone areas to step into by using the look-feel-probe procedure.		
(2) Probed from the squatted position an area of 18 inches in diameter to his front to allow for both feet to stand in the area. The gap between stepping-stones was no more than 12 inches.		
(3) Stepped into the cleared area and reoriented towards the determined safe area.		
(4) Marked each stepping-stone perimeter or center.		
(5) Continued the look-feel-probe procedure during the stepping-stone technique until a safe area was reached.		

Performance Measures	GO	NO GO
(6) Marked the area for mines.		
(7) Informed higher headquarters with noted information using the UXO spot report.		
3. Performed self-extraction from a vehicle.	___	___
a. Stopped immediately.		
b. Radioed the situation to higher headquarters, and remained in the vehicle.		
c. Extracted from the rear of the vehicle after all communication efforts failed, and walked inside the visible vehicle tire track to the last known safe area.		
d. Performed the look-feel-probe procedure from the vehicle to the last known safe area if the tracks were not clearly visible.		
e. Probed an area to step in from the vehicle before making contact with the ground.		
f. Marked the area for mines.		
g. Informed higher headquarters with noted information using the UXO spot report.		
4. Performed self-extraction when footprints were clearly visible (without a vehicle).	___	___
a. Turned around carefully within his footprints, and followed the exact footprints back along the path entered.		
b. Followed the footprints until clear of the threat.		
c. Marked the area for mines.		
d. Informed higher headquarters with noted information using the UXO spot report.		
5. Performed the following actions after detecting a trip wire:	___	___
a. Identified the shortest route to probe around the trip wire.		
b. Probed the required extraction width path (0.6 meter [24 inches] for self extraction, 1 meter for evacuating a casualty using the individual-carry technique, and 2 meters for evacuating a casualty using a litter), 12 inches away from but along the line of the trip wire until he safely bypassed the hazard.		



Performance Measures	GO	NO GO
c. Marked the line of the trip wire along the ground surface 12 inches before the trip wire.		
6. Performed the following actions after detecting a possible mine while probing:	___	___
a. Stopped probing when the probe encountered a solid object.		
b. Investigated the solid object.		
(1) Started excavation 6 inches back from the suspected object.		
(2) Dug towards the suspected object using a suitable tool or his fingers in a sideward action.		
(3) Stopped excavation when he encountered the solid object.		
(a) Used two fingers from each hand to carefully remove the minimum amount of surrounding soil to confirm the object as a mine or not.		
(b) Marked the location with a marker 6 inches to the rear of the mine if the object was a mine. Continued moving forward if the object was not a mine.		
(c) Bypassed the marked mine and continued moving towards the safe area.		
c. Marked either one or both sides of the cleared path as he moved forward.		

**Evaluation Guidance:** Score the soldier GO if all performance measures are passed (P). Score the soldier NO GO if any performance measure is failed (F). If the soldier scores NO GO, show the soldier what was done wrong and how to do it correctly.

#### References

##### Required

##### Related

FM 20-32  
GTA 05-10-044  
TC 20-32-5

---

## 052-192-1242

### Locate Mine and Booby Trap Indicators by Visual Means

**Conditions:** Given an urban/rural area, (containing mine and booby trap indicators) to maneuver in, around or through in support of missions and operations.

**Standards:** Visually locate all mine/booby trap indicators, and improvised markings in the prescribed area without causing injury to personnel and damage to equipment. Report indicators to immediate supervisor.

---

### Performance Steps

1. Gather information pertaining to mines and booby traps associated with the area of operations through—
  - a. Leader disseminated information.
  - b. References (graphic training aids, land mine handbooks, and special publications).
  - c. Mine boards.
  - d. Reports.
  - e. Intelligence briefs.
  - f. Operation orders.
2. Recognize mine and booby trap indicators during movement.

**Note:** The only true indicators that there are mines or booby traps present are if someone spots a mine or booby trap or if a person or vehicle detonates a mine or booby trap. Spotting mines or booby traps as an initial indicator is extremely rare and should not be the primary focus of checking for mines or booby traps.

**CAUTION**

You must be alert for signs of anything out of place or unnatural as you maneuver through an area. If you see something that is a possible indicator, the element must *stop*, assess the indicator, and look for other indicators to confirm or deny the suspicious area before continuing or taking further action.

---

## Performance Steps

---

### WARNING

Unexploded ordnance (UXO) is a hazard on the battlefield. UXO includes ordnance items that have been fired, projected, dropped, or placed in such a way that they could become armed and go off. Whether in an area by design or accident, these items have not yet functioned. Whatever the reason, UXO poses the risk of injury or death to all personnel in its immediate vicinity. Once recognized, never approach any closer to a UXO.

**Note:** Refer to the task number 093-401-5040 (React to Unexploded Ordnance Hazards) for information on identifying and taking immediate actions when dealing with a UXO.

#### a. Mine and booby trap indicators.

**Note:** With the exception of stake mines and the majority of directional fragmentation mines, most hand or mechanically laid mines are buried. Once burying a mine has disturbed the natural surface of the ground, nature usually has a way of showing where this event took place. Unusual erosion, plant growth, or animal casualties may be vital clues to alert you that there might be mines, booby traps, improvised explosive devices (IEDs), or UXOs present.

##### (1) Dead animals with missing or damaged limbs.

**Note:** The animal may have walked several miles before dying.

##### (2) Human remains.

(a) Overgrown, unattended fields and pastures next to cultivated used areas.

(b) Trees and bushes not collected for firewood.

(3) Damaged vehicles left on or off the road.

(4) Wilted or dead patches of vegetation.

(5) Circles of lush grass among thin grass.

(6) Odd features in the ground or patterns that are not normally present in nature.

(7) Unattended vehicles, trailers, or boxes and abandoned military equipment such as weapons, ammunition, uniforms, or papers.

### CAUTION

These indicators may represent an IED or booby trap. Be alert for wires, detonating cord, or a shock tube running from these devices to the roadside. Cables or wires used in command detonated devices are sometimes buried, so look for disturbed soil in lines running up to the road and away from the suspected area.

##### (8) Disturbed ground.

---

### Performance Steps

---

- (a) Depressions in the ground (regular or odd spacing).
- (b) Raised patches of earth (regular or odd spacing).
- (9) Unused paths, routes, or trails.
- (10) Debris on or along a route.
- (11) Signs of road repair (such as new fill, pavement, patches, ditches, or culverts).

**Note:** There may be signs of single holes or several holes, possibly in some form of a pattern at tactical or key locations.

- (12) Potholes in tracks.
- (13) Disturbances in previous tire tracks or tracks that stop unexplainably.
- (14) Craters.
- (15) Areas avoided by local civilians.
- (16) Patterns of objects that could be used as a sighting line.
- (17) Mine or explosive packaging.
- (18) Patches of new brick work, plaster, or mud on walls
- (19) Abandoned defensive positions, trenches, and destroyed buildings.
- (20) Abandoned buildings, piles of wood, or materials not claimed by the locals.

**CAUTION**

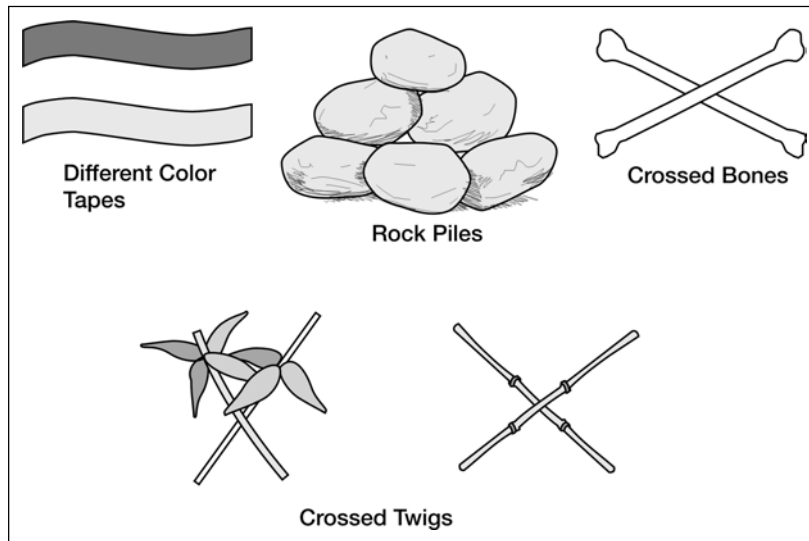
Buildings are excellent sites for booby traps. Assume that all unsecured buildings are booby-trapped.

- (21) Trip wires, strings, or cables.
  - (22) Evidence of electrical wires, batteries, mouse traps, clothes pins, steel tubes, or springs.
  - (23) Small shiny metal plates, split lightweight bomb casings, empty cluster bomb canisters, and small parachutes or drogues (funnel shaped drag chute) from submunitions (all indicators of cluster bomb strikes or scatterable-mine attacks).
- b.** Improvised markings of mines, booby traps, and UXOs (Figure 052-192-1242-1).

---

## Performance Steps

---



**Figure 052-192-1242-1. Samples of Mine Markings**

**Note:** Not all armies and fighting organizations mark their minefields to the same standards as required by the United States (US) Army. Many local factions, militia, or units will lay mines and mark them in their own way with readily available materials rather than formal markings. These markings are generally used to warn their own troops and local civilians of the presence of mines, booby traps, IEDs, or UXOs. Friendly units operating in these environments must gain this local knowledge in order to identify mine markers and hazardous areas.

(1) Rock piles or individual rocks painted red are United Nations (UN), threat army, or local-faction danger area markers.

**Note:** Used by the various fighting factions and locals to mark the minefield perimeters.

(2) Different color tapes attached to a stick, tree limb, picket, pole, or wall.

(3) Crossed bones, sticks, or twigs.

(4) Rows of light colored or painted white stones.

**Note:** Used by the UN to mark safe lanes and cleared areas. Stones are usually in regular patterns and close together.

(5) Circle of stones surrounding objects.

---

### Performance Steps

---

**Note:** Signs used by locals to mark individual mines and UXOs. Where there is one mine or explosive hazard, there are usually more in the area.

(6) Pieces of both cloth and metal material attached to poles, sticks, or walls.

(7) Burned fields normally indicate UN mine clearance operations.

(8) Red lettering and marks painted on rock faces or building walls. For example, start point (SP), indicating minefield start point. UN demining reference markers, such as reference point (RP) and benchmark (BM). Minefields will be close to these markers.

c. Man-made markings of mines, booby traps, IEDs, and UXOs (Figure 052-192-1242-2).

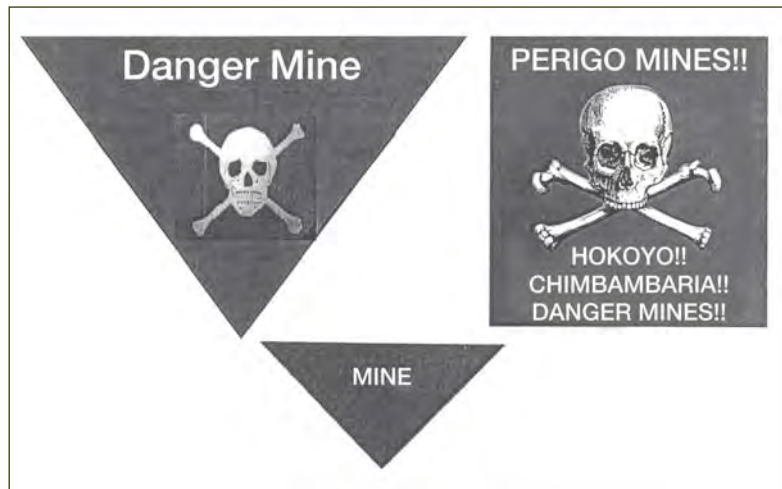


Figure 052-192-1242-2. Samples of Mine Signs

(1) Red rectangular or triangular signs attached to wire, stakes, posts, or pickets with a written warning on one side.

**Note:** Generally, if you can read the writing, you are on the safe side.

(2) Triangular signs with a picture of someone being blown up by a mine.

(3) Ongoing UN minefield clearance operations are delineated with wooden posts with red and white tops.

(4) Burned fields, indicating UN mine clearance operations.

---

**Performance Steps**

---

3. Report all suspected areas to the immediate supervisor.

**Evaluation Preparation:** Setup: Provide an area which contains suspected mine and booby trap indicators. Record and provide description of all suspected mine, booby trap indicators and locations on the evaluation sheet.

Performance Measures	GO	NO GO
1. Gathered information pertaining to mines and booby traps associated with the area of operations.	___	___
2. Recognized mine and booby trap indicators during movement.	___	___
3. Reported all suspected areas to the immediate supervisor.	___	___

**Evaluation Guidance:** Score the soldier GO if all performance measures are passed (P). Score the soldier NO-GO if any performance measure is failed. If the soldier fails any performance measure, show him how to do it correctly.

**References****Required****Related**

FM 20-32  
GTA 05-10-044  
TC 20-32-5

---

**071-326-0502****Move Under Direct Fire**

**Conditions:** Given a tactical situation approach an enemy position from a distance of 250 to 300 meters across varied terrain and armed with an M16A1 rifle or M203 grenade launcher. You are a member of a two-man team and wearing LCE.

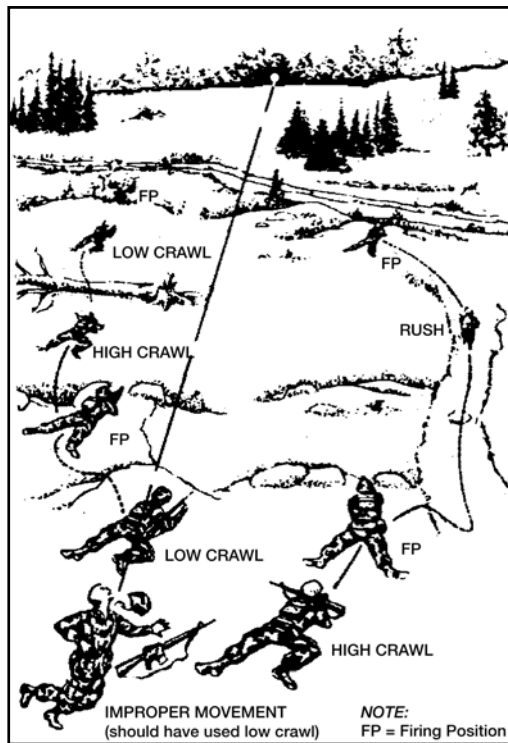
**Standards:** Moved to within 100 meters of the enemy position, using the correct individual tactical fire and movement techniques dictated by terrain features. Coordinated movement with team members and provided covering fire for each member.

---

**Performance Steps**

---

1. Select an individual movement route within your team or squad route or axis of advance (figure 071-326-0502-1).



- a. Search the terrain to your front for—

- (1) A gully, ravine, ditch, or wall at a slight angle to your direction of movement.

**Note.** These features provide cover and concealment when using the low or high crawl.

- (2) Hedgerows or a line of thick vegetation.
-



---

### Performance Steps

---

**Note.** These features provide only concealment when using the low or high crawl.

(3) Large trees, rocks, stumps, fallen timber, rubble, vehicle hulks, folds or creases in the ground.

**Note.** These features provide cover and concealment for use as temporary positions. Use the rush if the area between them has no concealment.

(4) High grass or weeds.

**Note.** These features provide only partial concealment. You can use the rush since the use of the high or low crawl could reveal your location by the movement of vegetation.

b. Select your next position (and the route to it) as one that—

(1) Exposes you to the least enemy fire.

(2) Does not require you to cross in front of other members of your element, masking their fires.

2. Determine the correct individual movement technique.

a. Select the high crawl when—

(1) Route provides cover and concealment.

(2) Poor visibility reduces enemy observation.

(3) Speed is required but the terrain and vegetation are suitable only for the low crawl.

b. Select the low crawl when—

(1) The route provides cover or concealment less than one foot high.

(2) Visibility provides the enemy good observation.

(3) Speed is not required.

c. Select the rush when—

(1) You must cross open areas.

(2) Time is critical.

3. Communicate the movement plan to your buddy or team leader using hand signals so the soldier not moving can cover by fire any movement by the other soldier.

**Note.** When moving as a member of a fire team, watch and listen to your team leader who will lead you along the best route and ensure that covering fire is provided when you move. Stay with your team leader and follow his example.

4. Use the high crawl (figure 071-326-0502-2).

---

---

**Performance Steps**

---



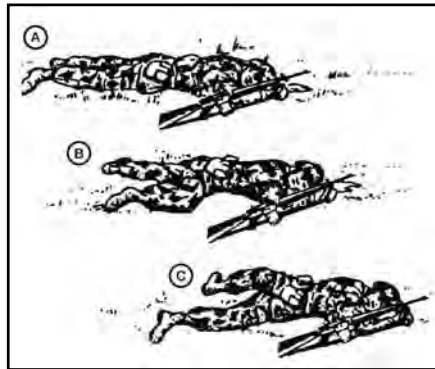
**Figure 071-326-0502-2. High crawl**

- a. Keep your body off the ground
  - b. Rest your weight on your forearms and lower legs.
  - c. Cradle your weapon in your arms, keeping its muzzle off the ground.
  - d. Keep your knees well behind your buttocks so it stays low.
  - e. Move forward by alternately advancing your right elbow and left knee, and left elbow and right knee.
5. Use the low crawl (figure 071-326-0502-3).
- a. Keep your body as flat as possible to the ground.
  - b. Hold your weapon by grasping the sling at the upper sling swivel, letting the handguard rest on your forearm and the butt of the weapon drag on the ground, thus keeping the muzzle off the ground.
  - c. Move forward by—
    - (1) Pushing both arms forward while pulling your right leg forward.
    - (2) Pulling with both arms while pushing with your right leg.
    - (3) Continuing this push-pull movement until you reach your next position, changing your pushing leg frequently to avoid fatigue.

---

**Performance Steps**

---



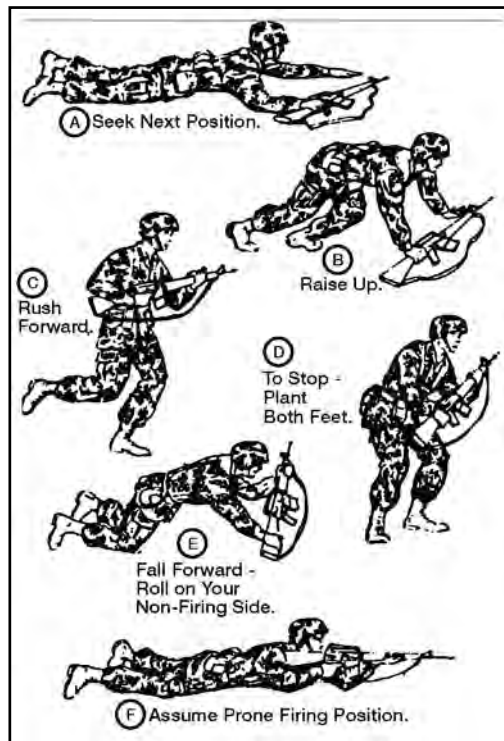
**Figure 071-326-0502-3. Low crawl**

- 6.** Use the rush to move from one covered position to another when enemy fire allows brief exposure (figure 071-326-0502-4).
- a.** Move from your firing position by rolling or crawling.
  - b.** Start from the prone position.
  - c.** Select your next position by slowly raising your head.
  - d.** Lower your head while drawing your arms into your body, keeping your elbows down, and pulling your right leg forward.
  - e.** Raise your body in one movement by straightening your arms.
  - f.** Spring to your feet, stepping off with either foot.
  - g.** Run to the next position--
    - (1)** Keeping the distance short to avoid accurate enemy fire.
    - (2)** Trying not to stay up any longer than 3 to 5 seconds so that the enemy does not have time to track you with automatic fire.
-

---

**Performance Steps**

---



**Figure 071-326-0502-4. Rush**

- h.** Plant both feet just before hitting the ground.
  - i.** Fall forward by:
    - (1)** Sliding your right hand down to the heel of the butt of your weapon.
    - (2)** Breaking your fall with the butt of your weapon.
  - j.** Assume a firing position.
    - (1)** Roll on your side.
    - (2)** Place the butt of your weapon in the hollow of your shoulder.
    - (3)** Roll or crawl to a covered or concealed firing position.
- 7.** Cover your buddy's movement with fire.
-

**Evaluation Preparation:**

*Setup:* Take soldiers on a simulated march or field exercise in battle dress with LCE and weapons. Select an area with varying cover types and heights. Select a site about 300 meters away to serve as an enemy position. Point out the site to the soldiers. Pair up soldiers being tested.

*Brief Soldier:* Tell the soldiers to pretend they are under direct fire. Tell them to move from their present position to within 100 meters of the enemy position using the buddy system. Tell the soldiers to use the appropriate movement technique employing performance measures 4, 5, and 6 as appropriate for the scenario and terrain. It may not be appropriate for each soldier to use all three techniques.

Performance Measures	GO	NO GO
1. Selected an individual movement route within the team or squad route or axis of advance that provided cover or concealment such as:	___	___
a. A gully, ravine, ditch, or wall at a slight angle to the direction of movement.		
b. Hedgerows or a line of thick vegetation.		
c. Large trees, rocks, stumps, fallen timber, rubble, vehicle hulks, folds or creases in the ground.		
d. High grass or weeds.		
2. Selected the next position (and the route to it) as one that—	___	___
a. Exposed you to the least enemy fire.		
b. Did not require you to cross in front of other members of your element, masking their fires.		
3. Determined the correct movement technique.	___	___
a. Selected the high crawl when--		
(1) The route provided cover and concealment.		
(2) Poor visibility reduced enemy observation.		
(3) Speed was required but the terrain and vegetation was suitable only for the low crawl.		
b. Selected the low crawl when—		
(1) The route provided cover or concealment less than 1 foot high.		
(2) Visibility provided the enemy good observation.		

Performance Measures	GO	NO GO
(3) Speed was not required.		
c. Selected the rush when—		
(1) Crossing open areas.		
(2) Time was critical.		
4. Communicated movement plan using hand signals so that the soldier not moving could cover by fire any movement by the other soldier.	___	___
5. Used the high crawl.	___	___
a. Kept body off the ground.		
b. Rested weight on forearms and lower legs.		
c. Cradled weapon in, keeping its muzzle off the ground.		
d. Kept knees well behind buttocks.		
e. Moved forward by alternately advancing right elbow and left knee, and left elbow and right knee.		
6. Used the low crawl.	___	___
a. Kept body as flat as possible to the ground.		
b. Held weapon by grasping the sling at the upper sling swivel, letting the handguard rest on forearm and the butt of the weapon drag on the ground, thus keeping the muzzle off the ground.		
c. Moved forward by—		
(1) Pushed both arms forward while pulling right leg forward.		
(2) Pulled with both arms while pushing with right leg.		
(3) Continued push-pull movement until reaching next position; changed pushing leg frequently to avoid fatigue.		
7. Used the rush to move from one covered position to another.	___	___
a. Moved from firing position by rolling or crawling.		
b. Started from the prone position.		
c. Selected next position by slowly raising head.		

Performance Measures	GO	NO GO
d. Lowered head while drawing arms in, keeping elbows down, and pulling right leg forward.		
e. Raised body in one movement by straightening arms.		
f. Sprang to feet, stepping off with either foot.		
g. Ran to the next position--		
(1) Kept the distance short.		
(2) Did not stay up any longer than 3 to 5 seconds.		
h. Planted both feet just before hitting the ground.		
i. Fell forward by--		
(1) Sliding right hand down to the heel of the butt of weapon.		
(2) Breaking fall with the butt of the weapon.		
j. Assumed a firing position.		
(1) Rolled on side.		
(2) Placed the butt of the weapon in the hollow of shoulder.		
(3) Rolled or crawled to a covered or concealed firing position.		
8. Covered buddy's movement with fire.	___	___

**Evaluation Guidance:** Score the soldier GO if all performance measures are passed. The soldier should perform performance measures 4, 5, and 6 as appropriate for the scenario and terrain. Score the soldier NO GO if any performance measure is failed. If the soldier scores NO GO, show him what was done wrong and how to do it correctly.

#### References

**Required**  
FM 21-75

**Related**

---

## 071-326-0503

### Move Over, Through, or Around Obstacles (Except Minefields)

**Conditions:** Given individual weapon, load carrying equipment (LCE), one smoke grenade, wood or grass mats or chicken wire, a grappling hook, wrapping material, wire cutters (optional) and a buddy. During daylight or darkness, you are at a field location, moving over a route with natural and man-made crossings and obstacles (walls and barbed wire entanglements).

**Standards:** Approached within 100 meters of a suspected enemy position over a specified route. Negotiated each obstacle within the time designated while retaining all equipment without becoming a casualty to a booby trap or early warning device.

---

#### Performance Steps

1. Cover your advance using smoke when crossing an obstacle. (Task 071-325-4407, Employ Hand Grenades.)
2. Ensure your buddy is covering you since obstacles are normally covered by either fire or observation.
3. Cross barbed wire obstacles.

**WARNING**

It is threat doctrine to attach tripwire-activated mines to barbed wire.

- a. Check barbed wire for booby traps or early warning devices.
    - (1) Look for booby traps or early warning devices attached to the barbed wire.
    - (2) Throw a grappling hook with a length of rope attached over the barbed wire.
    - (3) Pull the rope to set off any booby traps or early warning devices.
  - b. Cross over barbed wire using wood, grass mats, or some chicken wire to protect you from the barbs.
    - (1) Throw the wood, mat, or chicken wire over the barbed wire.
    - (2) Cross carefully because such a mat or net forms an unstable path.
  - c. Cross under barbed wire.
    - (1) Slide headfirst on your back under the bottom strands.
    - (2) Push yourself forward with your shoulders and heels, carrying your weapon lengthwise on your body, and holding the barbed wire with one hand while moving.
-



---

**Performance Steps**

---

- (3) Let the barbed wire slide on the weapon to keep wire from catching on clothing and equipment.
  - d. Cut your way through barbed wire.
    - (1) Leave the top wire in place to make it less likely that the enemy will discover the gap.
    - (2) Wrap cloth around the barbed wire between your hands.
    - (3) Cut partly through the barbed wire.
    - (4) Bend the barbed wire back and forth quietly until it separates.
    - (5) Cut only the lower strands.
- 4. Cross exposed danger areas such as roads, trails, or small streams.
  - a. Select a point at or near a bend in the road or stream. If possible, select a bend that has cover and concealment on both sides.
  - b. Crawl up to the edge of the open area.
  - c. Observe the other side carefully before crossing.
  - d. Move rapidly but quietly across the exposed area.
  - e. Take cover on the other side.
  - f. Check the area around you.
- 5. Cross over a wall.
  - a. Roll quickly over the top.
  - b. Do not go over standing upright.
- 6. Cover your buddy as he crosses the obstacle.

---

**Evaluation Preparation:** Setup: Select a field location that has crossings, walls, and barbed wire entanglements. Designate a suspected opposing forces position and point it out to the soldiers. Establish a standard by timing yourself and an assistant as you run the course twice. Average times and add 10 percent as maximum time for soldiers.

**Brief Soldier:** Tell soldiers they are going to be evaluated on how they move over, through, and around the obstacles while attempting to get within 100 meters of an enemy position. Tell them they must negotiate at least one of each type obstacle: exposed danger areas, barbed wire, and a wall. Tell them they must run the course within the standard.

Performance Measures	GO	NO GO
1. Covered your advance using smoke.	___	___
2. Ensured buddy was covering you.	___	___

<b>Performance Measures</b>	<b>GO</b>	<b>NO GO</b>
<b>3. Crossed barbed wire obstacles.</b>	—	—
<b>a. Checked barbed wire for booby traps or early warning devices.</b>		
<b>(1) Looked for booby traps or early warning devices attached to the barbed wire.</b>		
<b>(2) Threw a grappling hook with a length of rope attached over the barbed wire.</b>		
<b>(3) Pulled the rope to set off any booby traps or early warning devices.</b>		
<b>b. Crossed over barbed wire using wood, grass mats, or some chicken wire.</b>		
<b>(1) Threw the wood, mat, or chicken wire over the barbed wire.</b>		
<b>(2) Crossed carefully because such a mat or net forms an unstable path.</b>		
<b>c. Crossed under barbed wire.</b>		
<b>(1) Slid headfirst on back under the bottom strands.</b>		
<b>(2) Pushed forward with shoulders and heels, carrying weapon lengthwise on body and holding the barbed wire with one hand while moving.</b>		
<b>(3) Let the barbed wire slide on the weapon so that the wire did not catch on clothing and equipment.</b>		
<b>d. Cut through barbed wire.</b>		
<b>(1) Left the top wire in place.</b>		
<b>(2) Wrapped cloth around the barbed wire between hands.</b>		
<b>(3) Cut partly through the barbed wire.</b>		
<b>(4) Bent the barbed wire quietly until it separated.</b>		
<b>(5) Cut only the lower strands.</b>		
<b>4. Crossed exposed danger areas such as roads, trails, or small streams.</b>	—	—
<b>a. Selected a point at or near a bend in the road or stream that had cover and concealment on both sides.</b>		
<b>b. Crawled up to the edge of the open area.</b>		
<b>c. Observed the other side carefully before crossing.</b>		

Performance Measures	GO	NO GO
d. Moved rapidly but quietly across the exposed area.		
e. Took cover on the other side.		
f. Checked the surrounding area.		
5. Crossed over a wall.	___	___
a. Rolled quickly over the top.		
b. Did not go over standing upright.		
6. Covered buddy as he crossed the obstacle.	___	___

**Evaluation Guidance:** Score the soldier GO if all performance measures are passed. Score the soldier NO GO if any performance measure is failed. If the soldier scores NO GO, show him what was done wrong and how to do it correctly.

#### References

**Required**  
FM 21-75

**Related**

---

### 071-326-0510

#### React to Indirect Fire While Dismounted

**Conditions:** You are a member (without leadership responsibilities) of a squad or team. You are either in a defensive position or moving on foot. You hear incoming rounds, shells exploding or passing overhead, or someone shouting "incoming."

**Standards:** Reacted to each situation by shouting "Incoming," followed the leader's directions, if available. Took or maintained cover.

---

#### Performance Steps

1. Shout "incoming" in a loud, easily recognizable voice.
2. Look to your leader for additional instructions.
3. Remain in your defensive position (if appropriate), making no unnecessary movements that could alert the enemy to your location.
4. Take cover outside the impact area (if you are in an exposed position or moving), keeping the body low if the leader is not in sight.

---

#### Evaluation Preparation:

*Setup:* Take the soldiers on a simulated march or field exercise.

*Brief Soldier:* Tell the soldiers they must react to indirect fire on the move and when in a fixed position, when they receive the command "Incoming!"

Performance Measures	GO	NO GO
1. Shouted "incoming" in a loud, easily recognizable voice.	___	___
2. Looked to leader for additional instructions.	___	___
3. Remained in defensive position (if appropriate), making no unnecessary movements that could alert the enemy to your location.	___	___
4. Took cover outside the impact area (if you were in an exposed position or moving), keeping the body low if the leader was not in sight.	___	___

**Evaluation Guidance:** Score the soldier GO if all performance measures are passed. Score the soldier NO GO if any performance measure is failed. If the soldier scores NO GO, show him what was done wrong and how to do it correctly.

**References**

**Required**

FM 21-75

**Related**

---

**071-326-0511**

**React to Flares**

**Conditions:** Given a tactical situation at night, upon hearing a flare rising or when suddenly illuminated by a ground or overhead flare.

**Standards:** Reacted to a ground or an overhead flare without being seen by the enemy or losing night vision.

---

**Performance Steps**

1. Respond to ground flares.
    - a. Move out of the illuminated area.
    - b. Reorient yourself when alone or in a group by SOP, or as instructed.
    - c. Continue the mission.
  2. Respond to an overhead flare with warning (for example, the sound of a rising flare).
-

---

**Performance Steps**

---

- a. Assume the prone position (behind concealment when available) before the flare bursts.
  - b. Protect your night vision by closing one eye and observing with the other.
  - c. Use your night vision eye to reorient yourself or rejoin your group when the flare burns out.
  - d. Continue the mission.
3. Respond to an overhead flare without warning.
- a. Assume the prone position behind concealment (when available) until the flare burns out.
  - b. Protect your night vision by closing one eye and observing with the other.
  - c. Crouch low until the flare burns out when crossing wire obstacles where the prone position is not possible.
  - d. Use your night vision eye to reorient yourself or rejoin your group when the flare burns out.
  - e. Continue the mission.
- 

**Evaluation Preparation:** Setup: Have ground flares set so that you can ignite them. Have hand-held flares to use to simulate the overhead flares.

**Brief Soldier:** Tell the soldier that he is to react to the flares as they appear. After grading the soldier on the ground flare and the overhead flare with warning, tell him that the next flare should be acted on only after the flare has burst (simulate "without warning").

Performance Measures	GO	NO GO
1. Responded to a ground flare.	___	___
a. Moved out of the illuminated area.		
b. Reoriented alone or in a group.		
c. Continued the mission.		
2. Responded to an overhead flare with warning.	___	___
a. Assumed the prone position before the flare burst.		
b. Protected night vision by closing one eye and observing with the other eye.		
c. Reoriented or rejoined group when the flare burned out.		

Performance Measures	GO	NO GO
d. Continued the mission.		
3. Responded to an overhead flare without warning.	___	___
a. Assumed the prone position until the flare burned out.		
b. Protected night vision by closing one eye and observing with the other eye.		
c. Crouched low until the flare burned out when crossing wire obstacles when the prone position was not possible.		
d. Used night vision eye to reorient or rejoin group when the flare burned out.		
e. Continued the mission.		

**Evaluation Guidance:** Score the soldier GO if all performance measures are passed. Score the soldier NO GO if any performance measure is failed. If the soldier scores NO GO, show him what was done wrong and how to do it correctly.

#### References

**Required**  
FM 21-75

**Related**

---

### 071-326-0513

#### Select Temporary Fighting Positions

**Conditions:** You must select a temporary fighting position when at an overwatch position, after initial movement into a tentative defensive position, at a halt during movement, or upon receiving direct fire.

**Standards:** Selected a firing position that protected you from enemy observation and fire, and allowed you to place effective fire on enemy positions without exposing most of your head and body.

---

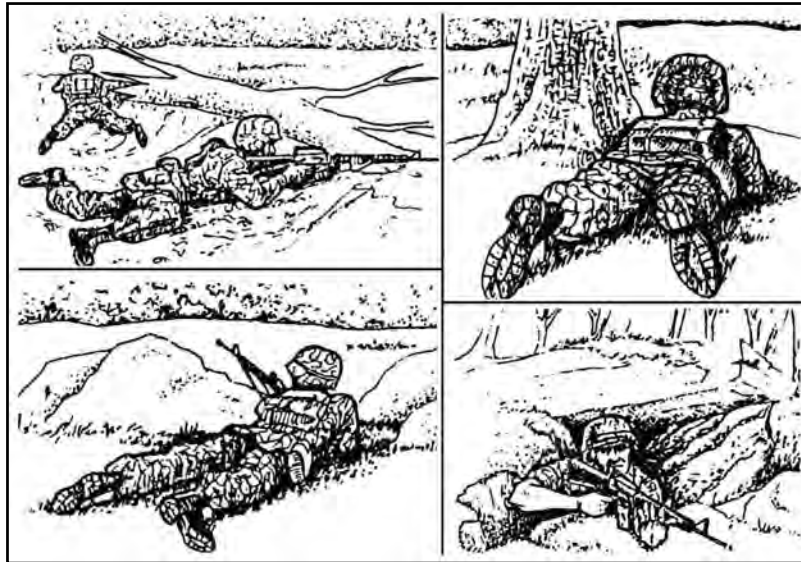
#### Performance Steps

1. Choose a position that takes advantage of available cover and concealment (figure 071-326-0513-1).
-

---

**Performance Steps**

---



**Figure 071-326-0513-1. Temporary fighting positions**

**Note.** Cover gives protection from bullets, fragments of exploding rounds, flame, nuclear effects, and biological and chemical agents. Cover can also conceal you from enemy observation. Cover can be natural or man-made. Concealment is anything that hides you from enemy observation. Concealment DOES NOT protect you from enemy fire. DO NOT think that you are protected from the enemy's fire just because you are concealed. Concealment, like cover, can also be natural or man-made.

2. Choose a position that allows you to observe and fire around the side of an object while concealing most of your head and body.

3. Choose a position that allows you to stay low when observing and firing, whenever possible.

**Note.** This position allows you to aim better and take advantage of concealing vegetation.

4. Choose a position with a background that does not silhouette you against the surrounding environment.

**Note.** A position like this reduces your chances of being detected.

5. Follow your leader's directions after your initial selection of a temporary battlefield position.

---

---

**Performance Steps**

---

**Note.** Your leader may reposition you to gain better coverage of the area.

---

**Evaluation Preparation:** Setup: Evaluate this task during a march or a simulated march in an area with varying degrees of cover and concealment. Have the soldiers in full battle gear.

**Brief Soldier:** Tell each soldier the enemy has been reported in the area and may be encountered at any time. At preselected points during the march, at a rest halt, after ordering the soldier to take an overwatch position, or after ordering the soldier to take a tentative defensive position, have him select a temporary fighting position.

Performance Measures	GO	NO GO
1. Chose a position that took advantage of available cover and concealment.	___	___
2. Chose a position that allowed for observation and fire around the side of an object while concealing most of head and body.	___	___
3. Chose a position that allowed you to stay low when observing and firing, whenever possible.	___	___
4. Chose a position with a background that did not silhouette you against the surrounding environment.	___	___
5. Followed leader's directions after initial selection of a temporary battlefield position.	___	___

**Evaluation Guidance:** Score the soldier GO if all performance measures are passed. Score the soldier NO GO if any performance measure is failed. If the soldier scores NO GO, show him what was done wrong and how to do it correctly.

**References****Required**

FM 21-75

**Related**

---

**071-326-3002****React to Indirect Fire While Mounted**

**Conditions:** In a combat environment, given a combat-loaded tracked vehicle.

**Standards:** Reacted to indirect fire by moving the vehicle from the impact area, then continued the mission.

3-184

071-326-3002



---

**Performance Steps**

---

1. Give an order to close all hatches.
  2. Direct movement away from the impact area.
  3. Analyze the situation.
  4. Give a situation report.
  5. Continue the mission.
- 

**Evaluation Preparation:** Setup: At the test site, provide all equipment and materials listed in task conditions statement. Use only dummy ammunition for training purposes. Take soldiers on a simulated march.

**Brief Soldier:** Tell the soldiers they must react to a simulated indirect fire mortar or artillery fire while mounted in a tracked vehicle.

Performance Measures	GO	NO GO
1. Gave an order to close all hatches.	___	___
2. Directed movement away from the impact area.	___	___
3. Analyzed the situation.	___	___
4. Gave a situation report.	___	___
5. Continued the mission.	___	___

**Evaluation Guidance:** Score the soldier GO if all performance measures are passed. Score the soldier NO GO if any performance measure is failed. If the soldier fails any performance measure, show what was done wrong and how to do it correctly.

**References****Required****Related**

FM 7-7

FM 3-21.71

---

**071-326-5703****Construct Individual Fighting Positions**

**Conditions:** Given load-carrying equipment (LCE) with bayonet, scabbard, entrenching tool, poncho, and M16A1 rifle, a specific location and sector of fire, and logs construct an individual fighting position.

**Standards:** Constructed a hasty fighting position that gave frontal cover from enemy direct fire but allowed you to fire to the front and oblique.

Constructed a one-man fighting position with the following characteristics:

- Wide enough for you and your equipment.
- Armpit deep with frontal and overhead cover at least 18 inches deep.
- Had grenade sumps and a floor sloped toward the sumps.
- Allowed you to place fire on your assigned sector.

---

#### Performance Steps

---

**Note:** When you first move into battle, there may be little or no time to prepare a position.

1. Prepare a hasty fighting position.
  - a. Select a hasty fighting position that—
    - (1) Is behind whatever cover is available.
    - (2) Provides frontal protection.
    - (3) Allows you to shoot to the front and at an oblique angle.
    - (4) Is in a small depression or a hole that is at least half a meter (18 inches) deep.

**Note.** The term "hasty position" does not mean there is no digging.

- b. Improve your position with whatever time is available by digging or scraping out a prone shelter that will give you some protection (figure 071-326-5703-1).



Figure 071-326-5703-1. Hasty fighting position

- 
2. Prepare a one-man fighting position (figure 071-326-5703-2).
-

---

**Performance Steps**

---



**Figure 071-326-5703-2. One-man fighting position**

**Note.** This type of position allows flexibility in the use of cover. The hole only has to be long enough for you and your equipment. You must be able to shoot to both the front and oblique from behind frontal cover. It does not provide the security a two-man position does.

- a. Obtain position location and sector of fire from your leader.
- b. Put in sector-of-fire stakes.
- c. Partially clear a field of fire within your sector.
- d. Dig a hasty hole for minimum protection, being careful not to destroy natural camouflage around your position.
- e. Save grass clumps for use as camouflage later.

**Note.** At this stage of construction, you should be able to fight effectively from the position if there is a surprise attack.

- f. Dig in, shaping the hole to fit the natural cover available.

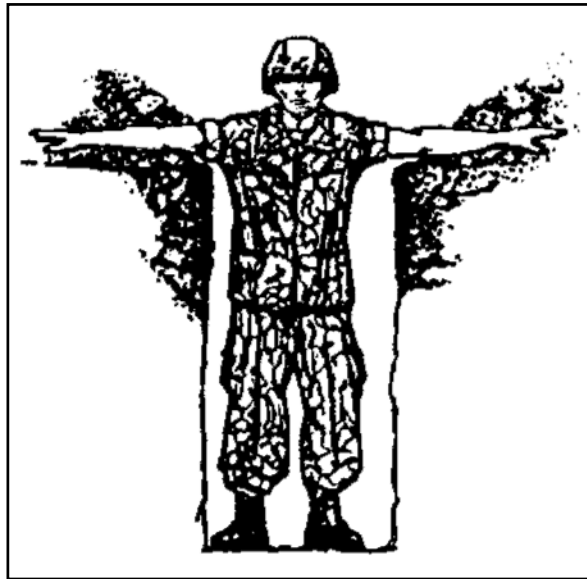
**Note.** Depending on the size and shape of the frontal cover, you may not be able to dig a rectangular hole.

- (1) Make the hole armpit deep (figure 071-326-5703-3).
-

---

Performance Steps

---



**Figure 071-326-5703-3. Fighting position armpit deep**

**Note.** Frontal cover is important so you can shoot without exposing your head to enemy fire. Ideally, you will have a natural parapet, such as a tree, mound, rock, or stump that will blend with the surrounding terrain available for frontal cover.

**(2)** Use the dirt from your hole to build a parapet that--

**(a)** Provides frontal cover with at least 45 centimeters (18 inches) of earth between you and the enemy if a natural parapet is not available.

**(b)** Is high enough to cover your head.

**(c)** Is far enough in front of the hole to allow for elbow rests and sector stakes.

**(3)** Modify your position on steep terrain by digging out firing ports at each end of the hole so the ground between the firing ports serves as frontal cover for the position (figure 071-326-5703-4).

---

---

Performance Steps

---



Figure 071-326-5703-4. Fighting position on slope

**Note.** On a steep slope, a soldier in a hole behind frontal cover cannot shoot attackers without being exposed to enemy fire.

---

---

**Performance Steps**

---

**g.** Save remaining dirt for use as flank, overhead, and rear cover later (figure 071-326-5703-5 and figure 071-326-5703-6).

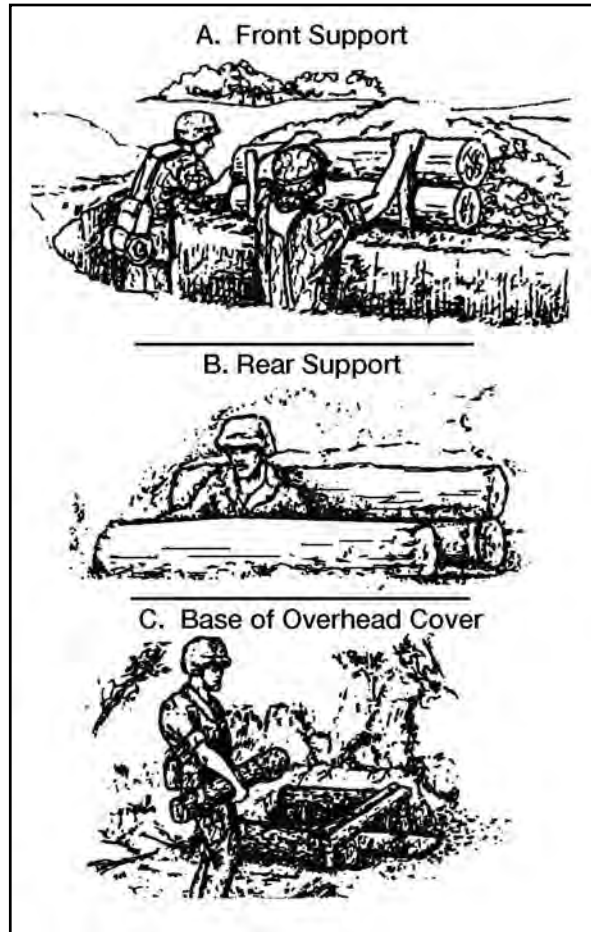


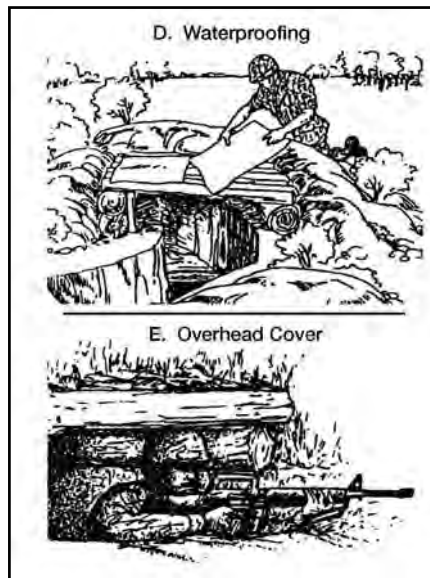
Figure 071-326-5703-5. Constructing overhead cover (1)

---

---

**Performance Steps**

---



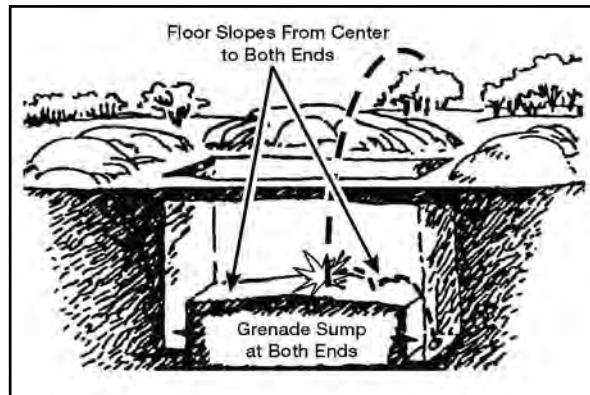
**Figure 071-326-5703-6. Constructing overhead cover (2)**

- h.** Dispose of excess dirt.
    - (1)** Carry dirt away from your position.
    - (2)** Camouflage excess dirt.
  - i.** Dig two trench-shaped grenade sumps (figure 071-326-5703-7).
-

---

**Performance Steps**

---



**Figure 071-326-5703-7. Two trench-shaped grenade sumps**

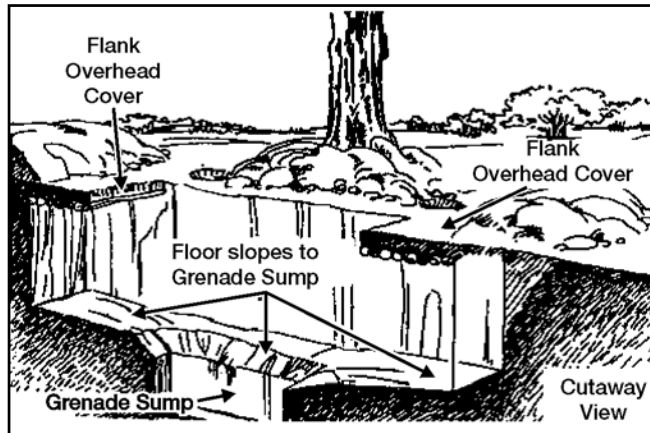
- (1) Place one at each end of the position.
  - (2) Make the trenches as wide as an entrenching tool blade, as deep as the entrenching tool, and as long as the position is wide.
    - j. Slope the floor toward the sumps (figure 071-326-5703-7).
- Note.** The slope should be steep enough so a grenade thrown into the position will roll into one of the sumps.
3. Complete clearing the field of fire (see Task 071-331-0852).
    - a. Clear only what is absolutely necessary.
    - b. Check the observation and field of fire from inside the position.
  4. Save any cut foliage, dirt, or grass clumps to camouflage your position.
  5. Construct the fighting position overhead cover that provides the best possible protection from airbursts while allowing you to fight from underneath it.
    - a. Use logs 10 to 15 centimeters (4 to 6 inches) thick for the supports, base, and top.
    - b. Construct front and rear supports that are the same height as the terrain.
    - c. Cover logs with at least 45 centimeters (18 inches) of dirt.
  6. Construct flank overhead cover when frontal overhead cover would significantly increase the silhouette of the position, making it vulnerable to detection (figure 071-326-5703-8).
-



---

**Performance Steps**

---



**Figure 071-326-5703-8. Flank overhead cover**

7. Camouflage your position using available materials (grass clumps, foliage) to make your position blend into surroundings.
8. Check the camouflage by moving 35 meters to the front; if you can spot it easily, you need more work on camouflage.

---

**Evaluation Preparation:**

*Setup:* Select an area of terrain with varying features such as fences, hedgerows, rocks, trees, and ravines.

*Brief Soldier:* Tell soldier the approximate location of enemy positions. Order the soldier to construct a hasty fighting position and an improved fighting position.

Performance Measures	GO	NO GO
1. Prepared a hasty fighting position that—	___	___
a. Was behind whatever cover was available.		
b. Provided frontal protection.		
c. Allowed you to shoot to the front and at an oblique angle.		
d. Was in a small depression or a hole at least half a meter (18 inches) deep.		
2. Prepared a one-man fighting position that—	___	___

Performance Measures	GO	NO GO
a. Had sector-of-fire stakes.		
b. Was dug in a shape that fits the natural cover available.		
c. Was armpit deep.		
d. Had a parapet that—		
(1) Provided frontal cover with at least 45 centimeters (18 inches) of earth between you and the enemy, if a natural parapet was not available.		
(2) Was high enough to cover your head.		
(3) Was far enough in front of the hole to allow for elbow rests and sector stakes.		
(4) Was modified on steep terrain by digging out firing ports at each end of the hole so the ground between the firing ports served as frontal cover for the position.		
3. Disposed of excess dirt.	___	___
a. Carried dirt away from your position.		
b. Camouflaged excess dirt.		
4. Dug two trench-shaped grenade sumps.	___	___
a. Placed one at each end of the position.		
b. Made the trenches as wide as an entrenching tool blade, as deep as the entrenching tool, and as long as the position was wide.		
5. Sloped the floor toward the sumps.	___	___
6. Completed clearing the field of fire:	___	___
a. Cleared only what was absolutely necessary.		
b. Checked the observation and field of fire from inside the position.		
7. Constructed the fighting position overhead cover that provided the best possible protection from airbursts while allowing you to fight from underneath it.	___	___
a. Used 4- to 6-inch logs for supports, base, and top of cover.		
b. Covered logs with at least 18 inches of dirt.		

Performance Measures	GO	NO GO
8. Constructed flank overhead cover when frontal overhead cover would significantly increase the silhouette of the position, making it vulnerable to detection.	—	—
9. Camouflaged position using available materials so it was not visible from 35 meters to the front.	—	—

**Evaluation Guidance:** Score the soldier GO if all performance measures are passed. Score the soldier NO GO if any performance measure is failed. If the soldier scores NO GO, show him what was done wrong and how to do it correctly.

#### References

##### Required

FM 7-8

##### Related

---

## 071-331-0815

### Practice Noise, Light, and Litter Discipline

**Conditions:** You are a member of an element conducting a tactical mission.

**Standards:** Ensured that noise was kept at a minimum; no light was visible to the enemy; the area was free of litter and other evidence of the unit's presence.

---

#### Performance Steps

1. Comply with noise discipline.
    - a. Avoid all unnecessary vehicular and foot movement.
    - b. Secure (with tape or other materials) metal parts (for example, weapon slings, canteen cups, identification tags) to prevent them from making noise during movement.
    - c. Do not restrict moving parts of weapons if doing so prevents their operation.
    - d. Talk only to conduct or explain operations.
    - e. Use radios only when necessary, keeping the volume low so only you can hear it.
  2. Comply with light discipline.
    - a. Do not smoke except when concealed from enemy view.
-

---

**Performance Steps**

---

**Note.** Smoking at night should be restricted, as the enemy can see and smell the smoke.

- b.** Conceal flashlights and other light sources so the light is filtered (for example, under a poncho).
  - c.** Cover anything that reflects light (for example, metal surfaces, vehicles, glass).
  - d.** Use all available natural concealment.
  - e.** Camouflage all vehicles and equipment.
- 3.** Comply with litter discipline.
- a.** Take all litter (empty food containers, empty ammunition cans or boxes, old camouflage) to established collection points.
  - b.** Carry all litter with you until you can dispose of it without leaving any trace.
- 

**Evaluation Preparation:**

*Setup:* Schedule this exercise in conjunction with field maneuvers or field exercises or use defensive positions.

<b>Performance Measures</b>	<b>GO</b>	<b>NO GO</b>
<b>1.</b> Complied with noise discipline.	___	___
<b>a.</b> Avoided all unnecessary vehicular and foot movement.		
<b>b.</b> Secured metal parts, preventing them from making noise during movement.		
<b>c.</b> Did not restrict moving parts of secured weapons, preventing operation.		
<b>d.</b> Talked only to conduct or explain operations.		
<b>e.</b> Used radios only when necessary, kept the volume low so only you could hear it.		
<b>2.</b> Complied with light discipline.	___	___
<b>a.</b> Smoked only when concealed from enemy view.		
<b>b.</b> Concealed flashlights and other light sources so the light was filtered.		
<b>c.</b> Covered anything that reflected light.		
<b>d.</b> Used all available natural concealment.		
<b>e.</b> Camouflaged all vehicles and equipment.		

Performance Measures	GO	NO GO
3. Complied with litter discipline.	___	___
a. Took all litter to established collection points.		
b. Carried all litter until it could be disposed of without leaving any trace.		

**Evaluation Guidance:** Score the soldier GO if all performance measures are passed. Score the soldier NO GO if any performance measure is failed. If the soldier scores NO GO, show him what was done wrong and how to do it correctly.

**References**

**Required**

FM 7-8

---

**071-331-1004**

**Perform Duty as a Guard**

**Conditions:** Assigned a guard post, post-specific equipment, and special orders.

**Standards:** Performed duty according to general orders, special orders, and local implementing SOPs.

---

**Performance Steps**

1. Receive order changes, if any.
  2. Walk posts or assume the prescribed position, carrying the weapon in prescribed manner.
  3. Salute officers when performing guard duty on posts that do not require challenging.
  4. Challenge personnel as specified by special orders. Challenge position is port arms or raised pistol.
    - a. Challenge one person by assuming challenge position approximately 30 steps from individual and stating "HALT." Once the individual has halted, call "WHO IS THERE"? The guard may change position to best determine if the individual should be passed, denied access, or apprehended and turned over to the commander of the relief. Take the appropriate action based on identification of the person.
-

---

**Performance Steps**

---

**b.** Challenge a group in the same manner. Allow only one person to approach for identification. If persons are in a vehicle allow only one person to approach for identification.

**c.** Challenge multiple groups or individuals. Advance personnel to be recognized in the same manner; only one at a time and in order of seniority.

**Note.** During a duty tour, a guard is required to execute orders ONLY from the commanding officer, the field officer of the day, the officer of the day and officers of the guard. A guard surrenders his weapon only to, and upon orders from, someone from whom he lawfully receives orders while on post.

**5.** Pass changes to orders to relief.

---

**Evaluation Preparation:**

*Setup:* At the test site, provide the soldier with a post, post-specific equipment, and special orders. Provide a group to approach the post.

*Brief Soldier:* Tell the soldier to read the special orders and assume the sentry duties of the post.

Performance Measures	GO	NO GO
1. Received order changes.	___	___
2. Saluted officer when required. (Post does not require challenging.)	___	___
3. Challenged individual.	___	___
4. Challenged group.	___	___
5. Passed the order changes to the relief.	___	___

**Evaluation Guidance:** Score the soldier GO if all performance measures are passed. Score the soldier NO GO if any performance measure is failed. If the soldier scores NO GO, show him what was done wrong and how to do it correctly.

**References****Required****Related**

FM 22-6

---

## 071-410-0002

### React to Direct Fire While Mounted

**Conditions:** In a combat environment, given tracked vehicle and a requirement to react to direct fire.

**Standards:** The vehicle returned fire and took appropriate action after analysis of the situation based on an order received from the chain of command.

---

#### Performance Steps

**Note.** If the vehicle is in formation, it moves according to company tactical SOP. If not, it should use evasive action as appropriate to avoid threat fire while performing step 2.

1. Direct return fire to destroy or suppress threat fire.

**Note.** If threat is destroyed, continue the present mission.

2. Direct the driver to a hull-down position.

**Note.** Direct dismount, if appropriate, to establish a base of fire.

3. Analyze the situation.

4. Give a situation report.

5. Take defensive or offensive action based on orders from chain of command.

---

#### Evaluation Preparation:

**Setup:** At the test site, provide all equipment and materials listed in the task conditions. Use only blank ammunition for training. Take the soldiers on a simulated march.

**Brief Soldier:** Tell the soldiers they must react to simulated direct fire while mounted in a tracked vehicle.

Performance Measures	GO	NO GO
1. Directed return fire to destroy or suppress threat fire.	___	___
2. Directed the driver to a hull-down position.	___	___
3. Analyzed the situation.	___	___
4. Gave a situation report.	___	___
5. Took defensive or offensive action based on orders from the chain of command.	___	___

**Evaluation Guidance:** Score the soldier GO if all performance measures are passed. Score the soldier NO GO if any performance measure is failed. If the soldier fails any performance measure, show what was done wrong and how to do it correctly.

**References**

**Required**

**Related**

FM 7-7

FM 3-21.71

---

**071-710-0006**

**Plan Use of Night Vision Devices**

**Conditions:** In a combat environment, given a platoon with a requirement to plan for the use of night vision devices.

**Standards:** Made a plan that designated who would operate night vision devices and what, where, and when they would do so.

---

**Performance Steps**

1. Analyze the platoon's mission.
  2. Analyze the terrain.
  3. Determine what operational (working properly) night vision devices the platoon has on hand (assets available).
  4. Consider the operating range of the platoon's reconnaissance, surveillance, and target acquisition (RSTA) devices as well as how badly inclement weather could limit those ranges.
  5. If the platoon has Bradley fighting vehicles (BFVs) or similar vehicles, develop and include a plan to rotate observation responsibilities between vehicle crew members.
  6. If the platoon has BFV(s) or similar vehicles, include a plan for recharging the vehicle and equipment batteries during limited visibility conditions.
  7. Include in the plan the mounting of the night weapon sights on the various weapon systems. State how the platoon will use them in both surveillance and target acquisition role.
  8. Discuss how the platoon will coordinate with other units to ensure overlapping sectors of observation (if applicable).
  9. Establish a procedure for implementing the platoon OPLAN.
  10. Ensure the OPLAN is disseminated.
-



**Evaluation Preparation:**

*Setup:* Provide the leader with equipment and RSTA assets.

*Brief Soldier:* Tell the soldier that soldiers using night vision devices lose their visual efficiency after about 30 minutes. Therefore, to avoid eye fatigue, the OPLAN should require that the soldier using the equipment rest after each 30-minute shift, and after 1 ½ to 2 hours, observation duty rotates to another soldier.

<b>Performance Measures</b>	<b>GO</b>	<b>NO GO</b>
1. Analyzed the platoon's mission.	___	___
2. Analyzed the terrain.	___	___
3. Determined what operational (properly working) night vision devices the platoon had on hand.	___	___
4. Considered the operating range of the platoon's RSTA devices as well as how badly inclement weather could have limited those ranges.	___	___
5. If the platoon had BFVs or similar vehicles, developed and included a plan to rotate observation responsibilities between vehicle crew members.	___	___
6. If the platoon had BFVs or similar vehicles, included a plan for recharging the vehicle and equipment batteries during limited visibility conditions.	___	___
7. Included in the plan the mounting of the night weapon sights on the various weapon systems. Stated how the platoon would use them in both surveillance and target acquisition roles.	___	___
8. Discussed how the platoon would coordinate with other units to ensure overlapping sectors of observation (if applicable).	___	___
9. Established a procedure for implementing the platoon OPLAN.	___	___
10. Ensured the OPLAN was disseminated.	___	___

**Evaluation Guidance:** Score the soldier GO if all performance measures are passed. Score the soldier NO GO if any performance measure is failed. If the soldier fails any performance measures, show what was done wrong and how to do it correctly.

**References**

**Required**

**Related**

FM 3-21.71

---

**093-401-5040**

**React to Unexploded Ordnance Hazards**

**Conditions:** In a field environment, given an item(s) of simulated unexploded ordnance (UXO), marking materials, and a UXO Spot Report format.

**Standards:** Identified UXO by type and subgroup; recognized associated hazards; took immediate action to prevent death, injury, or damage to materiel; reported the UXO hazard using the UXO Spot Report format.

---

**Performance Steps**

1. Recognize the UXO hazard.

**DANGER**

**Never approach a UXO once it has been identified. Approaching UXO may cause them to explode.**

**DANGER**

**Never strike, jar, or touch a UXO. Do not move or remove anything on or near a suspect UXO. UXO can be extremely sensitive and can cause serious injury or death if disturbed in any way.**

**DANGER**

**Many types of UXO may contain an incendiary (fire producing), chemical, biological, or radiological hazard in addition to explosives.**

---

**Performance Steps**

---

**DANGER**

**Do not make radio transmissions within 100 meters of a UXO. Some types of UXO are sensitive to electromagnetic radiation (EMR) and may explode.**

a. Identify the four types and subgroups of UXO.

(1) Dropped.

(a) Bombs (figure 093-401-5040-1):

- Vary from 3 to 6 feet in length.
- Vary in diameter from 5 to 36 inches.
- Often have a sloped or "bullet" shaped nose, fins and/or a parachute on the back.
- May contain high explosive, incendiary, or chemical fillers.

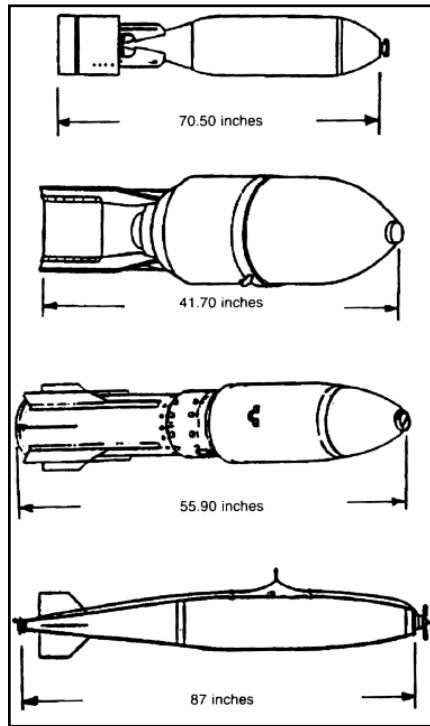
(b) Dispensers (figure 093-401-5040-2):

- Contain numerous submunitions or bomblets.
  - Most have the same characteristics of bombs.
  - May be found intact or partially open.
-

---

**Performance Steps**

---



**Figure 093-401-5040-1. Bombs**

---

---

Performance Steps

---

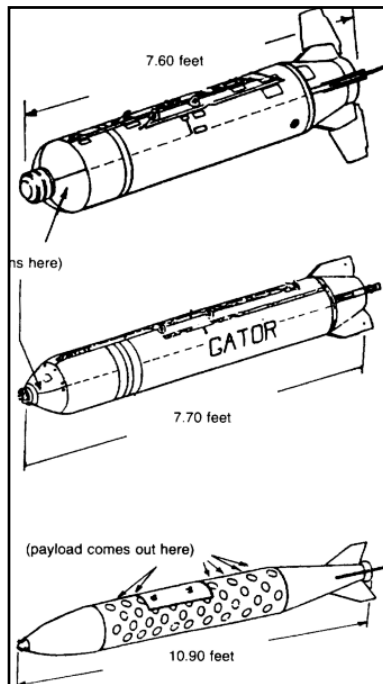


Figure 093-401-5040-2. Dispensers

(c) Submunitions (figures 093-401-5040-3a through 093-401-5040-3e):

**DANGER**

When a submunition is identified, leave the area by the same path you entered. There may be many more submunitions in the same area. Small size does not diminish the danger of submunitions. The smallest can easily injure or kill.

- May contain the same hazards of bombs (explosive, chemical, biological, radiological, incendiary).
- Are designed to be scattered over a wide area.
- Come in many shapes and sizes; may or may not be

---

**Performance Steps**

---

- "bullet" shaped.
- May look like balls, wedges, or cylinders.
- May have fins, ribbons, parachutes, or trip wires.

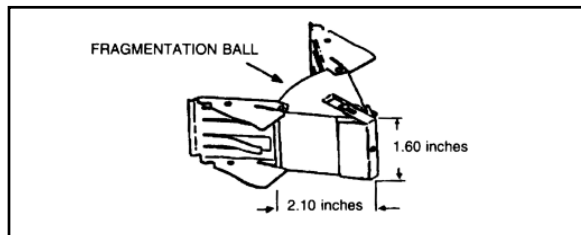


Figure 093-401-5040-3a.

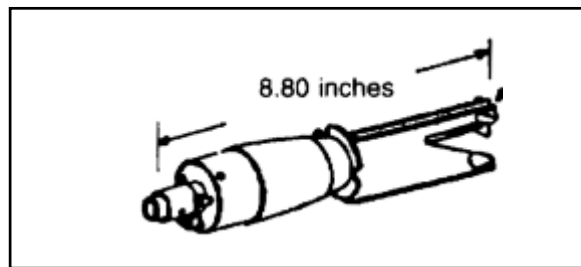


Figure 093-401-5040-3b.

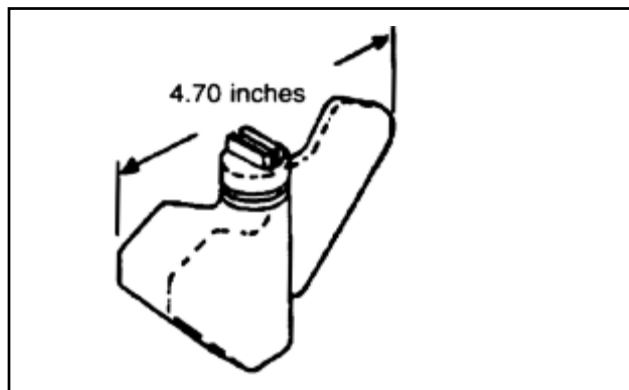


Figure 093-401-5040-3c.

---

---

**Performance Steps**

---

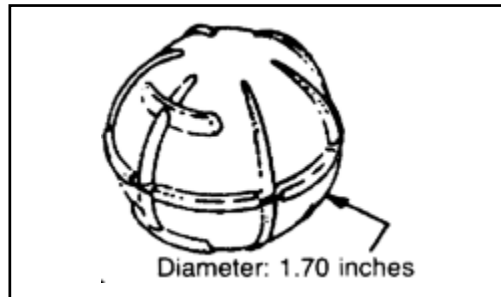


Figure 093-401-5040-3d

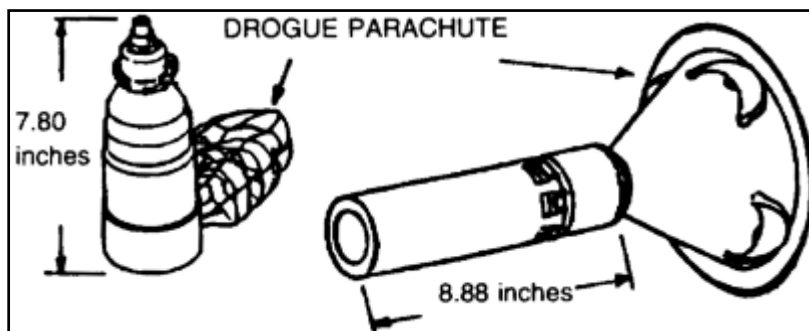


Figure 093-401-5040-3e.

**(2) Projected.**

**(a) Projectiles (figures 093-401-5040-4a through 093-401-5040-4b):**

- Include munitions from large machine guns, artillery howitzers, and naval guns.
  - Range in size from 20mm up to 16 inches in diameter; 10 to 30 inches in length.
  - Most resemble a "bullet" shape.
  - Can contain explosive, chemical, biological, radiological, and/or incendiary hazards.
-

---

Performance Steps

---

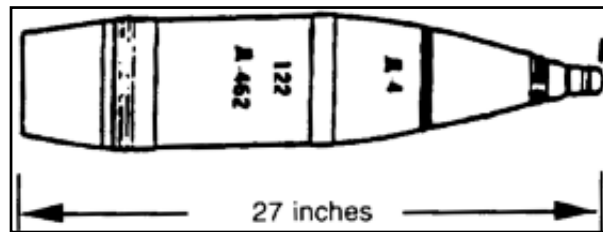


Figure 093-401-5040-4a.

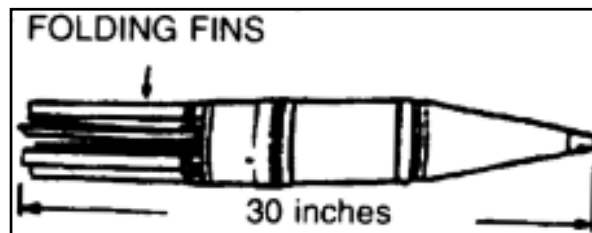


Figure 093-401-5040-4b.

- 5b):
- Most have fins and a "bullet" shape.
  - Range in size from 60mm to 120mm in diameter; 12 inches to 36 inches in length.
  - Can contain explosive, chemical, or incendiary hazards.

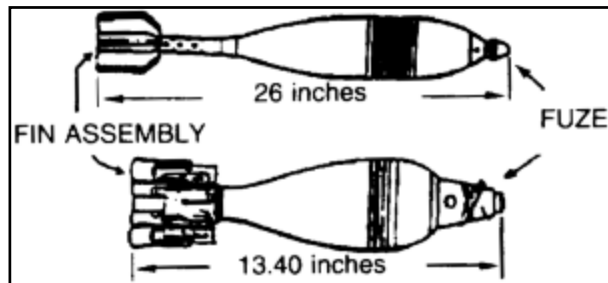


Figure 093-401-5040-5a.

---



---

Performance Steps

---

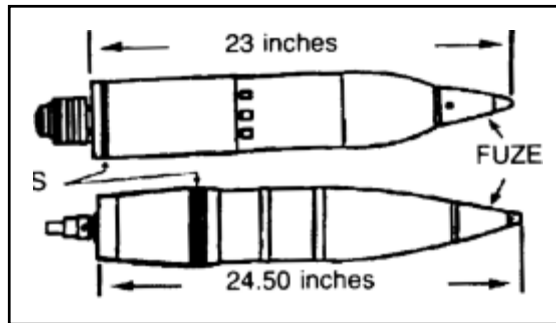


Figure 093-401-5040-5b.

6c): (c) Rockets (figures 093-401-5040-6a through 093-401-5040-

- May or may not have fins.
- Have some sort of rocket motor vents in back.
- Range in length from 24 inches to several feet.
- Can contain explosive, chemical, or incendiary hazards.

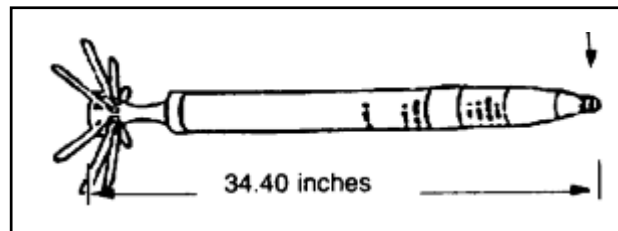


Figure 093-401-5040-6a.

---

---

Performance Steps

---

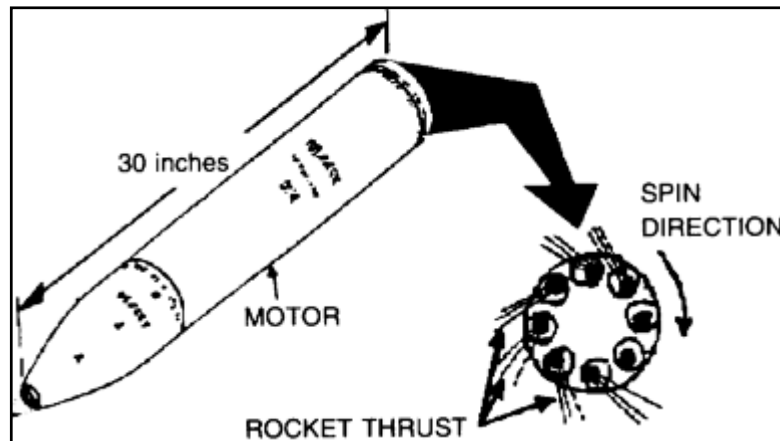


Figure 093-401-5040-6b.

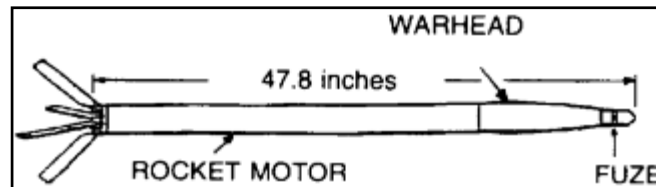


Figure 093-401-5040-6c.

(d) Guided Missiles (figure 093-401-5040-7a through 093-401-5040-7b):

- Most have fins.
  - Some have wires in the end for guidance.
  - Very similar to rockets.
  - Can contain explosive or incendiary hazards.
-

---

Performance Steps

---

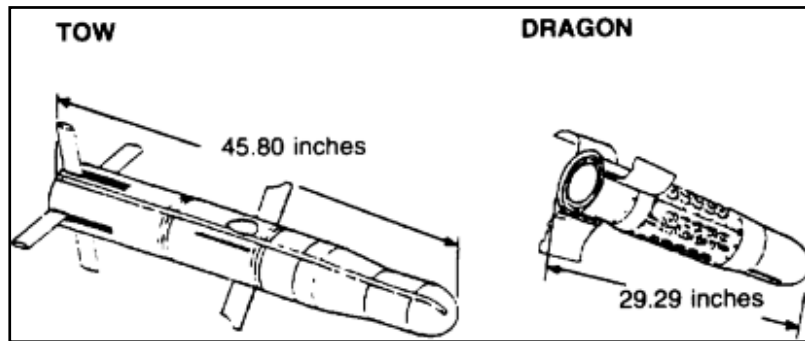


Figure 093-401-5040-7a.

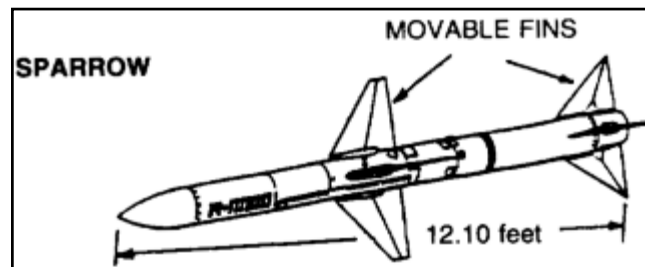


Figure 093-401-5040-7b.

(e) Rifle Grenades (figures 093-401-5040-8a through 093-401-5040-8b):

- Designed to be fired from rifles or shoulder fired launchers.
  - Resemble rockets but are smaller.
  - Can contain explosive or incendiary hazards.
-

---

**Performance Steps**

---

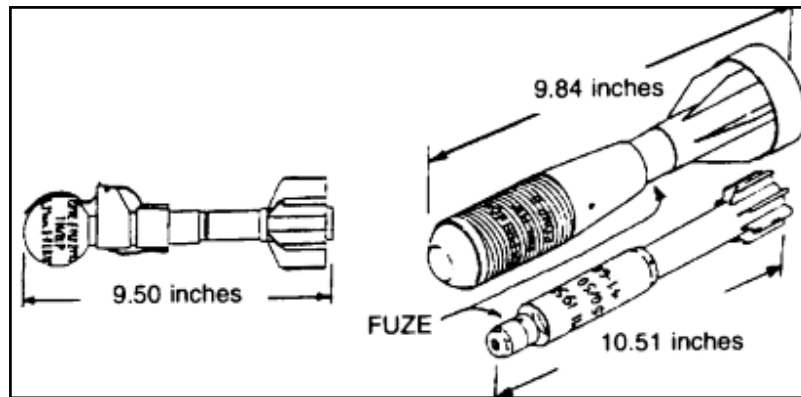


Figure 093-401-5040-8a.

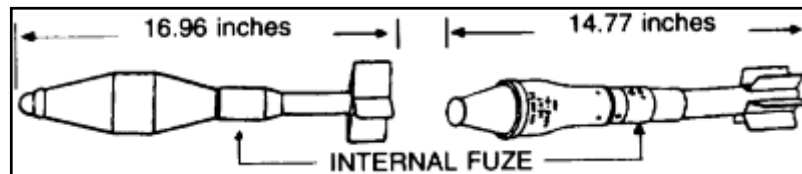


Figure 093-401-5040-8b.

- (3) Thrown (figures 093-401-5040-9a through 093-401-5040-9b):
- Includes all types of grenades, including simulators.
  - Most are round or cylindrical.
  - Are small enough to be thrown by a person.
  - Can contain explosive or incendiary hazards.
  - Dud simulators require the same safety procedures as other ordnance.
-

---

Performance Steps

---

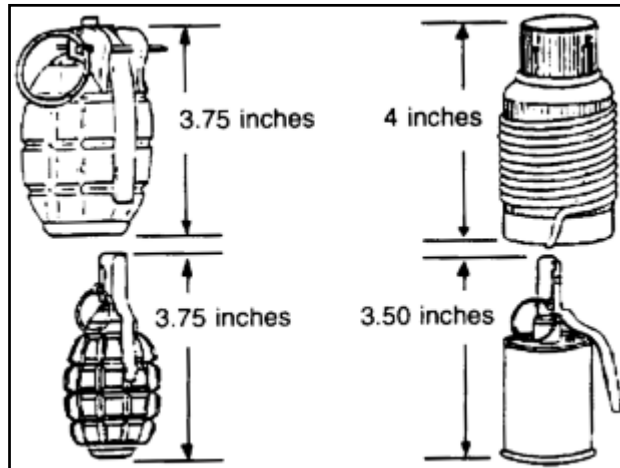


Figure 093-401-5040-9a.

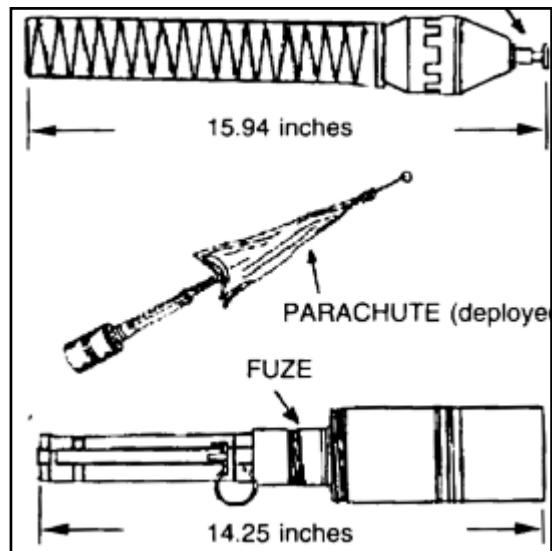


Figure 093-401-5040-9b.

---

Performance Steps

---

**DANGER**

Never approach a grenade that was thrown and did not detonate, even if you threw it. Do not move, jar, or disturb—the fuse may function at any time.

Never pick up, move, or disturb a found grenade, even if spoon or safety pin are attached. The grenade may be booby-trapped and explode when disturbed.

- (4) Placed (figures 093-401-5040-10a through 093-401-5040-10b):
- Includes all land or sea mines.
  - Range in size from 2 inches in diameter to several feet in length.
  - Have a variety of fuse types; pressure plates, tilt rods, trip wires, electronic sensors, or command detonated.
  - Can contain explosive, incendiary, or chemical hazards.

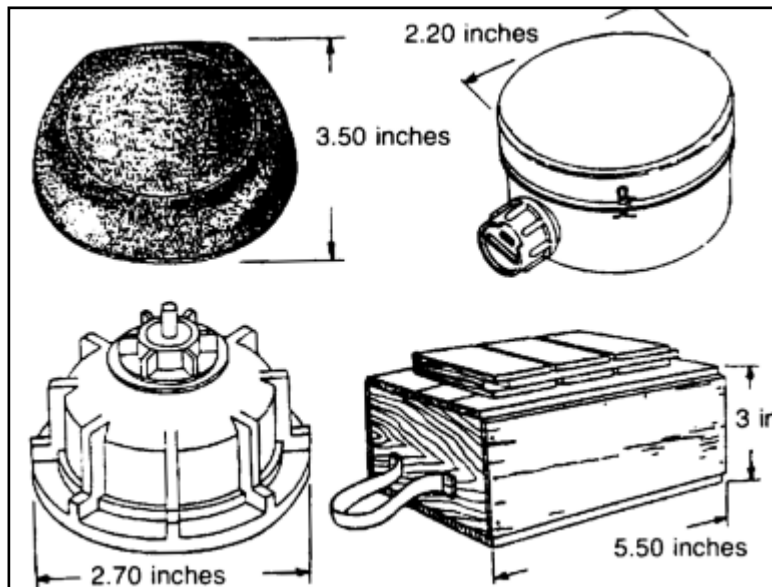


Figure 093-401-5040-10a.

---

Performance Steps

---

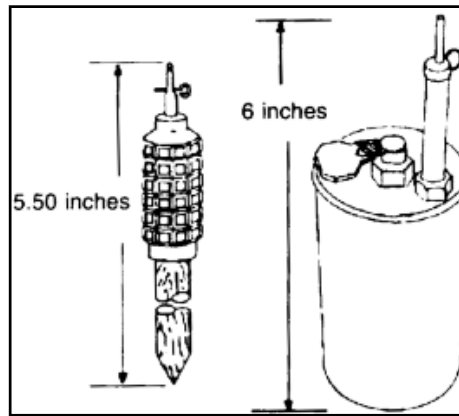


Figure 093-401-5040-10b.

**DANGER**

Consider all mines to be booby-trapped or to have anti-disturbance fusing. Never attempt to uncover or remove placed ordnance.

---

**2. React to the UXO hazard.**

**a.** Do not touch or disturb the UXO or any wires, parachutes, or anything attached or surrounding the UXO. Do not move closer to UXO.

**b.** If any peculiar smells, liquids, or dead animals are present, chemical or biological agents may be present; don mask and MOPP gear immediately.

**c.** Mark location with material such as white engineer tape, marking ribbon, clothing, or sign. Place marker above ground at waist level if possible. Take note of physical terrain features of location and route back to UXO so EOD team can return and dispose of UXO.

**d.** Evacuate personnel and equipment from area surrounding the UXO:

**(1)** Bombs, dispensers, large projected munitions (90-mm diameter and larger)—evacuate a 360-degree perimeter at least 600 meters.

**(2)** Submunitions, placed, thrown, small projected munitions (smaller than 90-mm diameter)—evacuate a 360-degree perimeter at least 300 meters.

**e.** If personnel or equipment cannot be evacuated, seek as much frontal and overhead cover as possible.

**f.** If UXO is suspected to have a chemical agent, ensure all personnel stay upwind of item and are in full MOPP.

**3. Report the UXO hazard.**

**a.** Report UXO hazard to your chain of command. You or your chain of command should request Explosive Ordnance Disposal (EOD) support using the nine-line UXO Spot Report:

**(1)** Date and time of the fall, impact, or finding of the UXO item(s).

**(2)** The exact location of item(s) including grid coordinate, landmarks, reference points, or street addresses.

**(3)** The name and organization of person reporting the incident including call sign or phone number.

**(4)** Identify UXO by type (Dropped, Projected, Thrown, Placed) and subgroup.

**(5)** Any NBC contamination present.

**(6)** What resources are threatened?

**(7)** How the UXO has affected unit mission.

**(8)** The safety measures that have been taken including the evacuation distances that have been accomplished.

---



---

(9) The requested priority for receiving EOD support (Immediate, Indirect, Minor, No Threat)

b. Be prepared to provide a guide to the EOD team.

---

**Evaluation Preparation:**

*Setup:* Do not evaluate this task using live UXO. Utilize training items from your installation Training Aids Support Center. Preliminary instruction of this task can be obtained by requesting support from nearest Army EOD company. Evaluate this task during any training exercise where UXO is likely to be encountered. Place UXO training aid near personnel, facilities, or equipment within the soldier's area of responsibility. Soldier should identify UXO from at least 5-10 meters away or through the use of binoculars.

*Brief Soldier:* Tell the soldier he will be evaluated on his ability to properly recognize, react to, and report a UXO hazard. The soldier will identify the UXO by type and subgroup, take appropriate actions to react to the hazards, and report the hazard using the nine-line UXO Spot Report format.

<b>Performance Measures</b>	<b>GO</b>	<b>NO GO</b>
1. Identified UXO by type and subgroup.	___	___
2. Reacted to UXO hazard, observing all applicable safety precautions.	___	___
3. Marked the UXO.	___	___
4. Determined appropriate evacuation distance (Large item: 600m; Small item: 300m).	___	___
5. Reported UXO hazard using the nine-line UXO Spot Report.	___	___

**Evaluation Guidance:** Score the soldier GO if all performance measures are performed correctly. Score the soldier NO GO if any performance measure is not performed correctly. If the soldier scores NO GO, show him what was done wrong and how to do it correctly.

**References**

**Required**

FM 21-16

GTA 9-12-1

**Related**

---

## 551-88M-0005

### Operate a Vehicle in a Convoy

**Conditions:** Given a briefing by the convoy commander, a vehicle with before-operation maintenance performed, and a flashlight (night convoy), weapon, and LCE/Kevlar. Task must be performed under the march unit commander's supervision.

**Standards:** Operated the vehicle according to specific instructions from the convoy or march unit commander. Correctly reacted to, and relayed, all hand signals, and followed all highway warning and regulatory signs according to FM 21-305.

---

#### Performance Steps

---

1. Start the engine, after receiving the signal or the order from the march unit commander.
    - a. Start the engine.
    - b. Apply the parking brake, if appropriate.
    - c. Adjust the seats so you can comfortably manipulate the vehicle controls.
    - d. Adjust driving mirrors to obtain a clear view on both sides and to the rear of the vehicle.
    - e. Fasten your seat belts, if appropriate.
    - f. Place the transmission shift lever in neutral (N) or park (P), as appropriate.
    - g. Place the differential lock/unlock control to the unlock position, if appropriate.
    - h. Turn off all accessories.
    - i. Disengage the engine retarder system, if appropriate.
    - j. Push in the clutch pedal, if appropriate.
    - k. Turn on the engine run switch, if appropriate.
    - l. Engage the start button or ignition switch, as appropriate, while depressing the accelerator pedal.
    - m. Release the start button or ignition switch, as appropriate.
- Note.** If the engine fails to start, wait two minutes before trying again (diesel engines only).
- n. Press on the accelerator as necessary to maintain idle speed and observe the oil pressure gauge.
  - o. Observe all instruments and warning lights for proper indication.
-

---

**Performance Steps**

---

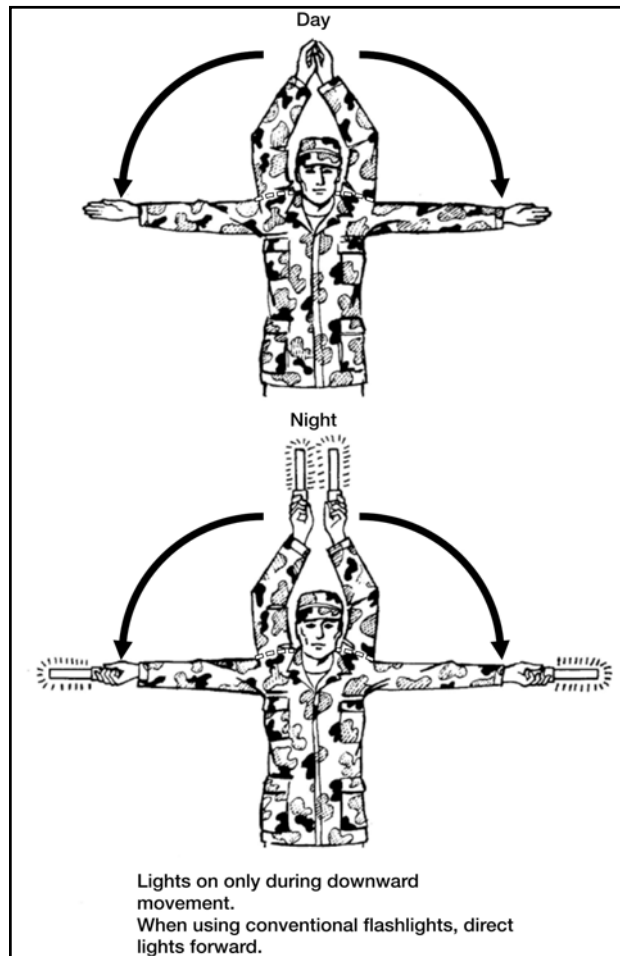
- 2.** Set the vehicle in motion, after receiving the signal or the order to move out.
    - a.** Check all gauges to make sure the vehicle is ready for operation.
    - b.** Turn on the light switch at night, as required.
    - c.** Apply the brake.
    - d.** Release the parking brake, if appropriate.
    - e.** Place the transmission shift selector lever in drive (D), as appropriate.
    - f.** Place the transmission shift lever in low/first gear, as appropriate.
    - g.** Release the clutch pedal until it takes hold, if appropriate.
    - h.** Check for approaching traffic.
    - i.** Signal to indicate the direction of movement.
    - j.** Remove your foot from the brake pedal.
    - k.** Depress the accelerator while releasing the clutch pedal, as appropriate.
    - l.** Continue shifting until reaching the desired road speed, as appropriate.
  - 3.** Operate the vehicle at the prescribed speed and maintain proper interval between vehicles.
    - a.** Maintain a minimum of a 5-minute gap between march units on the open road.
    - b.** Maintain a minimum of 10 minutes between serials on the road.
    - c.** Maintain the maximum speed for the segments of the road.
-

---

**Performance Steps**

---

d. Adjust speed interval and position according to the signals in figures 551-88M-0005-1, 551-88M-0005-2, 551-88M-0005-3, and 551-88M-0005-4.



**Figure 551-88M-0005-1. Extend (Open Up)**

---

Performance Steps

---

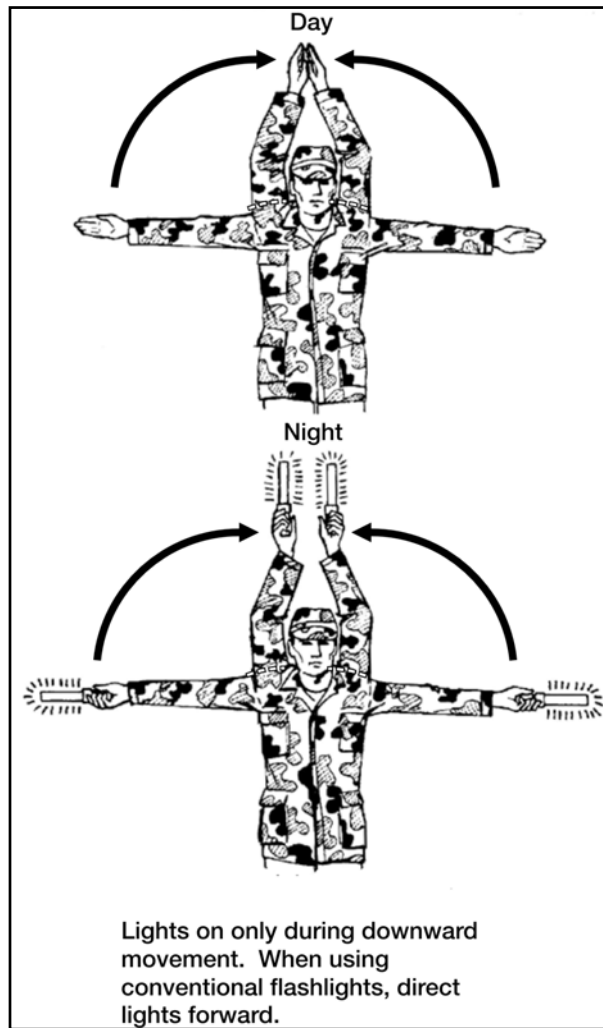


Figure 551-88M-0005-2. Close up

- e. Relay either of the above signals received from the march unit commander to the driver behind you.
-

---

Performance Steps

---

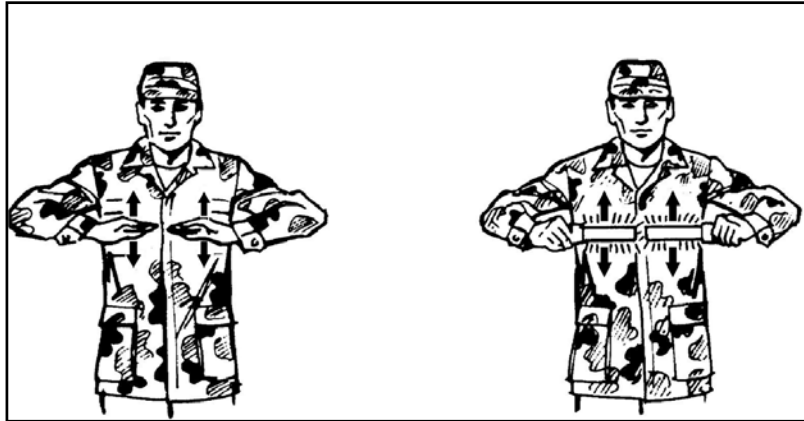


Figure 551-88M-0005-3. Slow Down

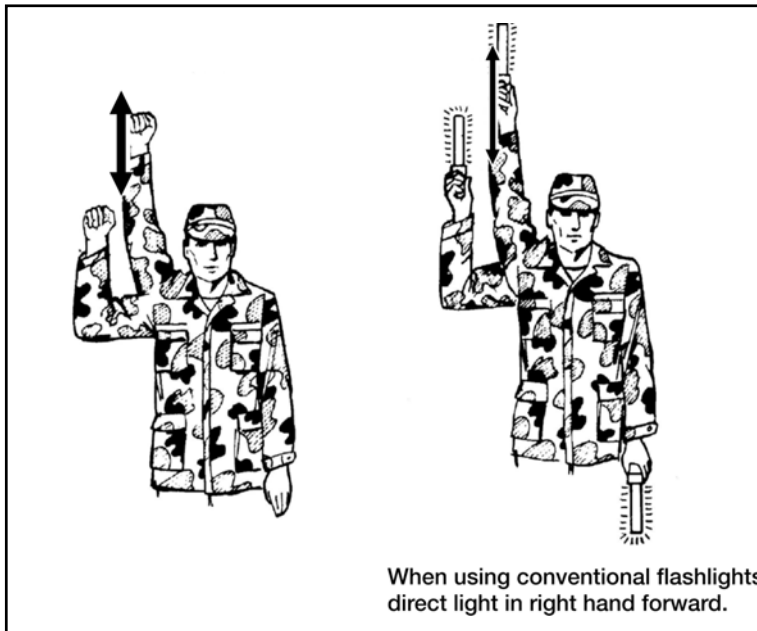


Figure 551-88M-0005-4. Increase Speed

---

---

**Performance Steps**

---

4. Stop the vehicle at the rest site.
    - a. Place the transmission ratio selector lever in neutral (N) or park (P), as appropriate.
    - b. Set the parking brake, if applicable.
    - c. Shut down the engine.
  5. Perform during-operation PMCS.
    - a. Before inspection, study the applicable TM. Pay particular attention to the section on PMCS.
    - b. Begin inspection at the first during-operation maintenance check listed on the PMCS chart.
    - c. Inspect in an orderly sequence, as described in the applicable TM, to save motion and eliminate the possibility of missing an important item.
    - d. Note deficiencies as you find them without trying to remember all of them.
    - e. Complete the inspection when you return to the starting point.
  6. Resume vehicle operations (steps 1 through 5).
  7. Park vehicles in a line at the convoy destination assembly area.
    - a. Place the transmission in neutral (N) or park (P), as appropriate.
    - b. Set parking brake, if appropriate.
    - c. Shut down the engine.
- 

**Evaluation Preparation:**

*Setup:* Set up the convoy with six vehicles at the starting point. Select a route for the convoy that will not interfere with the regular traffic. Use an NCO trained in convoy procedures to act as the convoy commander. Have the convoy commander brief the soldier on convoy operations.

*Brief Soldier:* Tell the soldier to follow the instructions given in the convoy commander's briefing.

Performance Measures	GO	NO GO
1. Started the engine.	___	___
2. Set the vehicle in motion.	___	___
3. Operated the vehicle at the prescribed speed and maintained the proper interval between vehicles.	___	___
4. Responded to hand signals given.	___	___

Performance Measures	GO	NO GO
5. Relayed the hand signals.	___	___
6. Stopped the vehicle at the rest area.	___	___
7. Performed during-operation PMCS.	___	___
8. Resumed vehicle operations.	___	___
9. Parked in the destination assembly area.	___	___

**Evaluation Guidance:** Score the soldier GO if all performance measures are passed. Score the soldier NO GO if any performance measure is failed. If the soldier scores NO GO, show him what was done wrong and how to do it correctly.

#### References

##### Required

FM 21-305

FM 55-30

##### Related

DA Pam 738-750

### SUBJECT AREA 5: NAVIGATE

## 071-329-1006

### Navigate from One Point on the Ground to Another Point While Dismounted

**Conditions:** Given a standard topographic map of the area, scale 1:50,000, a coordinate scale and protractor, a compass, and writing materials.

**Note.** See appendix C in this manual for related skills and knowledge supporting performance of this task.

**Standards:** Moved on foot to designated points at a rate of 3,000 meters per hour.

#### Performance Steps

1. Determine your pace count.

a. When traveling on foot, measure distance by counting paces. The average soldier uses 116 paces to travel 100 meters. Check your pace length by practicing on a known 100-meter distance, like a football field plus one end zone, which is 110 yards (about 100 meters).



---

**Performance Steps**

---

**b.** When traveling cross-country as in the field, you use more paces to travel 100 meters, usually about 148 instead of 116. This is because you are not traveling over level ground, and must use more paces to make up for movement up and down hills. Pace yourself over at least 600 meters of crisscrossing terrain to learn how many paces it takes you to travel an average 100 meters over such terrain.

**c.** Be sure you know how many paces it takes you to walk 100 meters on both level and crisscrossing terrain.

**(1)** The problem in pacing is maintaining a straight line. At night, you will tend to walk in a clockwise circle if you do not use a compass. In daylight, you should use aiming points and a compass. Also, remember to figure only the straight-line distance when you have to walk around an obstacle.

**(2)** Another problem is keeping count of paces taken. One way is to use pebbles. For instance, suppose you want to pace off one kilometer. (A kilometer is 1,000 meters or the distance between two of the black grid lines on the map.) Put 10 pebbles in your right pocket. When you go 100 meters, move one pebble to your left pocket and start your count over. When all 10 pebbles had been moved to your left pocket, you have traveled one kilometer. Or, tie knots in a string, one knot per 100 meters.

**d.** Sample problem: You are to move 715 meters, and your pace count for 100 meters is 116 paces.

**(1)** Using the pebble methods, you will need seven pebbles. This will take you 700 meters. But what about the other 15 meters?

**(2)** To determine how many paces it will take to go the remaining 15 meters, multiply 15 meters by your pace count ( $116 - 15 \times 116 = 1,740$ ). Mark out the last two numbers (40). The remainder (17) is how many paces it will take to go 15 meters.

**(3)** So you would go 715 meters using the pebble method by pacing off 116 paces per 100 meters until all seven pebbles are used, then go an additional 17 paces to arrive at 715 meters.

**2.** Navigate from one point to another using terrain association.

**a.** This technique uses terrain or man-made features to serve as landmarks or checkpoints for maintaining direction of movement. It can be used anywhere, day or night, as long as there are distinguishable terrain features. You use terrain association when moving from the unit area to the motor pool. You walk down the road or sidewalk using intersections or buildings to steer or turn on (landmarks or checkpoints). In the field, with few roads and buildings, use terrain features for your axis and checkpoints.

---

---

**Performance Steps**

---

b. In using association, you locate first your position on the map then your destination or objective. It will seldom be the best way to travel. For example, look at figure 071-329-1006-1. Assume that you are to move from point A to point B. You see that a straight line could cause you to climb several small ridges and valleys (the "Xs" on figure 071-329-1006-1).

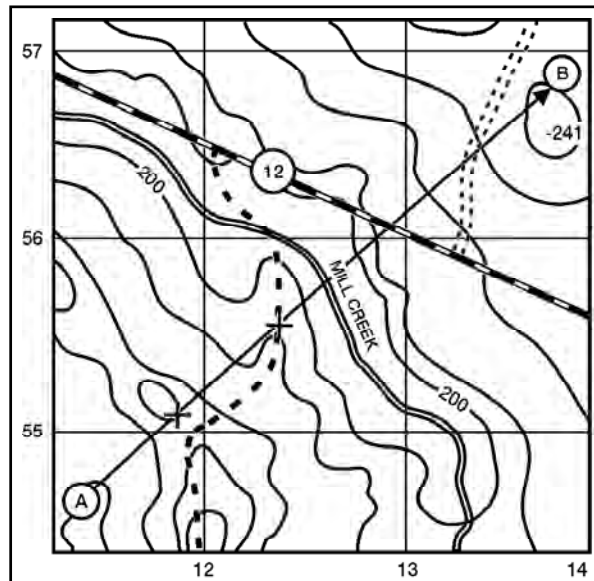


Figure 071-329-1006-1. Straight-line route

c. When adjusting your route, consider the following:

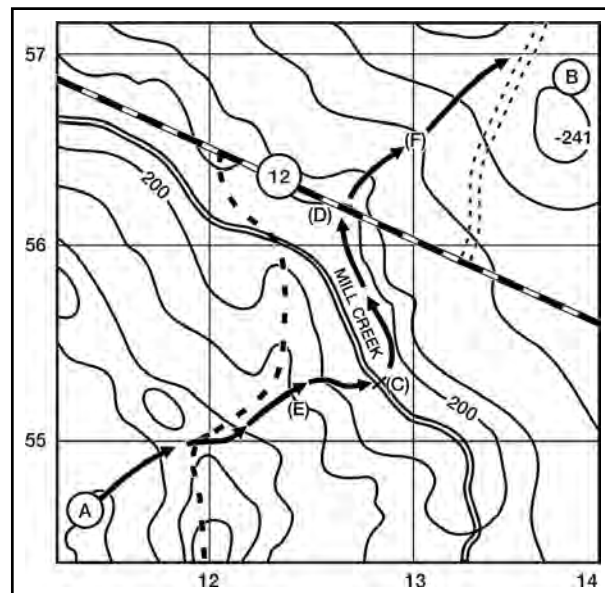
(1) Tactical aspect. Avoid skylining open areas and danger areas like streams or crossings on roads and hilltops. Your tactical concern is survival. The mission is causing you to move to your objective. You need to be sure you get to that objective. Looking at figure 071-329-1006-2, you decide for tactical reasons to cross the stream where you would not be seen from the road (C) and to cross the road in a small valley (D). You know that valleys offer better cover and concealment, so you will use them (E) (F).

---

---

**Performance Steps**

---



**Figure 071-329-1006-2. Adjusted route**

**(2) Ease of movement.** Always pick the easiest route that the tactical situation allows. However, you achieve surprise by doing the unexpected. A difficult route increases your chance of getting lost. A difficult route may be noisy and may tire you out before you get to your objective.

**(3) Boundaries.** It is almost impossible to travel in a straight line, with or without a compass. Pick an axis or corridor to travel along. Pick boundaries you will be able to spot or feel. Hard-top roads, streams, high grounds, and railroads all make good boundaries. If you start to wander too far off course, you will know it.

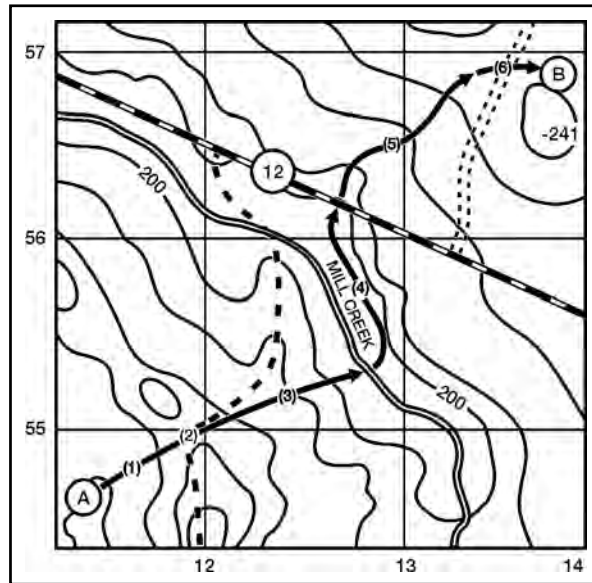
**d.** You decide the route shown in figure 071-329-1006-3 offers you easy movement. You check your axis up the valley (1); across the ridge at the saddle (2); cross the stream and turn left, keeping the stream on the left and high ground on the right (4); to the third valley (5); to the saddle, then on to the objective (6).

---

---

**Performance Steps**

---



**Figure 071-329-1006-3. Route of travel**

**e.** With boundaries to keep you straight, you need to know where, along your corridor, you are. You do this with checkpoints. The best checkpoint is a line or linear feature that you cannot miss. A linear feature across your corridor, or axis, is crossed no matter where you are in the axis. Use hard-top roads, railroads, power lines, perennial streams (solid blue lines, the dash blue lines are frequently dry), rivers, ridges, and valleys.

**Note.** DO NOT use light-duty roads and trails; there are always more on the ground than the map shows. DO NOT use wood lines, which are rarely permanent.

**f.** Referring to figure 071-329-1006-3, pick your checkpoints.

- (1) Saddle, use Hill 241 to line on up the right valley, and follow to—
- (2) Stream, move along it until—
- (3) Bend in the stream, turn right to—
- (4) Road in the valley (the ridge crossing on the road on the 12-grid line will serve as a limiting feature), then up to—
- (5) Far saddle, and right to your objective (B).

---

**Performance Steps**

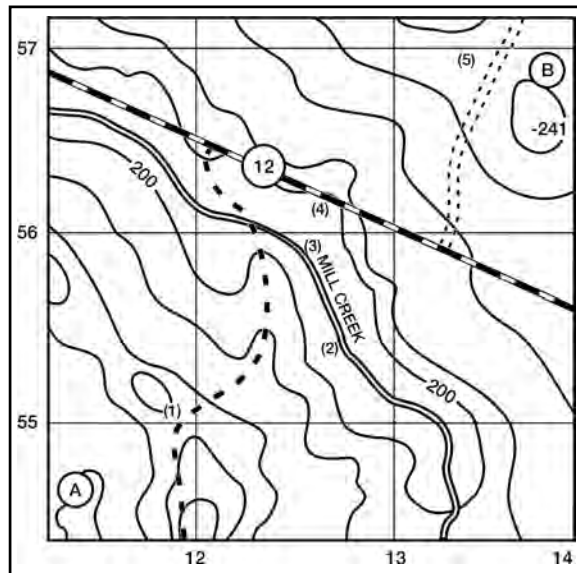
---

**g.** If you cannot find linear features, use an elevation change—hill or depression, small ridge, or valley. Look for one contour line of change during the day, two at night. Regardless of contour interval, you will spot a contour interval of change on foot.

**h.** Determine the distance between checkpoints. **DISTANCE IS THE CAUSE OF MOST NAVIGATIONAL MISTAKES.** Estimate or measure the distance from one checkpoint to another. Trust that distance.

**i.** Referring to figure 071-329-1006-4, check your distances:

- (1) 500 meters to the saddle (1).
- (2) 800 meters to the stream (2).
- (3) 500 meters to the bend in the stream (3).
- (4) 300 meters to the road (4).
- (5) 1,000 meters to the far saddle (5).



**Figure 071-329-1006-4. Checkpoints**

**3.** Navigate from one point to another using dead reckoning.

**a.** Dead reckoning is a technique of following a set route or line for a determined distance. This technique is used on flat terrain, like deserts and swamps. It can be used day or night. To use dead reckoning—

---

---

**Performance Steps**

---

(1) Locate the start point and finish point on the map (figure 071-329-1006-5).

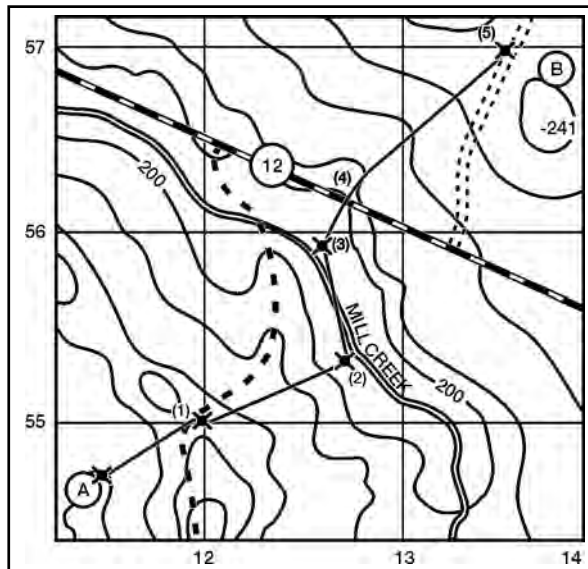


Figure 071-329-1006-5. Distance between checkpoints

(2) Determine the grid azimuth from the start point to the finish point, or to the first intermediate point on the map.

(3) Convert the grid azimuth taken from the map to a magnetic azimuth.

(4) Determine the distance between the start point and the finish point, or any intermediate points on the map.

**Note.** If you do not know how many paces you take for each 100 meters, you should move to a 100-meter course and determine your pace count.

(5) Convert the map distance to pace count.

(6) Make a thorough map reconnaissance of the area between the start point and the finish point.

---

---

**Performance Steps**

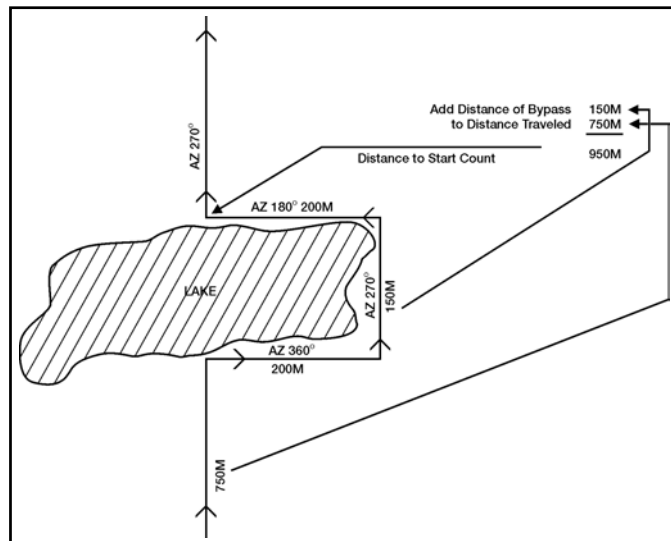
---

**b.** Before moving from the start point, shoot an azimuth on a well-defined object on the ground in the direction of travel. These objects, known as steering points, may be lone trees, buildings, rocks, or any easily identifiable point. At night, the most likely steering point will be a star. Because of the rotation of the Earth, the positions of the stars continually change. You must check your azimuth frequently. Do this only when halted. Using your compass while moving will cause you to go off-course. Your steering mark may be beyond your objective. Remember to travel the distance you determined.

**c.** Once you have selected a steering point, move toward it, remembering to begin your count. You should have some method devised to keep track of the number of 100 meters you travel.

**d.** Upon reaching your first steering point, shoot an azimuth to another steering mark, and repeat c, until you reach the finish point.

**e.** If you should encounter an obstacle, you may have to detour around it (figure 071-329-1006-6). To do this, complete a series of 90-degree turns until the obstacle is bypassed and you are back on the original azimuth.



**Figure 071-329-1006-6. Bypassing an obstacle**

**(1)** At the edge of the obstacle, make a note of the number of paces taken to this point.

---

---

**Performance Steps**

---

(2) If your detour is to the right, add 90 degrees to the original azimuth.

(3) Using the new azimuth, pick a steering mark and move toward it, making sure you begin a new pace count. Move on this azimuth until reaching the end of the obstacle.

(4) Stop and make a note of the number of paces taken, again as in (2) above, add or subtract 90 degrees from the azimuth just read, and move to the far side of the obstacle.

(5) Upon reaching the far side, stop the count and make note of the number of paces taken; add this pace count to the pace count noted in (1).

(6) At this time, again add or subtract 90 degrees from the azimuth used. Using this new azimuth, move the same number of paces taken on the first leg of the offset or detour.

(7) Place the compass on your original azimuth, pick up the pace count you ended with when you cleared the obstacle, and proceed to your finish point.

f. Bypassing the same obstacle at night calls for special considerations:

(1) To make a 90-degree turn, hold the compass as you would to determine a magnetic azimuth.

(2) Turn until the center of the luminous letter "E" is under the luminous line (do not change the setting of the luminous line).

**Note.** If you turn to the right, "E" is under the luminous line. If you turn to the left, "W" is under the line.

(3) Proceed in the direction until you have outflanked the obstacle.

(4) Turn until the north arrow is under the luminous line and proceed parallel to your original course until you have bypassed the obstacle.

(5) Turn until the "W" is under the luminous line and move back the same distance you originally moved.

(6) Finally, turn until the north arrow is under the luminous line and proceed on your original course.

(7) You must do the pace count the same as you do for bypassing the obstacle during daylight.

g. After reaching the finish point, conduct a detailed terrain analysis to confirm your location.

4. Navigate from one point to another by combining terrain association with dead reckoning.

---



---

### Performance Steps

---

a. Frequently, you must consider the advantage and disadvantage of both navigation techniques.

(1) Terrain association is fast and easy, and allows for mistakes. It is also subject to map accuracy and can only be used with recognizable terrain features.

(2) Dead reckoning is accurate and works on flat terrain that lacks terrain features; however, all work must be precise, and the technique takes time.

b. There may be times when you combine both techniques. For instance, in the desert, you may need to use dead reckoning to arrive at or near a road, or a ridge, and then use terrain association to follow that feature to an objective.

---

### Evaluation Preparation:

*Setup:* Select an area with varying terrain and vegetation and large enough to have two points, 1,000 meters to 2,000 meters apart. Ensure each point is on or near an identifiable terrain feature and marked on the ground with a sign containing a letter or number. Place dummy signs not less than 100 meters but not more than 200 meters to the right and left of the correct point. Clearly mark correct points on the map. Prepare a sheet of paper giving the azimuth and distance for each leg of the course to be covered. Have pencils available for the tested soldier.

#### *Brief Soldier:*

##### 1. Terrain Association.

a. Give the soldier the map and tell him to identify the best route to take between the two points plotted on the map (1,000 meters to 2,000 meters apart).

**Note.** The best route must have been determined by an SME before the test.

b. Give the soldier the map and tell him he must move from point A to point B (1,000 meters to 2,000 meters apart) using terrain association (no compass is used). Tell the soldier he has \_\_\_\_\_ (standard in minutes and/or hours) to complete the course.

2. Dead Reckoning. Give the soldier the sheet of paper with the azimuth and the distance for each leg of the course (three to five points, 200 meters to 500 meters apart), and the compass; no map will be used. Tell the soldier to move over the course shown by the azimuth and the distance on the paper. Tell the soldier to record the letter or number at the end of each leg of the course. Tell the soldier he has \_\_\_\_\_ (standard in minutes and/or hours) to complete the course.

**Note:** Time standards are based on the average time it takes two SMEs to complete the course plus 50 percent. For example, if the SME time is one hour, course test time is one hour and 30 minutes. SME time (1 hour) + 50 percent (30 minutes) = course test time of one hour and 30 minutes.

Tell the soldier he has 10 minutes to study the map and determine a course of action. At the end of this time, he will move to the start point and begin the test. Time starts when soldier leaves the start point and ends when he crosses the finish point.

Performance Measures	GO	NO GO
1. Terrain association.	_____	_____
a. Identified the best route within 10 minutes and explained the reason for picking that route.		
b. Wrote down the correct letter or number at the end of each leg of the course.		
2. Dead reckoning.	_____	_____
a. Wrote down the correct letter or number of each leg of the course.		
b. Arrived at correct destination within the specified time.		

**Evaluation Guidance:** Score the soldier GO if all performance measures are passed. Score the soldier NO GO if any performance measure is failed. If the soldier scores NO GO, show what was done wrong and how to do it correctly.

**References**

**Required**

FM 3-25.26  
STP 21-1-SMCT

**Related**

---

**071-329-1030**

**Navigate from One Point on the Ground to Another Point While Mounted**

**Conditions:** Given a standard 1:50,000-scale topographic map of the area, a coordinate scale, a protractor, and a compass, while mounted in a vehicle with cross-country capability and tasked to move from a known start point to one or more distant points.

**Note:** See appendix C for related skills and knowledge supporting performance of this task.

**Standards:** Directed the driver to the designated point(s) at a rate of nine kilometers per hour using terrain association and dead reckoning.

---

**Performance Steps**

---

1. Determine the effects of terrain on the vehicle when navigating mounted.

a. Vehicle speed and mobility.

(1) Great distances may be covered quickly. Develop the ability to estimate the distance traveled. Meanwhile, use the odometer, which shows the distance traveled. Remember that .1 mile is roughly 160 meters, and 1 mile is about 1,600 meters or 1.6 kilometers.

(2) Mobility is an advantage while navigating. When disoriented, mobility makes it easier to move and reorient.

b. Vehicle capabilities.

(1) Most military vehicles can knock down a tree. Larger vehicles can clear more trees but cannot knock down several trees at once. Find paths between trees that are wide enough for the vehicle (figure 071-329-1030-1).

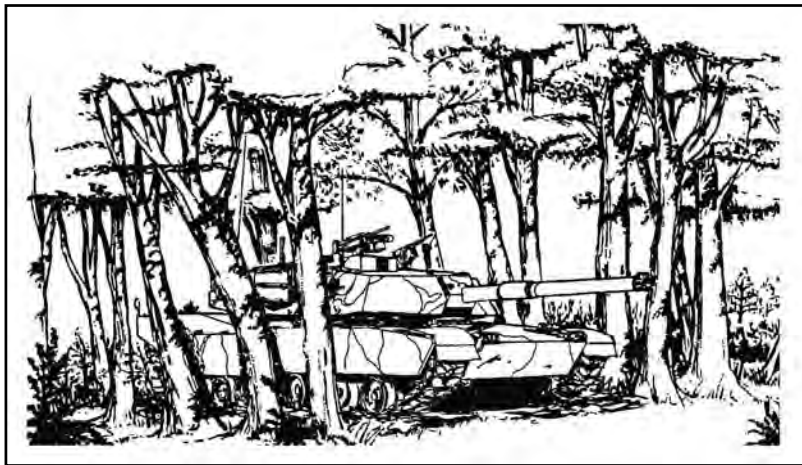


Figure 071-329-1030-1. Vehicle capabilities

---

---

## Performance Steps

---

### CAUTION

During training, follow installation SOP or local guidelines concerning cross-country vehicle travel.

(2) Military vehicles are designed to climb 60-percent (30-degree) slopes if the surface is dry and firm. If gravel, vegetation, or mud is on the slope, the practical slope-climbing capability is about 40 percent (20 degrees) (figure 071-329-1030-2).

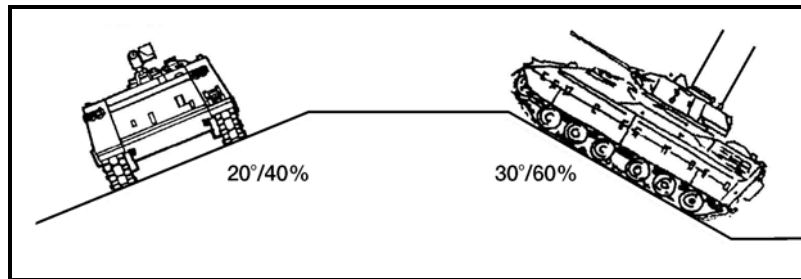


Figure 071-329-1030-2. Climbing slope and side slope capabilities

(a) Determine the approximate slope by looking at the route selected on a map. One contour line in any 100 meters of map distance on that route indicates a 10-percent slope. Two contour lines indicate a 20-percent slope, and so forth. If there are four contour lines in 100 meters, look for another route.

**Note.** The above figures are true for a 10-meter or 20-foot contour interval. If the map has a different contour interval, adjust the arithmetic. For instance, if there is one contour line in 100 meters, a 10-meter interval would give a 10-percent slope.

(b) The side slope is more important than the climbing slope. A 40-percent side slope is the maximum in good weather (figure 071-329-1030-2). Traverse a side slope slowly and without turning. Rocks, stumps, or sharp turns can cause a downhill track to be thrown under the vehicle, which is a major recovery task.

(3) For tactical reasons, movement is often in draws or valleys due to the cover they provide. Side slopes make slow movement necessary.

2. Know the effects of weather on vehicle movement.

a. Weather can halt mounted movement. Snow and ice are dangerous. Rain and snow affect soil load-bearing ability. Heavy rain may restrict cross-country vehicles to road movement.

b. Adjust the route to avoid flooded or muddy areas. A stuck vehicle hinders combat capability.

---

---

**Performance Steps**

---

**3. Know both methods of navigation.**

**a. Terrain association.** This is the most used method of navigation. The navigator plans the route for movement from one terrain feature to another. An automobile driver uses the same technique while driving along the streets in a city. He guides himself using intersections or other landmarks. Like a driver, the navigator selects routes, or "streets," between key points, or "intersections." These routes must sustain vehicle travel, and should be as direct and easy to follow as possible. In a typical move, the navigator determines his location and the location of his objective. He notes the position of each on his map and selects a route between the two.

**(1)** Determine the start point and destination.

**(2)** Draw or visualize a straight line between the two points on the map.

**(3)** Inspect the terrain along that line for ease of movement, for features recognizable under predicted weather conditions, and for tactical considerations.

**(4)** After analyzing the terrain, adjust the route by doing the following:

**(a)** Consider tactical aspects. Avoid skylining, select key terrain for overwatch positions, and select concealed routes.

**(b)** Consider ease of movement. Use the easiest possible route. Bypass difficult terrain. A difficult route is hard to follow, noisier, causes more wear to the vehicle (and possibly recovery problems), and takes more time. Tactical surprise is achieved by doing the unexpected. Try to select an axis or corridor and not a specific route. Allow room for vehicles to maneuver.

**(c)** Use terrain features as checkpoints. Checkpoints must be easily recognizable, from a moving vehicle, under the current light and weather conditions. The best checkpoints are linear features that cross the route. Use perennial streams, rivers, hardtop roads, ridges, valleys, and railroads. The next best are elevation changes; hills, depressions, spurs, and draws. Look for two contour lines of change. Less than two lines of change cannot be spotted while mounted.

**(d)** Follow terrain features. Movement and navigation along a valley floor or near or on the crest of a ridgeline are easiest.

---

---

**Performance Steps**

---

(e) Determine directions. Break the route into smaller segments and determine the rough direction that will be followed. The compass is not needed; use the main points of direction (north, northeast, east, for example). Before moving, note the location of the sun and the direction of north. Locate changes of direction, if any, at the checkpoints chosen.

(f) Determine distance. Obtain the total distance to be traveled and the approximate distance between checkpoints. Plan to use the vehicle odometer to keep track of distance traveled.

**Note.** Convert map distance to ground distance by adding 20 percent for cross-country movement.

(g) Make notes. Usually, mental notes are adequate. Imagine what the route will be like and remember it.

(h) Plan. Restudy the route selected. Determine where problems may occur and how they may be avoided.

b. Dead reckoning. Dead reckoning means moving a set distance along a set line. It involves moving so many meters along a set line, usually an azimuth in degrees.

**Note.** There is no accurate method of determining direction in vehicles.

(1) Dead reckoning with steering marks. This procedure is the same as it is for on foot travel.

(a) Dismount from the vehicle.

(b) Move away from the vehicle (about 50 meters).

(c) Set the azimuth on the compass and choose a steering mark (rock, tree, hilltop) in the distance on that azimuth.

(d) Remount and have the driver identify the steering mark. Proceed to it in as straight a line as possible.

(e) On arrival at the steering mark or when direction is changed, repeat paragraphs (a) through (c) for the next leg of travel.

(2) Dead reckoning without steering marks. Use this only in flat, featureless terrain.

(a) Dismount from the vehicle, which has been positioned in the direction of travel. Move about 50 meters to the front of the vehicle.

(b) Face the vehicle and read the azimuth to the vehicle.

(c) By adding or subtracting 180 degrees, determine the forward azimuth (direction of travel).

(d) Have the driver drive on a straight line toward you.

---

---

**Performance Steps**

---

(e) Remount the vehicle, hold the compass as it will be held while the vehicle is moving, and read the azimuth to the front.

(f) The compass swings off the azimuth determined, but it should pick up a constant deviation. For instance, the azimuth to the steering mark was 75 degrees while you were away from the vehicle. When you remounted, and the driver drove straight forward, the compass showed 67 degrees. There is a deviation of minus 8 degrees. All that is needed is to hold the 67-degree heading.

(g) At night, do the same thing without a steering mark. From the map, determine the azimuth of travel. Line the vehicle up on that azimuth, then move well in front of the vehicle. Be sure it is aligned correctly. Mount, have the driver move slowly forward, and note the deviation.

**Note.** If the vehicle has a turret, traversing the turret changes the deviation.

(3) Turret alignment. If the vehicle has a stabilized turret, another method is alignment of the turret on the azimuth to be traveled. Switch the turret stabilization system ON. The gun tube remains pointed at the destination no matter which way the vehicle is turned.

**CAUTION**

If you have to take the turret off-line to engage a target, repeat the entire process.

**Note.** This technique works, and it is not harmful to the stabilization system. However, the vehicle is subject to stabilization drift; therefore, use this technique for no more than 5,000 meters before resetting.

(4) Distance factor. Computing the distance factor in dead reckoning is usually a simple process. Determine the map distance to travel and add 20 percent to convert to ground distance. Use the vehicle odometer to control the distance of travel.

4. Learn to combine and use both methods.

a. Terrain association is fast and error-tolerant. It is the best method under most circumstances, and it can be used day or night.

b. Dead reckoning is accurate if done correctly—precision is a requirement. Dead reckoning is slow, but works in flat terrain.

c. Often, dead reckoning and terrain association are combined. Use dead reckoning to travel across a large, flat area to a ridge. Use terrain association for the rest of the move.

d. The ability to use both methods is required. Probable errors, in order of frequency, are as follows:

(1) Failure to determine distance(s) to be traveled.

---

---

**Performance Steps**

---

- (2) Failure to travel the proper distance.
  - (3) Failure to properly plot or locate the objective.
  - (4) Failure to select easily recognizable checkpoints or landmarks.
  - (5) Failure to consider the ease of movement factor.
- 

**Evaluation Preparation:**

*Setup:* At the test site, provide the materials and equipment given in the task conditions. Select an area that has varying terrain and vegetation. The area must be large enough to have three to five points that are 1,000 meters to 5,000 meters apart. Each point is on or near an identifiable terrain feature and is marked on the ground with a sign containing a letter or number. Place dummy signs not less than 100 meters or more than 200 meters to the right and left of the correct point. Clearly mark all correct points on the map. Prepare a sheet of paper giving the azimuth and distance for each leg of the course. Have pencils available for the soldier.

*Brief Soldier:*

1. Terrain association. Give the soldier the map and tell him to direct the driver and vehicle over the course recorded on the map. Tell the soldier to record the letter or number at the end of each leg of the course. Tell the soldier the course will be covered using terrain association.
2. Dead reckoning with steering marks. Give the soldier a protractor, a compass, and a sheet of paper with the azimuth and distance for each leg of the course. Maps are not used. Tell the soldier to direct the driver and vehicle over the course recorded on the paper. Tell the soldier to record the letter or number at the end of each leg to the course. Tell him the course will be covered using steering marks.

Performance Measures	GO	NO GO
1. Terrain association. Wrote the correct letter or number found at the end of each leg of the course.	___	___
2. Dead reckoning.	___	___
a. Moved away from the vehicle.		
b. Set azimuth on compass and selected steering mark.		
c. Had the driver identify the steering mark.		
d. Wrote the correct letter or number found at the end of each leg of the course.		
e. Repeated steps in performance measure 2a, b, and c for each leg of the course.		



**Evaluation Guidance:** Score the soldier GO if all performance measures are passed. Score the soldier NO GO if any performance measure is failed. If the soldier fails any performance measure, show what was done wrong and how to do it correctly.

**References**

**Required**

**Related**

FM 3-25.26

FM 90-3

**SUBJECT AREA 6: COMMUNICATE**

---

**113-571-1022**

**Perform Voice Communications**

**Conditions:** Given one operational radio set (warmed up and set to the net frequency) for each net member;; a call sign information card (5 inches x 8 inches) consisting of net member duty position (S1, S2), net call sign (letter-number-letter), suffix list (net control station [NCS] - 46, S1 - 39, S2 - 13), and a message to be transmitted.

*Situation:* The net is considered to be secure and authentication is not required (FM 24-19).

**Note.** This task may have as many net members as there is equipment available. Each net member must have a different suffix and message to transmit.

**Standards:** Entered a radio net, sent a message, and left a radio net using the proper call signs, call sign sequence, prowords, and phonetic alphabet and numerals with 100 percent accuracy.

---

**Performance Steps**

---

**1.** Enter the net.

---

**a.** Determine the abbreviated call sign and answering sequence for your duty position.

---

**b.** Respond to the NCS issuing a net call (figure 113-571-1022-1).

---

---

**Performance Steps**

---

NET THIS IS E3E (NCS) OVER E3E (NCS) THIS IS E13 (1 <sup>ST</sup> position) OVER E3E (NCS) THIS IS E39 (2 <sup>ND</sup> position) OVER E3E (NCS) THIS IS E46 (3 <sup>RD</sup> position) OVER NET THE E3E (NCS) OUT (IF NCS HAS NO TRAFFIC)
--

**Figure 113-571-1022-1.**

---

**c.** Answer in alphanumeric sequence.

---

**Note.** At this time, the NCS acknowledges and the net is open.

---

**2.** Send a message.

---

**a.** Listen to make sure the net is clear. Do not interrupt any ongoing communications.

---

**b.** Call the NCS and tell the operator the priority of the message you have for his station.

---

**c.** Receive a response from the NCS that he is ready to receive.

---

**d.** Send your message using the correct prowords and pronunciation of letters and numbers. (See tables 113-571-1022-1 through 113-571-1022-3 and figure 113-571-1022-2.)

---

**Performance Steps**

Table 113-571-1022-1. Phonetic Alphabet

<b>Letter</b>	<b>Word</b>	<b>Pronunciation</b>
A	ALFA	<u>AL</u> FAH
B	BRAVO	<u>BRAH</u> VOH
C	CHARLIE	<u>CHAR</u> LEE or <u>SHAR</u> LEE
D	DELTA	<u>DELL</u> TAH
E	ECHO	<u>ECK</u> OH
F	FOXTROT	<u>FOKS</u> TROT
G	GOLF	GOLF
H	HOTEL	HOH <u>TELL</u>
I	INDIA	<u>IN</u> DEE AH
J	JULIETT	<u>JEW</u> LEE <u>ETT</u>
K	KILO	<u>KEY</u> LOH
L	LIMA	<u>LEE</u> MAH
M	MIKE	MIKE
N	NOVEMBER	NO <u>VEM</u> BER
O	OSCAR	<u>OSS</u> CAH
P	PAPA	PAH <u>PAH</u>
Q	QUEBEC	KEH <u>BECK</u>
R	ROMEO	<u>ROW</u> ME OH
S	SIERRA	SEE <u>AIR</u> RAH
T	TANGO	<u>TANG</u> GO
U	UNIFORM	<u>YOU</u> NEE FORM or <u>OO</u> NEE FORM
V	VICTOR	<u>VIK</u> TAH
W	WHISKEY	<u>WISS</u> KEY
X	XRAY	<u>ECKS</u> RAY
Y	YANKEE	YANG KEY
Z	ZULU	<u>ZOO</u> LOO

---

**Performance Steps**

---

Table 113-571-1022-2. Number Pronunciation Guide

<b><i>Numeral</i></b>	<b><i>Spoken As</i></b>
0	<u>Z</u> E RO
1	WUN
2	TOO
3	TREE
4	<u>F</u> OW ER
5	FIFE
6	SIX
7	<u>S</u> EV EN
8	AIT
9	<u>N</u> IN ER

---

Table 113-571-1022-3.

<b><i>Proword</i></b>	<b><i>Meaning</i></b>
ALL AFTER	The portion of the message to which I have reference is all that which follows _____.
ALL BEFORE	The portion of the message to which I have reference is all that which precedes _____.
AUTHENTICATE	The station called is to reply to the challenge which follows _____.
AUTHENTICATION IS	The transmission authentication of this message is _____.
BREAK	I hereby indicate the separation of the text from other portions of the message.
CORRECT	You are correct, or what you have transmitted is correct.
CORRECTION	An error has been made in this transmission. Transmission will continue with the last word correctly transmitted.
	An error has been made in this transmission (or message indicated). The correct version is _____. That which follows is a corrected version in answer to your request for verification.
DISREGARD THIS TRANSMISSION OUT	This transmission is in error. Disregard it. This proword shall not be used to cancel any message that has been of national/allied forces or populace, and which require immediate delivery.

---

Table 113-571-1022-3.	
INFO	The addresses immediately following are addressed for information.
I AUTHENTICATE	The group that follows it is the reply to your challenge to authenticate.
I READ BACK	The following is my response to your instructions to read back.
I SAY AGAIN	I am repeating transmission or portion indicated.
I SPELL	I shall spell the next word phonetically.
I VERIFY	That which follows has been verified at your request and is repeated. (To be used as a reply to verify.)
MESSAGE	A message which requires recording is about to follow (Transmitted immediately after the call.)
MORE TO FOLLOW	Transmitting station has additional traffic for the receiving station.
OUT	This is the end of my transmission to you and no answer is required or expected. (Since OVER and OUT have opposite meanings, they are never used together.)
OVER	This is the end of my transmission to you and a response is necessary. Go ahead; transmit.
PRIORITY	Precedence PRIORITY. Reserved for important messages which must have precedence over routine traffic. This is the highest precedence which normally may be assigned to a message of administrative nature.
READ BACK	Repeat this entire transmission back to me exactly as received.
RELAY (TO)	Transmit this message to all addresses (or addresses immediately following this proword). The address component is mandatory when this proword is used.
ROGER	I have received your last transmission satisfactorily.
ROUTINE	Precedence ROUTINE. Reserved for all types of messages which are not of sufficient urgency to justify a higher precedence, but must be delivered to the addressees without delay.
SAY AGAIN	Repeat all of your last transmission. (Followed by identification data means "Repeat _____(portion indication).")
SERVICE	The message that follows is a service message.
SILENCE	"Cease Transmission Immediately." Silence will be maintained until lifted. (Transmissions imposing silence must be authenticated.)
SILENCE LIFTED	Silence is lifted. (When an authentication system is in force the transmission lifting silence is to be authenticated.)

Table 113-571-1022-3.	
SPEAK SLOWER	Your transmission is at too fast a speed. Reduce speed of transmission.
THIS IS	This transmission is from the station whose designator immediately follows.
TIME	That which immediately follows is the time or date/time group of the message.
TO	The addressee(s) immediately following is (are) addressed for action.
UNKNOWN STATION	The identity of the station with whom I am attempting to establish communications is unknown.
VERIFY	Verify entire message (or portion indicated) with the originator and send correct version. (To be used only at the discretion of the addressee to which the questioned message was directed.)
WAIT	I must pause for a few seconds.
WAITOUT	I must pause for longer than a few seconds.
WILCO	I have received your signal, understand it, and will comply. (To be used only by the addressee. Since the meaning of ROGER is included in that of WILCO, the two prowords are never used together.)
WORD AFTER	The word of the message to which I have reference is that which follows _____.

e. Get a receipt for the message.

**3. Leave the net in alphanumeric sequence.**

a. You receive a call from the NCS who issues a close-down order (figure 113-571-1022-2).

NET THIS IS E3E (NCS) CLOSE DOWN OVER E3E (NCS) THIS IS E13 (1 <sup>ST</sup> position) ROGER OUT E3E (NCS) THIS IS E39 (2 <sup>ND</sup> position) ROGER OUT E3E (NCS) THIS IS E46 (3 <sup>RD</sup> position) ROGER OUT
---

**Figure 113-571-1022-2**

b. Answer in alphanumeric sequence.

**Note.** The NCS acknowledges and the net is closed.

**Note.** The following call signs are used in this task as examples: Net call sign - E3E, NCS - E46, S1 - E39, S2 - E13.

**Evaluation Preparation:**

*Setup:* Position operational radio sets in different rooms or tents or at least 70 feet apart outside. Obtain call signs, suffixes, and a radio frequency through the normal command chain. Select a message (15 to 25 words) containing some number groups such as map coordinates and times. Print the call signs for the sender and the receiver, along with the message to be sent, on 5 x 8 cards. Perform a communications check to ensure operation of the radios. Have an assistant who is proficient in radio operation man the NCS. Provide the assistant with the call signs. If the soldier has not demonstrated sufficient progress to complete the task within five minutes, give him a NO GO. This time limit is an administrative requirement, not a doctrinal one. If the soldier has almost completed the task correctly, you may decide to allow him to finish.

*Brief Soldier:* Give the soldier the card containing the message and call signs. Tell him the radio is ready for operation, the net is considered to be secure and authentication is not required, and to send the message to the NCS and get a receipt. Tell the soldier that, if sufficient progress in completing the task within five minutes has not been demonstrated, he will receive a NO GO for the task.

Performance Measures	GO	NO GO
1. Entered the net in alphanumeric sequence.	___	___
2. Sent a message of 15 to 25 words using the correct prowords and phonetic alphabet and numerals.	___	___
3. Left the net in alphanumeric sequence.	___	___

**Evaluation Guidance:** Score the soldier GO if all performance measures are passed. Score the soldier NO GO if any performance measure is failed. If the soldier scores NO GO, show him what was done wrong and how to do it correctly.

**References****Required**

FM 24-19

**Related**

---

**113-600-2001****Communicate Via a Tactical Telephone**

**Conditions:** Given a requirement to communicate a message via a tactical telephone and the following:

1. An unclassified message (approximately 25 words).
2. A tactical telephone (DNVT, TA-838/TT, TA-341()/TT, TA-1042A/U and TA-954/TT) installed in a point-to-point configuration and operating in a non-secure mode.

**Standards:** Communicated the message within 10 minutes with no errors.

---

**Performance Steps**

1. Initiate call (lift handset from cradle).
  2. Verify distant end is ready to receive message.
  3. Communicate message.
  4. Verify message is received.
  5. Disconnect call (return handset to cradle).
- 

**Evaluation Preparation:**

*Setup:* Provide the soldier with—

1. Tactical telephone (DNVT, TA-838/TT, TA-341()/TT, TA-1042A/U and TA-954/TT) that is installed and connected to the distant tactical telephone (DNVT, TA-838/TT, TA-341()/TT, TA-1042A/U and TA-954/TT).
2. Tactical telephones (DNVT, TA-838/TT, TA-341()/TT, TA-1042A/U and TA-954/TT) are set to operate in the point-to-point mode.
3. A prepared message (approximately 25 words) for the soldier to communicate.

*Brief Soldier:* Tell the soldier he must communicate the prepared message.

Performance Measures	GO	NO GO
1. Initiated call (lifted handset from cradle).	___	___
2. Verified distant end is ready to receive message.	___	___
3. Communicated message.	___	___
4. Verified message was received.	___	___
5. Disconnected call (returned handset to cradle).	___	___

**Evaluation Guidance:** Score the soldier GO if all performance measures are passed. Score the soldier NO GO if any performance measure is failed. If the soldier scores NO GO, show him what was done wrong and how to do it correctly.

**References**

**Required**  
ACP 125 US SUPPL-1

**Related**

3-248

113-600-2001



**References**

**Required**  
ACP 125(E)

**Related**

---

**113-637-2001**

**Communicate Via a Tactical Radio in a Secure Net**

**Conditions:** Given an operational radio set (SINGGARS, IHFR, VRC-12 series, etc.), with an (SOI), fill device with appropriate fills, and fill cable, TM 11-5820-890-10-8, TM 11-5820-401-10-2, and an operational distant station.

**Standards:** Established voice communications with the distant tactical radio/network within three minutes.

---

**Performance Steps**

1. Place radio into operation.
  - a. Preset controls.
  - b. Turn radio set on.
  - c. Test radio transmission (RT) circuits.
2. Enter net.
  - a. Load appropriate fills.
  - b. Operate radio set.
3. Transmit message.
  - a. Establish secure communications.
  - b. Use prowords, call signs, frequencies, item numbers and authentications.

---

**Evaluation Preparation:**

*Setup:* An operational radio set (SINGGARS, IHFR, VRC-12 series, etc.), with an (SOI), fill device with appropriate fills, and fill cable, TM 11-5820-890-10-8, TM 11-5820-401-10-2, and an operational distant station.

*Brief Soldier:* Tell the soldier he must establish voice communications with the distant tactical radio/network, within three minutes. The three-minute limit is only an administrative training requirement.

Performance Measures	GO	NO GO
1. Placed radio into operation.	___	___
a. Preset controls.		

Performance Measures	GO	NO GO
b. Turned radio set on.		
c. Tested radio transmission (RT) circuits.		
2. Entered net.	___	___
a. Loaded appropriate fills.		
b. Operated radio set.		
3. Transmitted message.	___	___
a. Established secure communications.		
b. Used prowords, call signs, frequencies, item numbers, and authentications.		

**Evaluation Guidance:** Score the soldier GO if all performance measures are passed. Score the soldier NO GO if any performance measure is failed. If the soldier fails any performance measure, show what was done wrong and how to do it correctly. Have the soldier practice until the task can be performed correctly.

**References**

Required	Related
SOI	FM 24-18
TM 11-5820-401-10-2	FM 24-19
TM 11-5820-890-10-8	

**SUBJECT AREA 7: SEE**

**071-331-0804**

**Perform Surveillance without the Aid of Electronic Devices**

**Conditions:** Given an enemy force equipped with wheel and track vehicles within range of sight or hearing during day and night.

**Standards:** Identified 50 percent of the enemy soldiers and vehicles within field of view using proper surveillance techniques.

**Performance Steps**

1. Conduct a visual search in daylight.

---

**Performance Steps**

---

a. Make a fast overall search of the entire area by raising your eyes quickly from just in front of your position to the maximum range you wish to observe (figure 071-331-0804-1). (For a wide area, subdivide and repeat the procedure.)

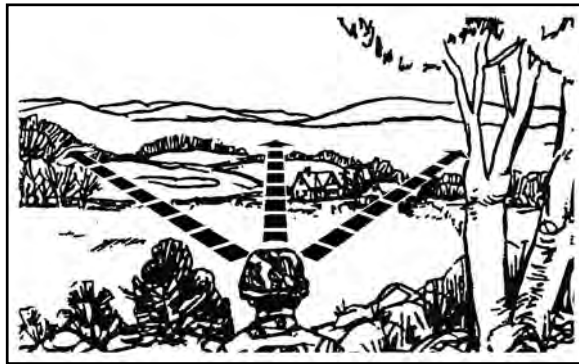


Figure 071-331-0804-1. Fast overall search

b. Observe by overlapping, 50-meter-deep strips of terrain in detail, alternately searching left to right, right to left (figure 071-331-0804-2).

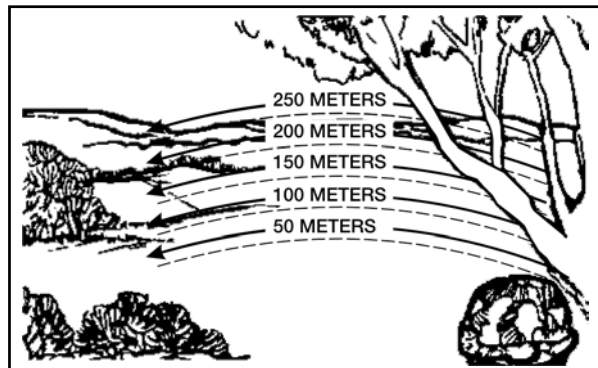


Figure 071-331-0804-2. Overlapping search

c. Search suspicious spots thoroughly.  
2. Identify improperly camouflaged personnel, equipment, and positions by looking for—

---

---

**Performance Steps**

---

- a. Camouflage or foliage that does not match.
  - b. Dead foliage.
  - c. Outlines that should be obscured.
  - d. Bright colors or reflections that should be subdued.
  - e. Tracks, footpaths, and piles of dirt and litter.
  - f. Over-clearing of fields of fire and observation.
3. Conduct surveillance at night:
- a. Accustom your eyes to low light before night operations by doing one of the following:
    - (1) Stay in a secure, darkened area for 30 minutes (for example, assembly area at night, initial rally point).
    - (2) Stay in a red-lighted area for 20 minutes, followed by 10 minutes in darkness.
    - (3) Wear red goggles for 20 minutes, followed by 10 minutes in darkness.
  - b. Scan search areas at night by moving your eyes in short, quick, irregular movements (figure 071-331-0804-3).



**Figure 071-331-0804-3. Night-vision search**

- c. Use off-center vision to observe specific objects by looking about 8 to 10 degrees left, right, above, or below them (figure 071-331-0804-4).
-

---

**Performance Steps**

---

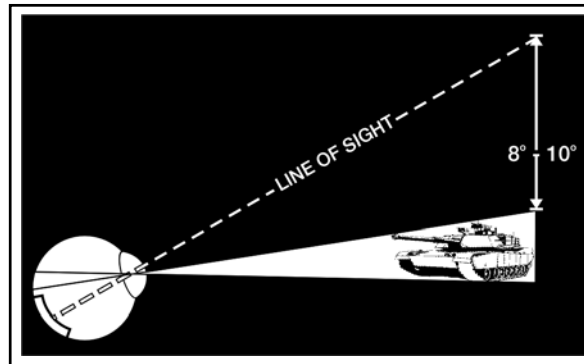


Figure 071-331-0804-4. Off-center vision

d. Preserve night vision by—

- (1) Closing both eyes when exposed to bright light.
- (2) Closing one eye only and observing with other when surveillance must be maintained.

**Note.** Maintaining surveillance is one of the basic, critical combat skills. Because it is hard to tell if the above techniques are used, frequent training is the only way to ensure mastery of this skill. This task is easy to integrate with other tactical training. In addition to the training given above, frequent familiarization with the sounds of vehicles and weapon fire, along with common smells, such as gasoline, campfires, and deodorants in the field environment is recommended.

---

**Evaluation Preparation:**

**Setup:** During a field exercise that involves camouflaging, have soldiers conduct day and night surveillance. Simulate situations described below. Have each soldier conduct surveillance at night and during the day before scoring the soldier GO or NO GO.

**Situation 1, day surveillance.**

- a. Improperly camouflaged enemy soldiers in fighting positions.
- b. Stationary, properly camouflaged vehicles.

**Situation 2, night surveillance.** Moving and stationary enemy soldiers silhouetted on the skyline.

**Brief Soldier:** Tell the soldier he must conduct surveillance during the day and at night. During surveillance, the soldier must locate 50 percent of the enemy soldiers within his field of view, and must differentiate between a tracked-vehicle and a wheeled-vehicle.

Performance Measures	GO	NO GO
1. Identified the following situations during daylight:	___	___
a. 50 percent of improperly camouflaged enemy soldiers in fighting positions.		
b. A camouflaged wheeled vehicle and a tracked vehicle.		
2. Identified the following situations during night surveillance.	___	___
a. Moving enemy soldiers.		
b. Stationary enemy soldiers.		

**Evaluation Guidance:** Score the soldier GO if all performance measures are passed. Score the soldier NO GO if any performance measure is failed. If the soldier scores NO GO, show him what was done wrong and how to do it correctly.

**References**

**Required**  
FM 21-75

**Related**

---

**071-730-0014**  
**Identify Combat Vehicles**

**Conditions:** Given combat vehicles.

**Standards:** Identified combat vehicles by actual nomenclature.

---

**Performance Steps**

1. Observe vehicle.
2. Observe vehicle characteristics.
3. Compare observed vehicle characteristics with known vehicle attributes. Four areas of characteristics are used to identify vehicles. Most armored vehicles have all four areas of characteristics, though not all vehicles do.
  - a. Track and suspension system: Many tanks can be recognized by their track and suspension systems. However, recognizing a vehicle by this feature alone is often difficult. Grass, dirt, terrain, dust or other factors often obscure the tracks. To identify the track and suspension system, check to see whether it has support or return rollers. Few threat vehicles, except the T-10, T-64, T-72, BMD, BMP, SP-122, and SP-152, have either.

---

**Performance Steps**

---

(1) Characteristics of most Warsaw Pact vehicles include a flat (Christie) suspension system, without support or return rollers, without torsion bars, and unevenly spaced road wheels.

(2) Characteristics of most NATO vehicles include a suspended track, support or return rollers, torsion bars, shock absorbers, and evenly spaced road wheels.

b. Turret: Most turrets can be grouped into three categories:

(1) Big, bulky turrets - older models.

(2) Well sloped turrets - newer models.

(3) Streamlined turrets - newer models.

c. Main gun: Armament varies from machine guns to large cannons. In turreted vehicles, normally the heaviest armament is in the turret. Look for the main gun, the main gun bore evacuator, and its relative location on the main gun.

(1) Types of main guns:

(a) Smooth main gun, without bore evacuator or blast deflector.

(b) Main gun with bore evacuator.

(c) Main gun with bore evacuator and muzzle brake or blast deflector.

(2) Types of muzzles:

(a) Single baffle.

(b) Double baffle.

(c) Multi-baffle.

d. Cupolas: The cupola is a small, turret-like projection normally on top of the turret. It is used by the vehicle commander and usually mounts a machine gun.

4. Eliminate any vehicle that does not possess an observed characteristic attribute.

5. Record actual vehicle.

---

**Evaluation Preparation:**

*Setup:* At the test site, provide the soldier(s) with all equipment and materials needed for testing. Before evaluating the soldier(s), check the computer/GTA media being used to ensure that it is operational. If using the ROC-V (Recognition of Combat Vehicles, a multimedia CD-ROM and Web-Based software package that teaches thermal and visual vehicle recognition), check the website <https://rocv.army.mil> to ensure the most

current version is accessed. Request access to download the ROC-V program from the webmaster at [mxregistrar@redstone.army.mil](mailto:mxregistrar@redstone.army.mil) . Check to ensure software has been loaded and set at the ready mode.

*Brief Soldier:* Read the following instructions to the soldier(s):

"At this time, you will be evaluated on your ability to identify combat vehicles. You must identify 28 of 40 vehicles by actual nomenclature."

Performance Measures	GO	NO GO
1. Observed vehicle.	___	___
2. Observed vehicle characteristics.	___	___
3. Compared observed vehicle characteristics with known vehicle attributes.	___	___
4. Eliminated any vehicle that did not possess an observed characteristic attribute.	___	___
5. Recorded vehicle.	___	___

**Evaluation Guidance:** Score the soldier an overall GO if 28 combat vehicles out of 40 were correctly identified. Score the soldier NO GO if any performance measure is failed. If the soldier scores NO GO, show him what was done wrong and how to do it correctly.

#### References

##### Required

##### Related

FM 3-23.24

FM 3-90.1

GTA 17-02-011

GTA 17-02-013

## SUBJECT AREA 8: HAND GRENADES AND LAND MINES

### 071-325-4401

#### Perform Safety Checks on Hand Grenades

**Conditions:** Given any standard issue U.S. hand grenade with extra safety clips and load-carrying equipment (LCE).

**Standards:** Inspected the grenade for defects; identified and corrected defects, if possible. Reported and turned in grenades that had defects you



could not correct. Identified each grenade by type and correctly attached grenades to ammunition pouch.

---

**Performance Steps**

1. Identify the grenades listed in table 071-325-4401-1 by type, color, markings, and usage.

Table 071-325-4401-1. Hand Grenades		
Type	Color/Markings	Use
M67 Fragmentation	OD with yellow marking.	To disable or kill personnel. Explodes 4 to 5 seconds after safety lever is released
M18 Colored Smoke	OD with color of smoke on top	To signal personnel.
M34 WP Smoke	Light green, yellow band, red marking. "OLD MARKING" light gray, yellow band, yellow printing.	To signal personnel. Produces casualties up to 35 meters away.
AN-M8 HC Smoke	Light green, black marking, white top.	To screen, (provide concealment).
AN-M14 TH3 Incendiary	Light red with black lettering.	To destroy equipment and start fires.
AB M52A2 CS Riot Control	Gray, red band(s) and markings	To control riots or disable individuals without serious injury.

2. Inspect hand grenades for defects; correct defects, if possible.
- a. Check the fuse to ensure it is screwed tightly on the body of the grenade.
  - b. Check the safety clip to ensure—
    - (1) It is present.
    - (2) It is in the correct position.
- Note.** Perform step 2c only if necessary.
- c. Replace missing safety clips.
    - (1) Slide the clip onto the handle.
    - (2) Attach the loop portion of the clip around the fuse.
    - (3) Snap the clip end around the safety lever.
  - d. Check the safety pin.
-

---

**Performance Steps**

---

- (1) Ensure the clip is in the correct position. If not in position, carefully push it into place while holding the safety lever down.
- (2) Ensure the clip is not bent. If it is bent, carefully bend it back in position.
  - e. Check the safety ring for cracking and reject the grenade with a cracked safety ring.
  - f. Check grenades for dirt. Wipe dirty or grimy grenades with a cloth.
  - g. Turn in defective grenades.

**WARNING**

Do not attempt to modify a grenade. Do not attempt to defuse a grenade. Do not attempt to remove a grenade found upside down in its packing container. Do not handle a dud grenade. Do not attach grenades to clothing or equipment by the pull ring.

3. Attach the grenade to an ammunition pouch.
  - a. Attach the grenade to the new style pouch.
    - (1) Slip the grenade safety lever over the small strap (sewn to each side of the ammunition pouch).
    - (2) Push the grenade down until it is firmly seated against the side of the pouch.
    - (3) Ensure the pull ring is pointed downward.
    - (4) Wrap the carrying strap around the fuse including both the safety lever and the pull ring.
  - b. Attach the grenade to the old style pouch.

**Note.** A small strap is sewn to each side of the pouch.

    - (1) Slip the safety lever over the strap and push the grenade down until it is firmly seated against the side of the pouch.
    - (2) Ensure the pull ring is pointed downward, wrapping the carrying strap around the fuse, including the safety lever and pull ring.
4. Check grenades occasionally while moving to ensure the fuse is tight and the strap is secure.

---

**Evaluation Preparation:**

*Setup.* Provide the following six inert hand grenades: M67 fragmentation grenade, M18 colored smoke grenade, M34 WP smoke grenade, AN-M8 HC smoke grenade, AN-M14 TH3 incendiary grenade, and ABC-M25A2 CS riot-control grenade. The soldier being tested is not required to identify the

grenades alphanumeric nomenclatures. Secure a number of inert hand grenades that contain at least two of the following defects:

1. The fuse is unscrewed from the body of the grenade.
2. A loose safety clip.
3. A partially removed and/or bent safety pin.
4. A cracked safety pin.
5. A broken safety lever.
6. A dirty grenade.

Ensure that you know the defects present in each grenade before testing the soldier.

*Brief Soldier:* Tell the soldier he must identify each hand grenade. Tell the soldier to inspect the grenade and to correct the defects where possible. If the soldier discovers a defect that cannot be corrected, he must tell you the defect and that the grenade should be turned in. Tell the soldier to attach a grenade to his ammunition pouch.

Performance Measures	GO	NO GO
1. Identified each of the following grenades:	___	___
a. Fragmentation grenade.		
b. Riot control grenade.		
c. White phosphorus (WP) grenade.		
d. HC (white) smoke grenade.		
e. Colored smoke grenade.		
f. Incendiary grenade.		
2. Inspected the grenade.	___	___
a. Checked that the fuse was screwed in tightly on the body of the grenade.		
b. Checked the position of the safety clip.		
c. Checked the safety pin. If wrongly positioned, carefully pushed it into place while securely holding the lever down. If bent, carefully bent it back into position.		
d. Checked the safety ring for cracking and rejected the grenade with a cracked safety ring.		
e. Checked for dirt and wiped the grenade clean, if dirty.		
f. Turned in defective grenades.		

Performance Measures	GO	NO GO
3. Attached the grenade to the ammunition pouch.	___	___
a. Checked the fuse for tightness.		
b. Slipped the grenade safety lever over the strap on the side of the ammunition pouch with the pull ring or safety pin pointing downward.		
c. Wrapped the carrying strap around the neck of the fuse including the safety lever and the pulled ring, snapped the carrying strap to the carrying sleeve.		

**Evaluation Guidance:** Score the soldier GO if all performance measures are passed. Score the soldier NO GO if any performance measure is failed. If the soldier scores NO GO, show him what was done wrong and how to do it correctly.

#### References

**Required**

**Related**

TM 9-1330-200-12

---

## 071-325-4407

### Employ Hand Grenades

**Conditions:** Given an offensive (concussion), riot-control, smoke, or incendiary grenade with a time-delay fuse and load-carrying equipment (LCE).

**Standards:** Threw the hand grenade to hit the target, prevented endangering yourself for more than five seconds.

---

#### Performance Steps

1. Position your body in a comfortable and natural position.
  - a. Make sure you are in a covered position.
  - b. Look at the target and judge the distance to the target.
  - c. Align your body with the target as if you are going to throw a football or baseball.

**Note.** This is body target alignment.

2. Grip the hand grenade as follows:
    - a. Hold the safety lever down with your thumb.
-

---

**Performance Steps**

---

b. Keep the pull ring and safety clip (if present) free and facing your throwing hand.

3. Arm the grenade.

a. Remove the safety clip.

**Note.** Hold the safety lever down by your thumb. This keeps the pull ring and safety clip free and facing the non-throwing hand.

b. Pull the pin.

4. Confirm body target alignment.

a. TARGET—Troops in the open. EFFECTIVE ENGAGEMENT—Within five meters of center.

b. TARGET—Troops with overhead cover. EFFECTIVE ENGAGEMENT—Inside the enclosure.

c. TARGET—Troops dug in without overhead cover. EFFECTIVE ENGAGEMENT—Inside the position.

5. Toss the grenade using an overhand movement. Release the grenade when it comes into your field of vision ensuring that you—

a. Keep your eyes on the target.

b. Follow through your throwing motion.

c. Take cover, exposing yourself to fire for no more than five seconds.

6. Return to the position behind cover until the grenade detonates, exposing yourself for no more than five seconds at any one time.

7. Detonate the grenade within the effective bursting radius of the target.

---

**Evaluation Preparation:**

*Setup:* At the test site, provide the soldier with five dummy grenades to engage the targets. Provide targets of troops in the open, troops with overhead cover, or troops dug in without overhead cover.

*Brief Soldier:* Tell the soldier to fasten four of the grenades to the ammunition pouches on his LCE and to hold one in his hand. Tell the soldier that at least one grenade must detonate within the effective bursting radius of the target. Tell the soldier not to expose himself for more than five seconds at any one time.

Performance Measures	GO	NO GO
1. Positioned body in a covered position, aligned as if to throw a football or a baseball.	—	—

Performance Measures	GO	NO GO
2. Gripped the hand grenade, held the safety lever down with thumb, kept the pull ring free, and faced throwing hand.	—	—
3. Armed the grenade by removing the safety clip and the pull ring.	—	—
4. Confirmed body target alignment by looking at the target.	—	—
5. Threw the grenade overhand while keeping eyes on the target.	—	—
6. Returned to the position behind cover until the grenade was detonated, prevented exposure of self for no more than five seconds at any one time.	—	—
7. Detonated the grenade within the effective bursting radius of the target.	—	—
<b>Note.</b> The soldier will not be scored a NO GO for a target until he has thrown all five grenades.		

**Evaluation Guidance:** Score the soldier GO if all performance measures are passed. Score the soldier NO GO if any performance measure is failed. If the soldier scores NO GO, show him what was done wrong and how to do it correctly.

#### References

##### Required

TM 9-1330-200-12

##### Related

---

## 071-325-4425

### Employ an M18A1 Claymore Mine

**Conditions:** You must employ the M18A1 Claymore mine against enemy targets. Given an M18A1 Claymore mine in a bandoleer, an M57 firing device, an M40 test set, and a firing wire with blasting cap, packed in an M7 bandoleer; a sandbag; and two wooden stakes.

#### Standards:

1. Conducted a circuit test of the firing device with the blasting cap secured under a sandbag.
2. Installed the M18A1 Claymore mine so—
  - a. The front of the mine was centered on a kill zone.

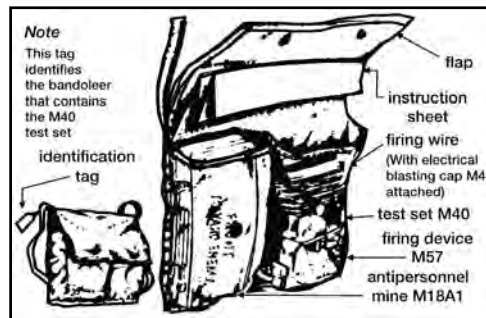
3-262

071-325-4425

- b. The firing device was 16 meters to the rear or side of the emplaced mine and fired from a covered position.
  - c. The mine, firing wire, and firing device were camouflaged.
  - d. The installation was confirmed by conducting a final circuit test.
3. Fired the mine by actuating the firing device handle with a firm, quick squeeze when the target was in the kill zone.

**Performance Steps**

1. Inventory the M18A1 Claymore mine bandoleer, accounting for all accessories. (figure 071-325-4425-1).

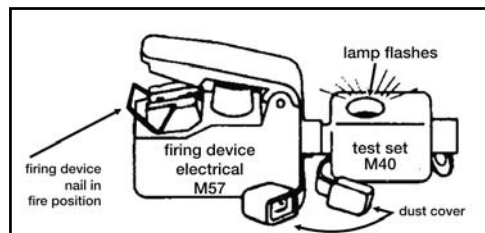


**Figure 071-325-4425-1. Components of the M18A1 Claymore mine**

**WARNING**

During testing and installation, keep the M57 firing device in your possession to prevent accidental firing by someone else.

2. Conduct a circuit test at the firing point (figure 071-325-4425-2).



**Figure 071-325-4425-2. Circuit test of the M57 firing device and M40 test set**

- a. Remove the electrical wire and accessories while leaving the mine in the bandoleer.

---

**Performance Steps**

---

b. Remove the dust cover from the connector of the M57 firing device and from the female connector of the M40 test set.

c. Plug the test set into the firing device.

d. Position the firing device bail to the FIRE position.

e. Actuate the handle of the firing device with a firm, quick squeeze, observing the flash of light through the window of the test set.

**Note.** The flashing light indicates that the M57 firing device and M40 test set are functioning correctly.

f. Remove the shorting plug cover from the connector of the firing wire and from the end of the test set.

g. Plug the connector of the firing wire into the test set (figure 071-325-4425-3).

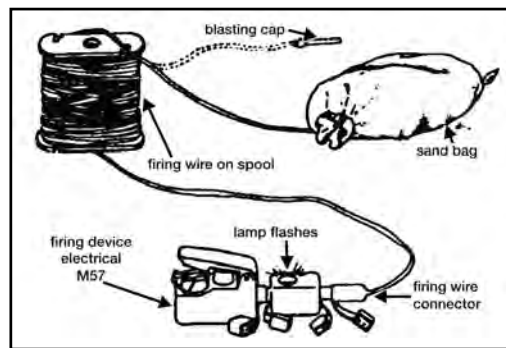


Figure 071-325-4425-3. Circuit test of the M18A1 Claymore mine firing system

**WARNING**

The blasting cap must be placed under a sandbag, behind a tree or in a hole in the ground to protect the person performing the circuit check in case the blasting cap detonates.

h. Place the M57 firing device bail in the FIRE position and actuate the firing handle.

**Note.** The lamp in the window of the M40 test set should flash.

i. Place the firing device on SAFE, remove the M57 firing device and M40 test set.

j. Place the shorting plug cover on the firing wire.

---



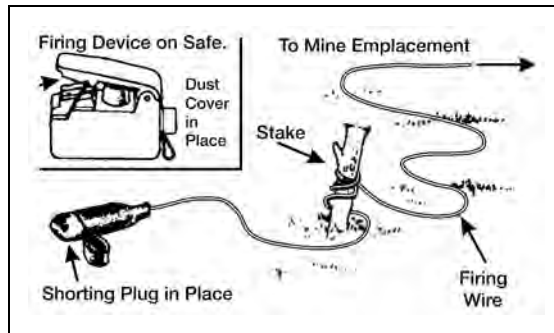
---

**Performance Steps**

---

**3. Install the M18A1 Claymore mine.**

- a.** Tie the shorting plug end of the firing wire to a fixed object, such as a stake or tree at the firing position (figure 071-325-4425-4).



**Figure 071-325-4425-4. Firing wire secured**

- b.** Place the bandoleer on your shoulder.
- c.** Unroll the firing wire to the selected installation position.

**Note.** The firing wire is laid from the firing position to the mine installation site because the blasting cap end is on the inside of the firing wire spool.

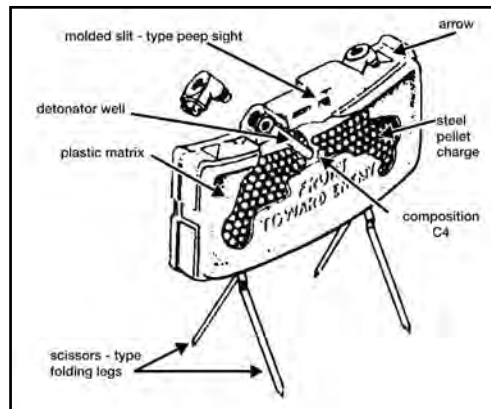
**4. Aim the mine.**

- a.** Remove the mine from the bandoleer.
  - b.** Open both pairs of legs to a 45-degree angle with two legs facing to the front and two legs facing to the rear of the mine (figure 071-325-4425-5).
-

---

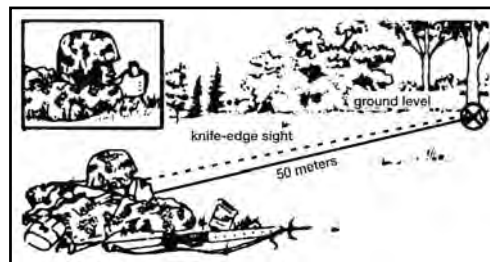
## Performance Steps

---



**Figure 071-325-4425-5. Placing and aiming the mine**

c. Push the legs about one-third of the way into the ground with the mine facing in the desired direction of fire. In windy areas or when the legs cannot be pressed into the ground, spread the legs as far as they will go (about 180 degrees) so the legs are to the front and rear of the mine and the mine will not tip over.



**Figure 071-325-4425-6. Aiming knife-edge sight**

d. Select an aiming point at ground level about 50 meters (150 feet) in front of the mine (figure 071-325-4425-6).

e. Position one eye about 6 inches to the rear of the sight.

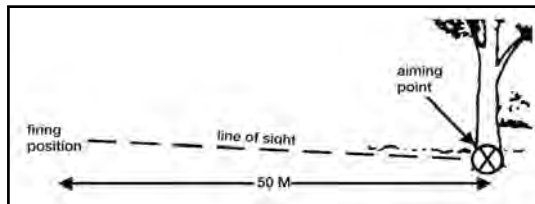
(1) On a knife-edge sight, align the two edges of the sight with the aiming point (figure 071-325-4425-7 and figure 071-325-4425-8).

---

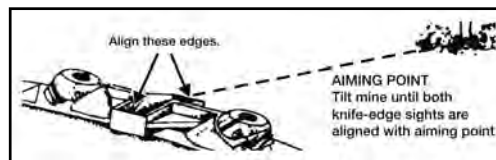
---

**Performance Steps**

---

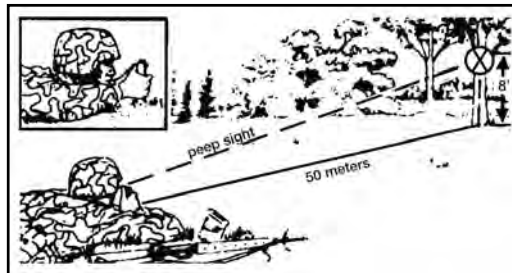


**Figure 071-325-4425-7. Aiming knife-edge sight (continued)**



**Figure 071-325-4425-8. Aiming knife-edge sight (continued)**

(2) On a slit-type peep sight, align the groove of the sight with the aiming point that is 2.5 meters (8 feet) off the ground (figure 071-325-4425-9 and figure 071-325-4425-10).



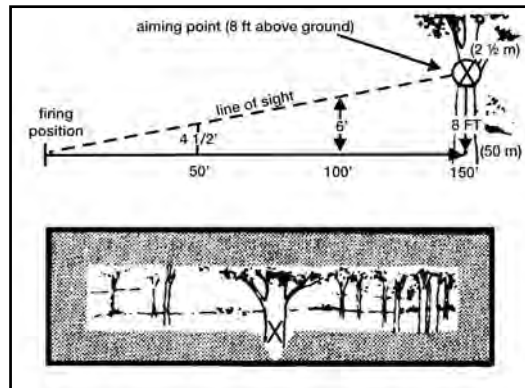
**Figure 071-325-4425-9. Aiming slit-type peep sight**

---

---

## Performance Steps

---



**Figure 071-325-4425-10. Aiming slit-type peep sight (continued)**

**Note.** The aiming point should be in the center of the desired area of coverage with the bottom edge of the peep sight parallel to the ground that is to be covered with the fragment spray.

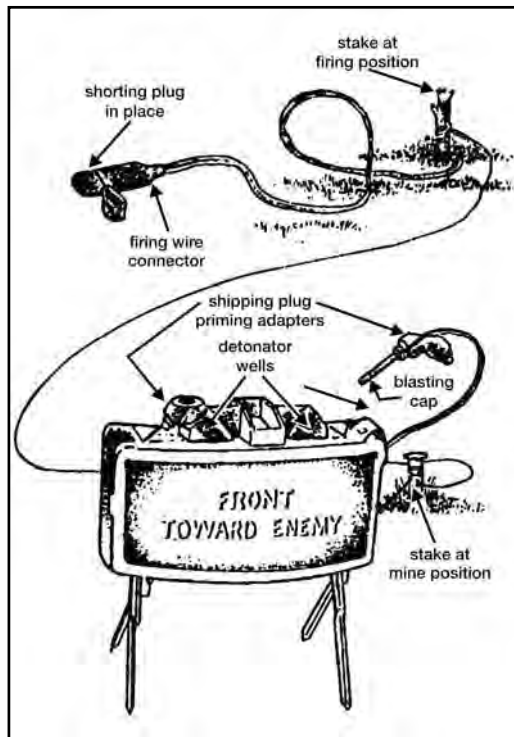
**5. Arm the mine.**

- a.** Secure the firing wire about one meter to the rear of the mine so the mine will not become misaligned if the firing wire is disturbed.
  - b.** Unscrew one of the shipping plug priming adapters from the mine.
  - c.** Slide the slotted end of the shipping plug priming adapter onto the firing wire of the blasting cap between the crimped connections and the blasting cap.
  - d.** Pull the excess wire through the slotted end of the adapter until the top of the blasting cap is firmly seated in the bottom portion of the shipping plug priming adapter (figure 071-325-4425-11).
-

---

**Performance Steps**

---



**Figure 071-325-4425-11. Arming the mine**

- e. Screw the adapter, with the blasting cap, into the detonator well.

**WARNING**

Ensure that the face of the mine marked "front toward enemy" and the arrows on the mine point in the direction of the enemy.

- f. Recheck the aim of the mine.
6. Camouflage the mine.
7. Bury the firing wire (if possible) from the mine back to the firing position.
-

---

**Performance Steps**

---

**Note.** The firing position should be in a hole or covered position at least 16 meters to the rear or the side of the emplaced mine.

**WARNING**

The M40 test set must be used during retest of the circuit.

- Repeat step 2 to test the circuit after the firing wire is laid out and the cap is placed inside the mine to see if there are any breaks in the wire (figure 071-325-4425-12).

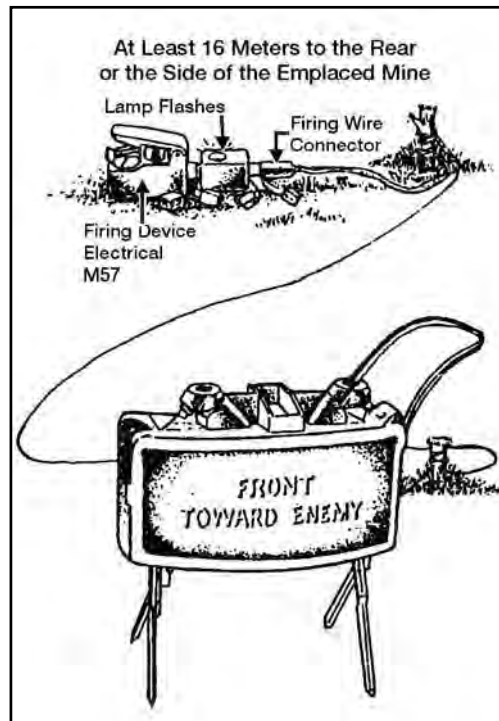


Figure 071-325-4425-12. Retesting the circuit

---

---

### Performance Steps

---

**Note.** To ensure that the mine will function properly after installation, retest the firing circuit to check for any break in the wire that may have occurred during installation.

**Note.** Friendly troops within 250 meters to the front and sides and 100 meters to the rear of the mine must be under cover.

#### WARNING

You must be behind cover or in a fighting position when retesting the circuit on a Claymore mine with the blasting cap inserted in the detonation well.

9. Fire the mine.
  - a. Remove the dust cover from the firing device and firing wire.
  - b. Connect the firing wire to the firing device.
  - c. Position the firing device safety bail in the FIRE position (figure 071-325-4425-13).

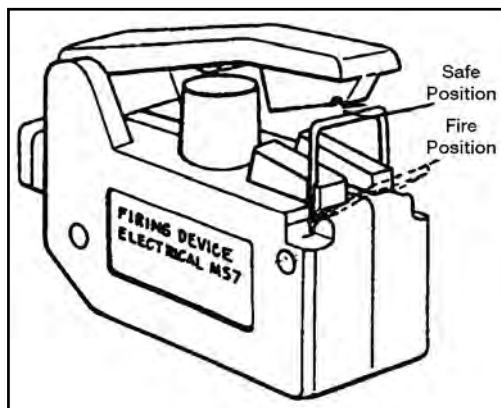


Figure 071-325-4425-13. Firing device in the SAFE position

- d. Actuate the firing device handle with a firm, quick squeeze.
- e. Assume a prone position behind cover.

**Note.** The mine is most effective when employed against targets 20 to 30 meters in front of it.

---

### Evaluation Preparation:

*Setup:* During training, use only inert blasting caps and mines. At the test site, place one M7 bandoleer containing an inert M18A1 Claymore mine, an M57 firing device, and an M40 test set. Check to make sure each mine is

complete and serviceable. Place one wooden stake in the ground at the test position and another at the mine emplacement point. The distance between the emplacement point and firing point must be no less than 16 meters. The stake at the aiming point should be painted red or some other distinguishable color. Once the soldier has emplaced the mine and completed the circuit test, assume a prone position and visually confirm that the mine is correctly aimed. To assist you, place stakes one meter on each side of the aiming point stake. The height of the stakes should not exceed one foot above the ground. During the circuit test, do not attempt to observe the flash on the M40 test set because it may interfere with the soldier's performance. Throughout the evaluation, if the soldier states that he cannot see the flashing light, tell him "CONTINUE WITH THE TEST."

*Brief Soldier:* Tell the soldier to perform a circuit check on the firing wire and then install the mine. Camouflaging and burying the wire are not covered during the evaluation.

Performance Measures	GO	NO GO
1. Inventoried the M18A1 Claymore mine bandoleer, and ensured all components were present and in serviceable condition.	___	___
2. Conducted a circuit test.	___	___
a. Removed the electrical wire and accessories while leaving the mine in the bandoleer.		
b. Removed the dust cover from the connector of the M57 firing device and from the female connector of the M40 test set.		
c. Plugged the test set into the firing device.		
d. Positioned the firing device bail to the FIRE position.		
e. Actuated the firing handle, and observed the flash in the test set window.		
f. Removed the shorting plug cover from the connector of the firing wire and from the end of the test set.		
<b>Note.</b> The soldier can place the sandbag over the blasting cap any time before plugging the test set into the firing wire connector.		
g. Plugged the test set into the firing wire connector.		
h. Placed the M57 firing device bail in the FIRE position and actuated the firing handle.		



Performance Measures	GO	NO GO
i. Placed the firing device on SAFE, removed the M57 firing device and M40 test set.		
j. Placed the shorting plug cover on the firing wire.		
3. Installed the M18A1 Claymore mine.	___	___
a. Tied the shorting plug end of the firing wire to fixed object (stake, tree, etc.) at the firing position.		
b. Placed the bandoleer on shoulder.		
c. Unrolled the wire to the mine emplacement site.		
4. Aimed the mine.	___	___
5. Armed the mine.	___	___
a. Secured the wire at the mine site.		
b. Inserted the blasting cap in either detonator well.		
c. Locked the blasting cap in place with the shipping plug priming adapter.		
d. Rechecked the lay of the mine.		
<b>Note.</b> If the soldier tries to put the blasting cap through the hole in the shipping plug priming adapter, he fails performance measure 3.		
6. Camouflaged the mine.	___	___
7. Buried the firing wire from the mine back to the firing position.	___	___
8. Rechecked the circuit.	___	___
a. Removed the electrical wire and accessories while leaving the mine in the bandoleer.		
b. Removed the dust cover from the connector of the M57 firing device and from the female connector of the M40 test set.		
c. Plugged the test set into the firing device.		
d. Positioned the firing device bail to the FIRE position.		
e. Actuated the firing handle.		
f. Observed the flash through the window on the test set.		

Performance Measures	GO	NO GO
g. Placed a sandbag over the blasting cap.		
h. Plugged the test set into the firing wire connector.		
i. Actuated the firing handle and observed the window in the test set for a flash.		
j. Placed the firing device on SAFE.		
k. Replaced the shorting plug cover on the firing wire.		
9. Fired the M18A1 Claymore mine.	_____	_____
a. Removed the dust cover from the firing device and firing wire.		
b. Connected the firing wire to the firing device.		
c. Positioned the firing device safety bail in the FIRE position.		
d. Actuated the firing device handle with a firm, quick squeeze.		
e. Assumed a prone position behind cover.		
<b>Note.</b> The soldier may assume the prone position any time before placing the firing device on FIRE.		
f. Completed steps 9a through 9e sequence.		

**Evaluation Guidance:** Score the soldier GO if all performance measures are passed. Score the soldier NO GO if any performance measure is failed. If the soldier scores NO GO, show him what was done wrong and how to do it correctly.

#### References

**Required**  
FM 23-23

**Related**

**SUBJECT AREA 9: M16-SERIES RIFLE**

---

**071-008-0007**

**Engage Targets with an M16-Series Rifle Using an AN/PAS-13 Series Thermal Weapon Sight**

**Conditions:** Given an M16-series rifle with a mounted and zeroed AN/PAS-13 series thermal weapon sight (TWS), loaded magazines with 5.56-mm ammunition, threat targets, and a requirement to engage such targets.

**Standards:** Detected and determined range to targets. Fired the M16-series rifle to engage targets in the assigned sector of fire. Applied correct marksmanship fundamentals and target engagement techniques so each target was hit or suppressed.

---

**Performance Steps**

1. Place TWS into operation.
  2. Assume an appropriate firing position based on the situation. The firing position should protect you from enemy fire and observation, yet allow you to place effective fire on targets in your sector of fire.
    - a. Foxhole. Advantages: best when available. Disadvantages: no overhead cover.
    - b. Prone. Advantages: steady, easy to assume, low silhouette, and easily adapted to use of cover and support. Disadvantages: effectiveness can be limited by terrain and vegetation irregularities.
    - c. Prone supported. Advantages: steadier than prone, other advantages the same as prone. Disadvantages: same as prone.
    - d. Kneeling. Advantages: used when firing from behind something, used on ground that is level or gently sloping upward. Disadvantage: exposed to small arms fire.
    - e. Kneeling supported. Advantages: steadier than kneeling; other advantages the same as kneeling. Disadvantages: exposure to small arms fire.
    - f. Standing. Advantages: used in assault to surprise targets or when other positions are not appropriate. Disadvantages: Unstable and allows more exposure to small arms fire.
  3. Identify targets in your designated sector of fire.
  4. Load the weapon.
-

---

**Performance Steps**

---

5. Acquire targets using TWS reticle. Use the small dots shown in a horizontal row to the right of the reticle center as aiming points for M16-series rifles.

a. Personnel: Place the target on the horizontal line and match its height with one of the vertical lines. Measurement is made from the horizontal line to the top (or bottom) of each vertical line for the range indicated.

b. Tank: When viewed from the side, place the left edge of tank at the left side of the horizontal line. Read the range to the tank from the scale at the right edge of the tank. When viewed from front or rear, use one half the indicated range value (because width of the tank is approximately half the length of the tank).

6. Fire on target(s) until they are destroyed or until you receive an order to cease fire.

---

**Evaluation Preparation:**

*Setup:* Evaluate this task on a live-fire range. Provide the soldier with the equipment and materials in task conditions.

*Brief Soldier:* Brief the soldier on range safety according to installation SOP. Tell the soldier to assume the prone supported or supported fighting position. Tell him you are evaluating his ability to place effective fire on targets using the M16-series rifle equipped with the AN/PAS-13 thermal weapon sight.

Performance Measures	GO	NO GO
1. Placed TWS into operation.	___	___
2. Assumed an appropriate firing position based on the situation.	___	___
3. Identified targets in the designated sector of fire.	___	___
4. Loaded the weapon.	___	___
5. Acquired targets using TWS reticle.	___	___
6. Fired on target(s) until they were destroyed or until the order to cease fire was received.	___	___

**Evaluation Guidance:** Score the soldier GO if all performance measures are passed. Score the soldier NO GO if any performance measure is failed. If the soldier scores NO GO, show him what was done wrong and how to do it correctly.

---

**References****Required****Related**

FM 21-75

TM 11-5855-309-12&amp;P

---

**071-311-2025****Maintain an M16-Series Rifle**

**Conditions:** Given an M16-series rifle, magazine, 5.56-mm ammunition, small-arms maintenance equipment case, and lubricating instructions. You have the following cleaning materials: swabs, pipe cleaner, cleaner lubricant preservative (CLP). You also have lubricating oil, semifluid, weapons; lubricating oil, arctic weapons; and rifle bore cleaner.

**Standards:** Cleaned, inspected, and lubricated the rifle and magazine so they functioned correctly. Cleaned and inspected the ammunition. Turned in any unserviceable ammunition.

---

**Performance Steps**

---

1. Clear the rifle.
    - a. Remove the magazine from the rifle if there is one present.
    - b. Cock the rifle.
    - c. Turn the selector to SAFE (figure 071-311-2025-1).
-

---

Performance Steps

---

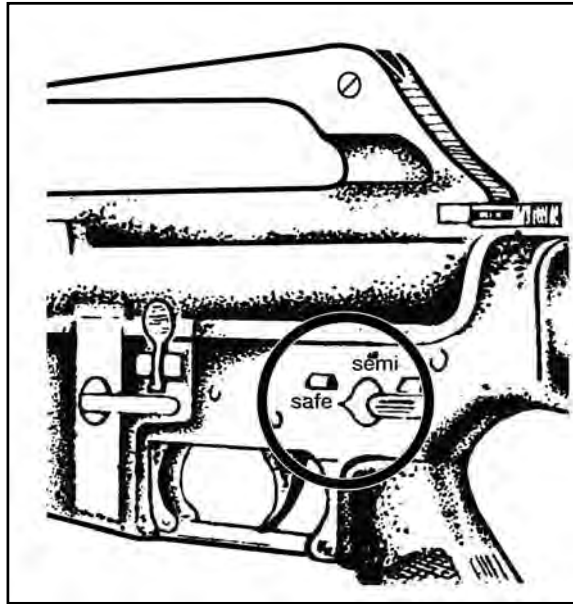


Figure 071-311-2025-1. Selector lever on safe

**Note.** The selector cannot be turned to SAFE unless the rifle is cocked.

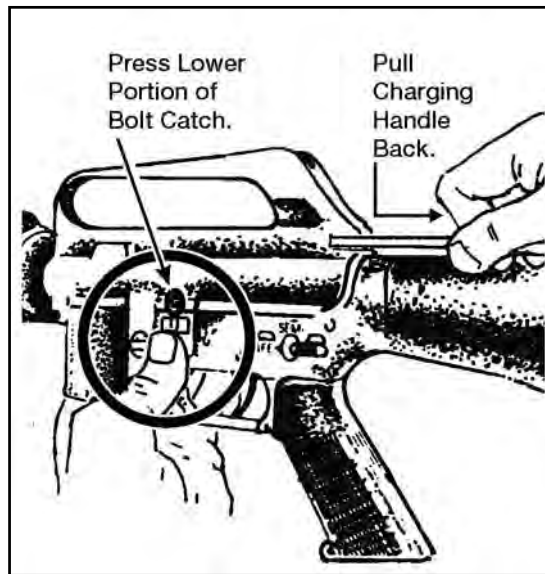
**d.** Lock the bolt open (figure 071-311-2025-2).

---

---

**Performance Steps**

---



**Figure 071-311-2025-2. Locking the bolt open**

- (1) Pull the charging handle rearward.
- (2) Press the bottom of the bolt catch.
- (3) Allow the bolt to move forward until it engages the bolt catch.
- (4) Return the charging handle to the forward position.
- (5) Ensure the selector is on SAFE.

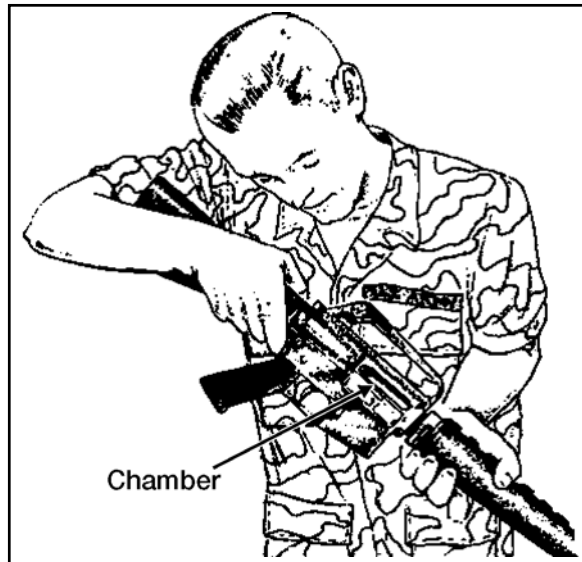
**e.** Inspect the receiver and chamber to ensure they do not contain ammunition (figure 071-311-2025-3).

---

---

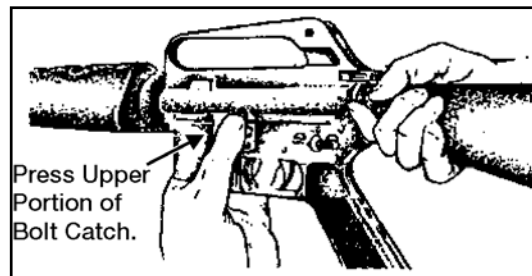
**Performance Steps**

---



**Figure 071-311-2025-3. Inspecting the chamber**

- f. Allow the bolt to go forward by pressing the upper portion of the bolt catch (figure 071-311-2025-4).



**Figure 071-311-2025-4. Releasing the bolt**

- 2. Disassemble the rifle.
  - a. Verify the rifle is clear.
  - b. Remove the sling.



---

**Performance Steps**

---

c. Remove the handguards if you can see dirt or corrosion through the vent holes (figure 071-311-2025-5). Handguards on the M16A2 are interchangeable because they are identical.

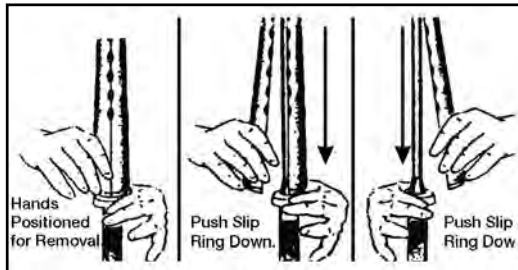


Figure 071-311-2025-5. Removing the handguards

**WARNING**

Use care to avoid bending or denting the gas tube while removing the handguards.

d. Push the takedown pin as far as it will go and pivot the upper receiver from the lower receiver (figure 071-311-2025-6).

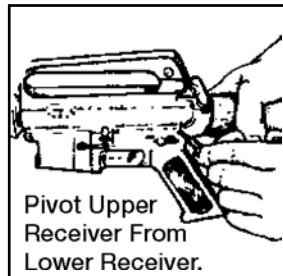


Figure 071-311-2025-6. Pushing the takedown pin

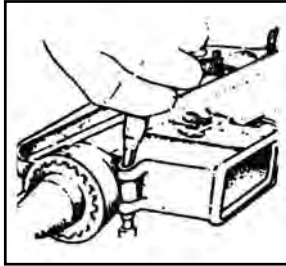
e. Push the receiver pivot pin (figure 071-311-2025-7).

---

---

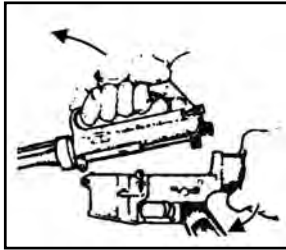
**Performance Steps**

---



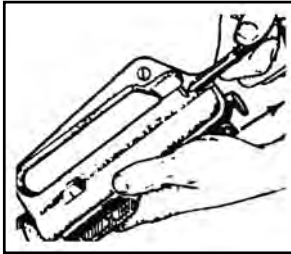
**Figure 071-311-2025-7. Pushing the receiver pivot pin**

- f. Separate the upper and lower receivers (figure 071-311-2025-8).



**Figure 071-311-2025-8. Separating the upper and lower receivers**

- g. Pull back the charging handle (figure 071-311-2025-9).



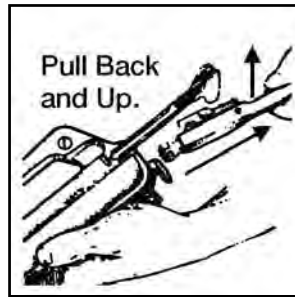
**Figure 071-311-2025-9. Pulling the charging handle**

- h. Remove the bolt carrier and bolt (figure 071-311-2025-10).
-

---

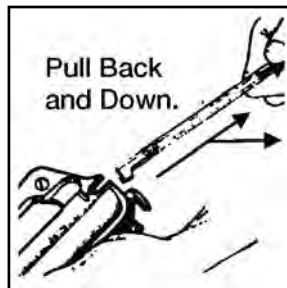
**Performance Steps**

---



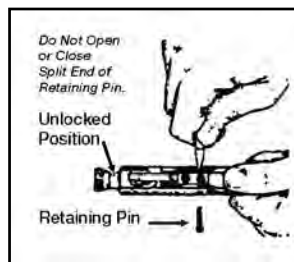
**Figure 071-311-2025-10. Removing the bolt carrier and bolt**

- i. Remove the charging handle (figure 071-311-2025-11).



**Figure 071-311-2025-11. Removing the charging handle**

- j. Remove the firing pin retaining pin (figure 071-311-2025-12).



**Figure 071-311-2025-12. Removing the firing pin retaining pin**

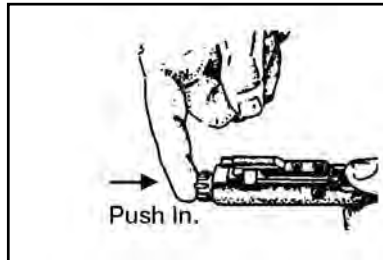
---

---

**Performance Steps**

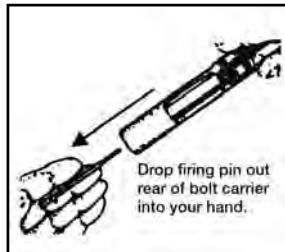
---

**k.** Put the bolt assembly in the locked position by pushing in the bolt (figure 071-311-2025-13).



**Figure 071-311-2025-13. Bolt in the locked position**

**l.** Remove the firing pin by allowing it to drop out of the rear of the bolt carrier into your hand (figure 071-311-2025-14).



**Figure 071-311-2025-14. Removing the firing pin**

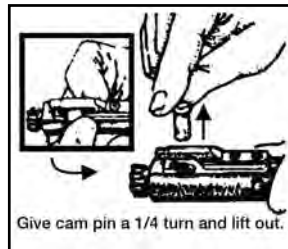
**m.** Remove the bolt cam pin by turning it one-quarter turn and lifting it out (figure 071-311-2025-15).

---

---

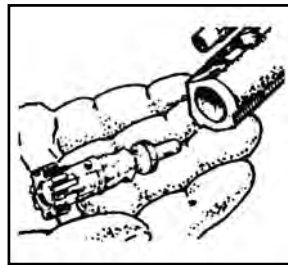
**Performance Steps**

---



**Figure 071-311-2025-15. Removing the bolt cam pin**

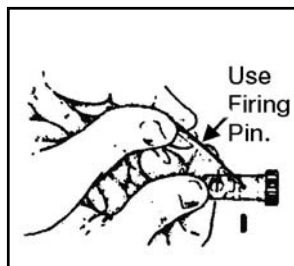
n. Pull the bolt assembly from the carrier (figure 071-311-2025-16).



**Figure 071-311-2025-16. Removing the bolt assembly**

**Note.** Perform steps o through r when the parts are dirty or damaged.

o. Remove the extractor pin by pushing it out with the firing pin (use care not to damage the firing pin) (figure 071-311-2025-17).



**Figure 071-311-2025-17. Removing the extractor pin**

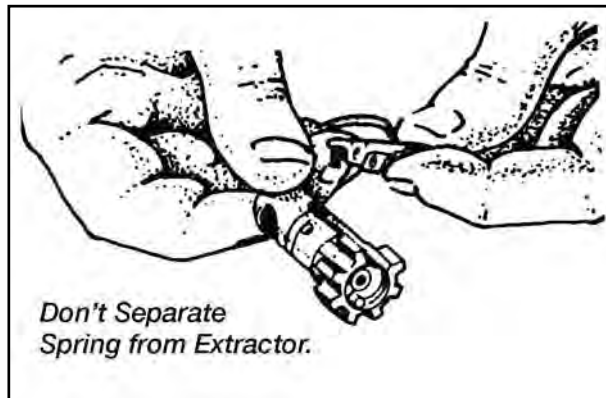
---

---

**Performance Steps**

---

**p.** Lift out the extractor and spring (figure 071-311-2025-18), taking care so the spring does not separate from the extractor.

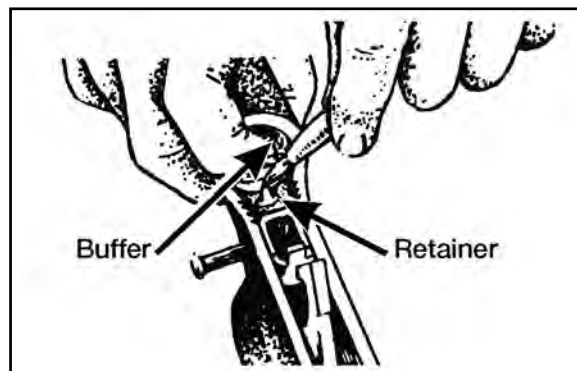


**Figure 071-311-2025-18. Removing the extractor and spring**

**Note.** Press the top of the extractor to check spring function.

**q.** Release the buffer by pressing the buffer and depressing the retainer.

**r.** Remove the buffer and action spring separating the buffer from the spring (figure 071-311-2025-19 and figure 071-311-2025-20).



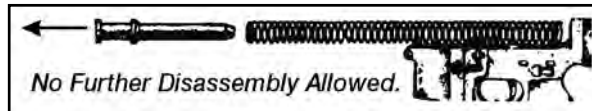
**Figure 071-311-2025-19. Separating the buffer and spring**

---

---

**Performance Steps**

---



**Figure 071-311-2025-20. Separating the buffer and spring (continued)**

**s.** Do not disassemble the rifle further.

**3.** Clean the rifle by removing carbon buildup and lubricating according to lubrication instructions. Make sure you remove any excessive oil from the bore before firing.

**Note.** After firing ball or blank ammunition, clean the weapon one time only with CLP. Under all but the coldest arctic conditions, use only CLP to lubricate the rifle.

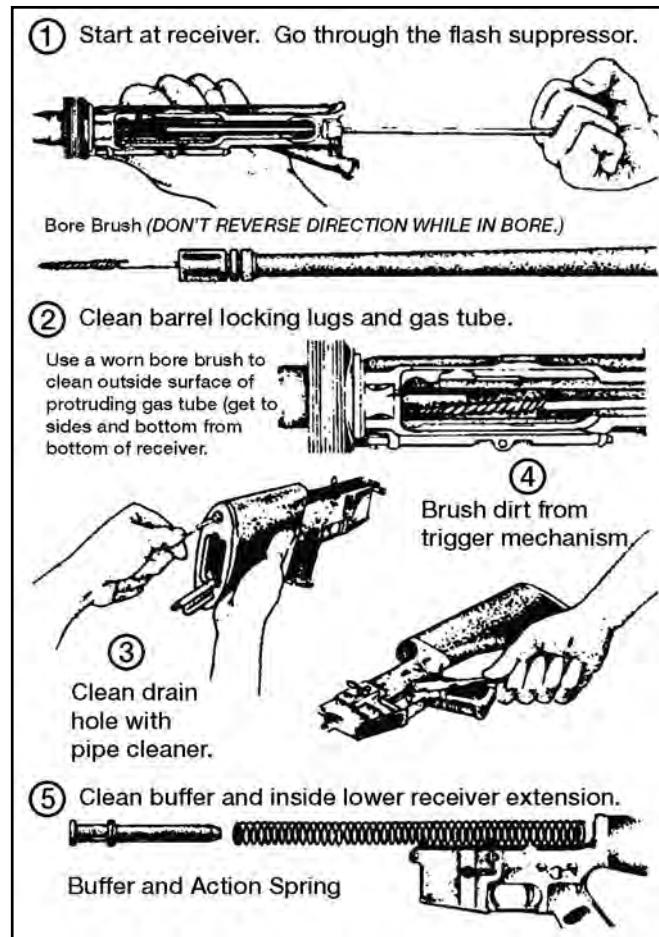
**a.** Clean the upper and lower receiver group using CLP to remove powder fouling in the upper receiver (figure 071-311-2025-21).

---

---

**Performance Steps**

---



**Figure 071-311-2025-21. Cleaning the receivers**

**b.** Clean the bolt carrier group, wiping the following parts with swabs and other parts from the small-arms maintenance equipment case (figure 071-311-2025-22).

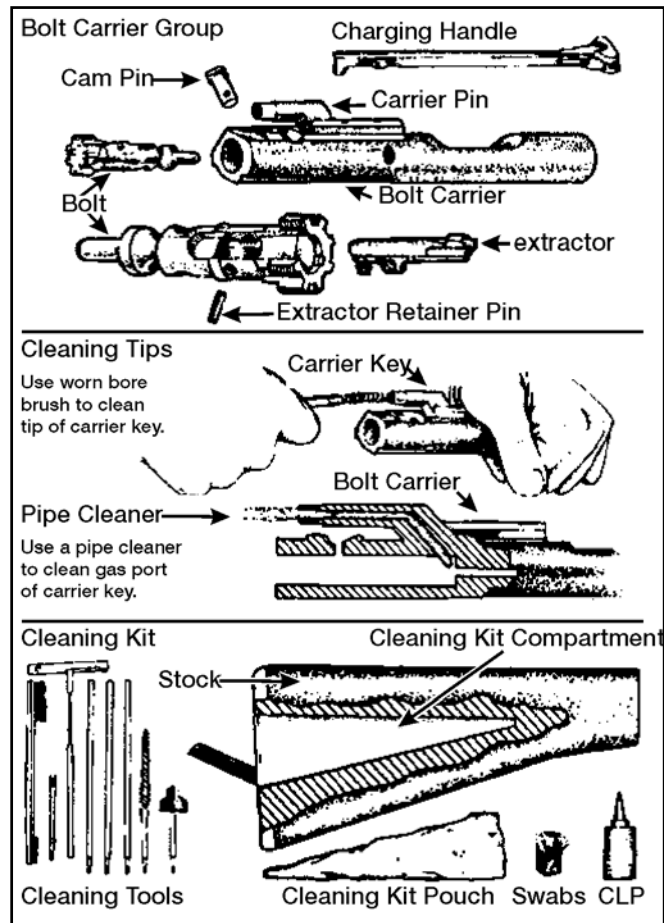
---



---

**Performance Steps**

---



**Figure 071-311-2025-22. Cleaning the bolt carrier group**

- (1) The outer and inner surfaces of the bolt carrier.
  - (2) The carrier key.
  - (3) The firing pin recess and firing pin.
  - (4) The firing pin hole with a pipe cleaner.
  - (5) The carbon deposits and dirt from the locking lugs.
-

---

**Performance Steps**

---

(6) The areas behind the bolt ring and under the lip of the extractor.

c. Clean the following rifle parts, lightly lubricating with CLP (figure 071-311-2025-22).

(1) Lugs in the barrel extension, bore, and chamber.

(2) Bolt carrier.

(3) Slide cam pin area.

(4) Piston rings.

(5) Outside the bolt body.

(6) Inside the bolt carrier key.

(7) Firing pin and firing pin recess.

(8) Outside surface of the protruding gas tube with a worn bore brush.

(9) Buffer.

(10) Action spring.

(11) Inner surfaces of the lower receiver extension.

(12) Inside the lower receiver.

(13) All other components.

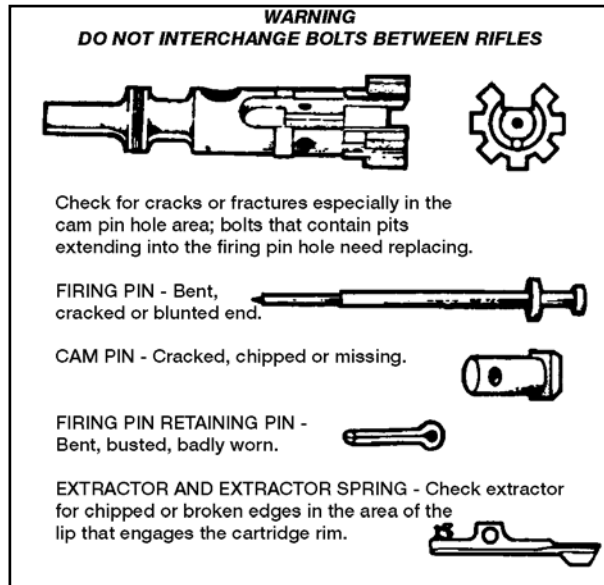
**4.** Inspect disassembled rifle bolt assembly (figure 071-311-2025-23).

---

---

**Performance Steps**

---



**Figure 071-311-2025-23. Inspecting the bolt assembly**

- a. Identify defective or missing components.
- b. Report deficiencies to the armorer.

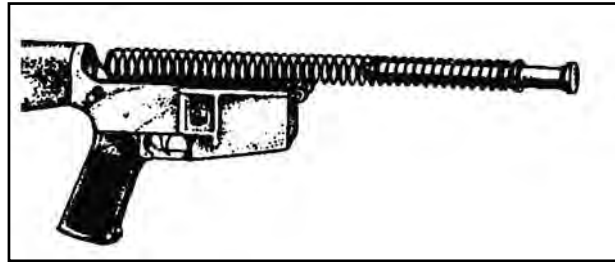
**WARNING**  
Do not interchange bolts between rifles.

5. Assemble the rifle.
    - a. Insert the spring and buffer (figure 071-311-2025-24).
-

---

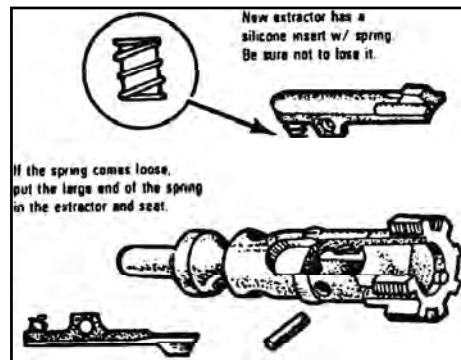
**Performance Steps**

---



**Figure 071-311-2025-24. Placing the spring and buffer**

**b. Insert the extractor and spring (figure 071-311-2025-25).**



**Figure 071-311-2025-25. Placing the extractor and spring**

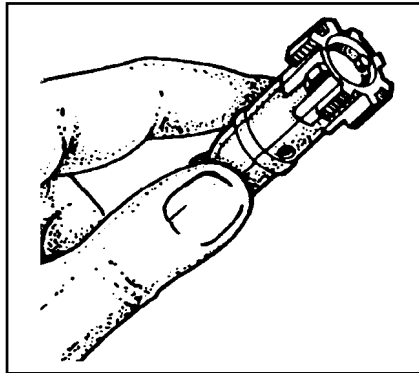
**c. Push the extractor pin in (figure 071-311-2025-26).**

---

---

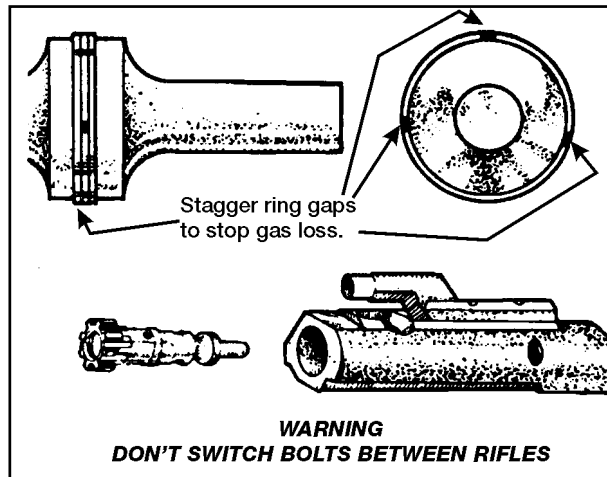
**Performance Steps**

---



**Figure 071-311-2025-26. Holding the extractor pin in**

**d.** Slide the bolt into the carrier until the bolt cam pin hole in both the bolt carrier and the bolt are aligned (figure 071-311-2025-27).



**Figure 071-311-2025-27. Placing the bolt in the carrier**

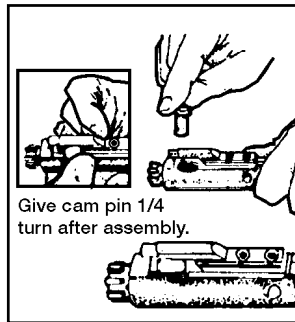
**e.** Place the bolt cam pin by putting it in the bolt carrier, turning it one-quarter turn (figure 071-311-2025-28).

---

---

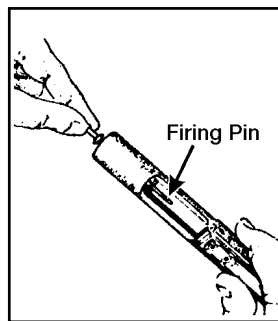
**Performance Steps**

---



**Figure 071-311-2025-28. Replacing the bolt cam pin**

- f. Drop in the firing pin to seat it (figure 071-311-2025-29).



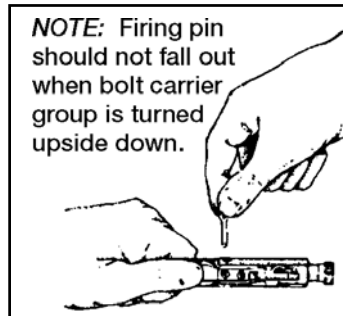
**Figure 071-311-2025-29. Placing the firing pin**

- g. Put the firing pin retaining pin in the bolt carrier to seat it (figure 071-311-2025-30).
-

---

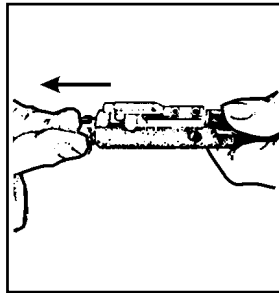
**Performance Steps**

---



**Figure 071-311-2025-30. Placing the firing pin retaining pin**

**h. Pull the bolt back (figure 071-311-2025-31).**



**Figure 071-311-2025-31. Pulling back on the bolt**

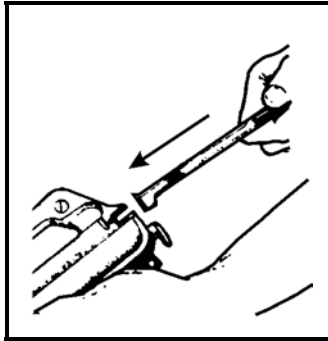
**i. Place the charging handle by engaging it, then pushing the charging handle part of the way in (figure 071-311-2025-32).**

---

---

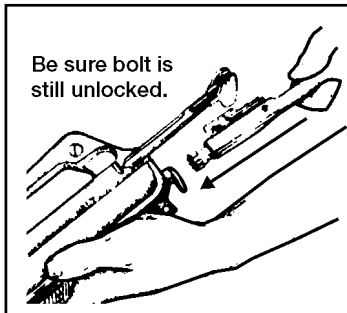
**Performance Steps**

---



**Figure 071-311-2025-32. Placing the charging handle in the receiver**

- j. Slide the bolt carrier into the upper receiver (figure 071-311-2025-33).



**Figure 071-311-2025-33. Placing the bolt carrier**

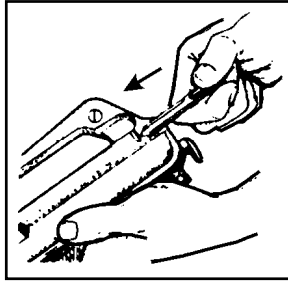
- k. Push the charging handle and bolt carrier together in the upper receiver (figure 071-311-2025-34).
-



---

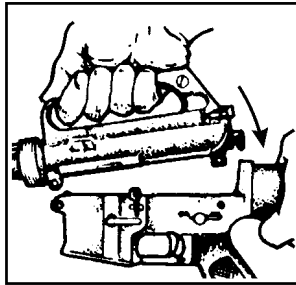
**Performance Steps**

---



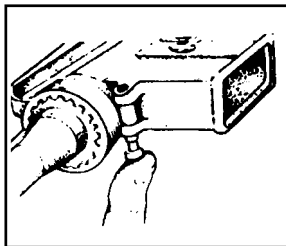
**Figure 071-311-2025-34. Placing the charging handle and the bolt carrier**

- I. Join the upper and lower receiver (figure 071-311-2025-35).



**Figure 071-311-2025-35. Joining the upper and lower receivers**

- m. Engage the receiver pivot pin (figure 071-311-2025-36).



**Figure 071-311-2025-36. Engaging the receiver pivot pin**

**CAUTION**

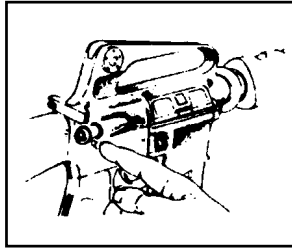
The selector lever must be on SAFE before closing the upper receiver.

---

**Performance Steps**

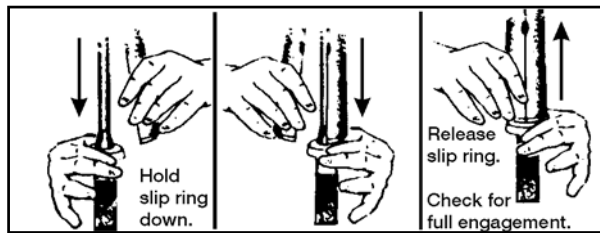
---

- n. Close the upper and lower receiver groups, seating the takedown pin and ensuring the selector switch is on SAFE (figure 071-311-2025-37).



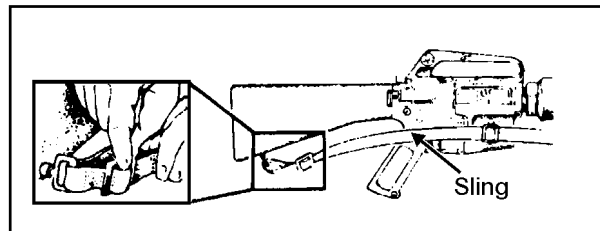
**Figure 071-311-2025-37. Seating the takedown pin**

- o. Put the handguards in place (figure 071-311-2025-38).



**Figure 071-311-2025-38. Placing the handguards**

- p. Replace the sling (figure 071-311-2025-39).



**Figure 071-311-2025-39. Placing the sling**

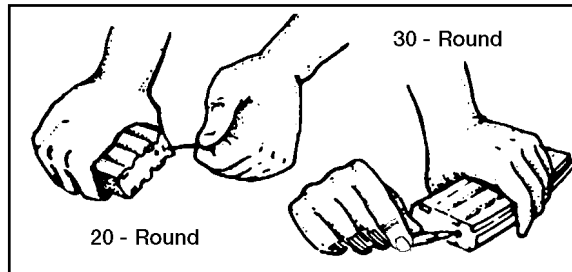
- 6. Disassemble the magazine without removing the follower from the spring.

- a. Release the base catch (figure 071-311-2025-40).

---

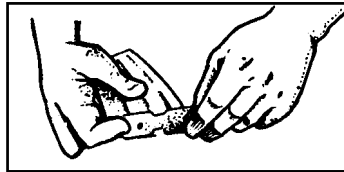
**Performance Steps**

---



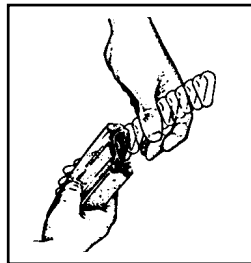
**Figure 071-311-2025-40. Releasing the base catch of the magazine**

- b.** Remove the base (figure 071-311-2025-41).



**Figure 071-311-2025-41. Removing the base of the magazine**

- c.** Remove the spring and follower by jiggling them (figure 071-311-2025-42).



**Figure 071-311-2025-42. Removing the magazine spring and the follower**

- 7.** Clean the magazine.
- a.** Wipe the dirt from the tube, spring, and follower.
  - b.** Lubricate the spring lightly.
- 8.** Assemble the magazine.
-

---

**Performance Steps**

---

- a. Jiggle the spring and follower together to install them in the magazine.
  - b. Slide the base under all four tabs, making sure the print is on the outside.
9. Clean the ammunition using a clean, dry cloth to wipe dirt and foreign matter from the ammunition. Do not coat with oil.
- 

**Evaluation Preparation:**

*Setup:* Have soldier use his own rifles and magazines. Provide swabs, CLP, pipe cleaners, and, if available, preservative lubricant (PL), special lubricating oil, and rifle bore cleaner (RBC). (The soldier should not select the PL, special lubricating oil, or RBC for use.) Also, provide several rounds of dummy ammunition, if available.

**Brief Soldier:** Tell the soldier to clean, inspect, and lubricate the rifle and magazine following normal safety practices.

Performance Measures	GO	NO GO
1. Cleared the rifle before disassembly.	___	___
a. Removed the magazine from the rifle.		
b. Cocked the rifle.		
c. Turned the selector to SAFE.		
d. Locked the bolt open.		
e. Checked the receiver and chamber to ensure they did not contain ammunition.		
f. Allowed the bolt to go forward by pressing the upper portion of the bolt catch.		
2. Disassembled the rifle.	___	___
a. Verified the rifle was clear.		
b. Removed the sling.		
c. Removed the handguards if dirt or corrosion could be seen through the vent holes.		
d. Pushed the takedown pin as far as it would go and pivoted the upper receiver from the lower receiver.		
e. Pushed the receiver pivot pin.		
f. Separated the upper and lower receivers.		
g. Pulled back the charging handle.		

<b>Performance Measures</b>	<b>GO</b>	<b>NO GO</b>
<b>h.</b> Removed the bolt carrier and bolt.		
<b>i.</b> Removed the charging handle.		
<b>j.</b> Removed the firing pin retaining pin.		
<b>k.</b> Put the bolt assembly in the locked position by pushing in the bolt.		
<b>l.</b> Removed the firing pin by allowing it to drop out of the rear of the bolt carrier into hand.		
<b>m.</b> Removed the bolt cam pin by turning it one-quarter turn and lifting it out.		
<b>n.</b> Pulled the bolt assembly from the carrier.		
<b>o.</b> Removed the extractor pin by pushing it out with the firing pin.		
<b>p.</b> Lifted out the extractor and spring, taking care so the spring did not separate from the extractor.		
<b>q.</b> Released the buffer by pressing the buffer and depressing the retainer.		
<b>r.</b> Removed the buffer and action spring separating the buffer from the spring.		
<b>3.</b> Cleaned the rifle using the correct materials.	___	___
<b>a.</b> Cleaned the upper and lower receiver group.		
<b>b.</b> Cleaned the bolt carrier group.		
<b>c.</b> Cleaned all other rifle parts lubricating the rifle with CLP.		
<b>4.</b> Inspected for unserviceable parts.	___	___
<b>a.</b> Identified the defective or missing components.		
<b>b.</b> Reported deficiencies to the armorer.		
<b>5.</b> Assembled the rifle.	___	___
<b>a.</b> Inserted the spring and buffer.		
<b>b.</b> Inserted the extractor and spring.		
<b>c.</b> Pushed the extractor pin in.		
<b>d.</b> Slid the bolt into the carrier until the bolt cam pin hole in both the bolt carrier and the bolt were aligned.		
<b>e.</b> Placed the bolt cam pin by putting it in the bolt carrier, turning it one-quarter turn.		

Performance Measures	GO	NO GO
f. Dropped in the firing pin to seat it.		
g. Put the firing pin retaining pin in the bolt carrier.		
h. Pulled the bolt back.		
i. Placed the charging handle by engaging it, then pushed the charging handle part of the way in.		
j. Slid the bolt carrier into the upper receiver.		
k. Pushed the charging handle and bolt carrier together in the upper receiver.		
l. Joined the upper and lower receiver.		
m. Engaged the receiver pivot pin.		
n. Closed the upper and lower receiver groups.		
o. Put the handguards in place.		
p. Replaced the sling.		
6. Disassembled the magazine without removing the follower from the spring.	___	___
a. Released the base catch.		
b. Removed the base.		
c. Removed the spring and follower.		
7. Cleaned the magazine.	___	___
a. Wiped the dirt from the tube, spring, and follower.		
b. Lubricated the spring lightly.		
8. Assembled the magazine.	___	___
a. Jiggled the spring and follower together to install them in the magazine.		
b. Slid the base under all four tabs, making sure the printed portion was on the outside.		
9. Cleaned the ammunition.	___	___

**Evaluation Guidance:** Score the soldier GO if all performance measures are passed. Score the soldier NO GO if any performance measure is failed. If the soldier scores NO GO, show him what was done wrong and how to do it correctly.

**References**

**Required**

FM 23-9

TM 9-1005-249-10

**Related**

---

**071-311-2027**

**Load an M16-Series Rifle**

**Conditions:** Given an unloaded M16-series rifle with a magazine loaded with ammunition.

**Standards:** Loaded an M16A1 rifle in the semiautomatic and automatic modes or loaded an M16A2 or M16A4 rifle in both the semiautomatic and burst modes. In either case, ensured that a round was chambered and the selector was returned to the SAFE position.

---

**Performance Steps**

1. Determine the mode in which the rifle will be operated by using table 071-311-2027-1.

ONLY A1	BURST EQP WEAPONS	OPERATING MODE	SELECTOR POSITION	RIFLE WILL
X	X	Safe	SAFE	Not fire.
X	X	Semiautomatic	SEMI	Fire 1 round each time the trigger is pulled.
X		Automatic	AUTO	Fire as long as the trigger is held down or the ammo lasts.
	X	Burst	BURST	Fire a 3-round burst each time the trigger is pulled.

**Table 071-311-2027-1. M16 family operating modes.**

2. Prepare the M16A1, M16A2, or M16A4 rifle for semiautomatic fire and the M16A1 rifle for automatic fire.
  - a. Point the rifle muzzle in a safe direction.
  - b. Cock the rifle (this also opens the bolt).

---

**Performance Steps**

---

- c. Return the charging handle to the forward position.
- d. Place the selector lever on SAFE (figure 071-311-2027-1).

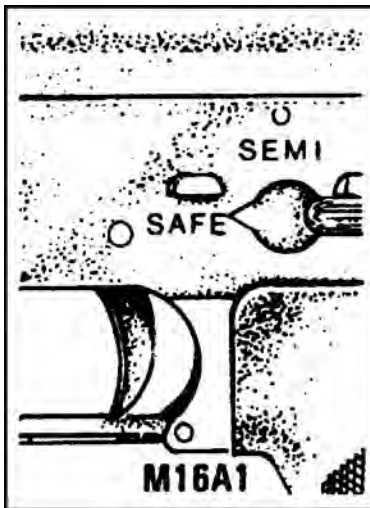


Figure 071-311-2027-1. Selector lever on SAFE.

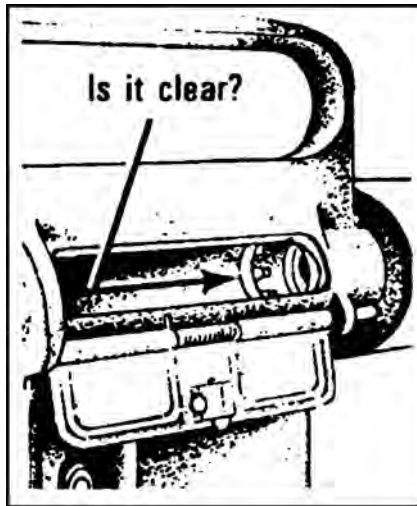
- e. Check the chamber to ensure it is clear (figure 071-311-2027-2).



---

**Performance Steps**

---



**Figure 071-311-2027-2. Inspecting the chamber.**

- f. Insert the magazine, pushing it upward until the magazine catch engages and holds the magazine (figure 071-311-2027-3).

---

Performance Steps

---

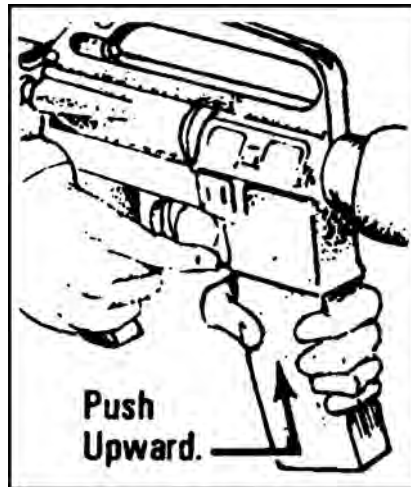


Figure 071-311-2027-3. Magazine inserted.

**g.** Tap upward on the bottom of the magazine to ensure it is seated.

**Note:** The magazine may be loaded with the bolt assembly open or closed.

**3.** Prepare the M16A2 or M16A4 rifle for burst fire.

**a.** Point the rifle muzzle in a safe direction.

**b.** Cock the rifle (this also opens the bolt).

**c.** Return the charging handle to the forward position.

**d.** Place the selector lever in the BURST position (figure 071-311-2027-4).

---

Performance Steps

---

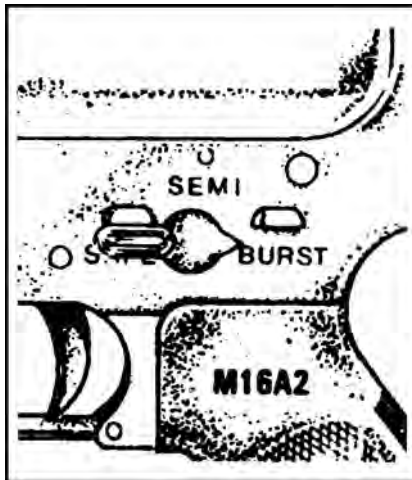


Figure 071-311-2027-4. Selector lever on BURST.

- e. Pull the trigger, holding it in the rear position.
- f. Pull the charging handle to the rear and release it (figure 071-311-2027-5).

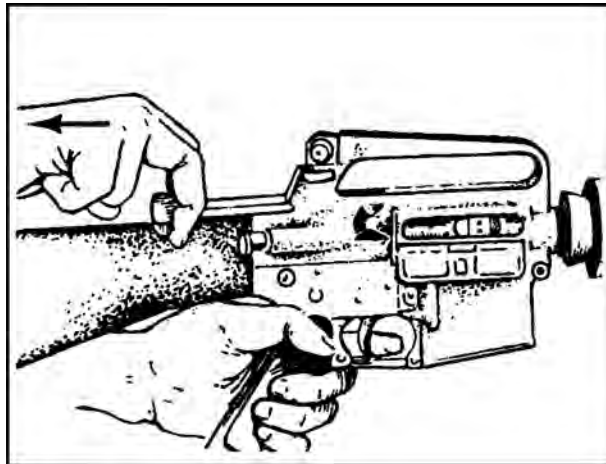


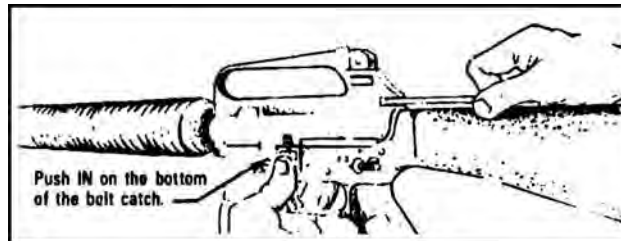
Figure 071-311-2027-5. Charging handle.

---

**Performance Steps**

---

- g.** Repeat step 3f three times.
- h.** Pull the charging handle to the rear, holding it in place.
- i.** Release the trigger.
- j.** Push in on the bottom portion of the bolt catch, locking the bolt in the rear position (figure 071-311-2027-6).



**Figure 071-311-2027-6. Bolt locked to the rear.**

- k.** Slide the charging handle all the way forward.
  - l.** Place the selector on SAFE.
  - m.** Insert the magazine, pushing it upward until the magazine catch engages and holds the magazine (figure -).
  - n.** Tap upward on the bottom of the magazine to ensure it is seated.
- 4. Chamber a round.**
- a.** With the bolt open:
    - (1)** Depress the upper portion of the bolt catch to release the bolt (figure 071-311-2027-7).

---

Performance Steps

---

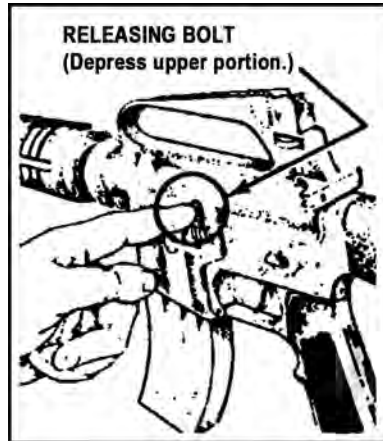


Figure 071-311-2027-7. Bolt catch.

(2) Tap the forward assist to ensure that the bolt is fully forward and locked (figure 071-311-2027-8).

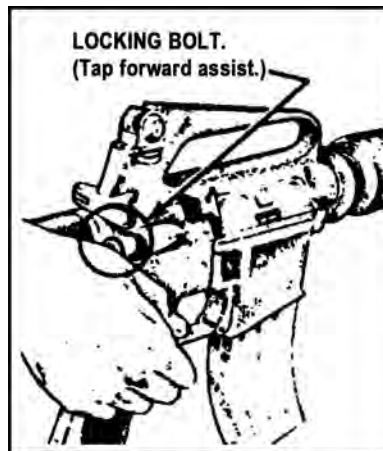


Figure 071-311-2027-8. Forward assist.

---

**Performance Steps**

---

**WARNING**

The rifle is now loaded. Ensure it is pointed in a safe direction.

(3) Place selector lever on SAFE, closing the ejection port cover if the rifle is not to be fired immediately.

b. With the bolt closed:

(1) Pull the charging handle to the rear as far as it will go.

(2) Release the charging handle. Do not ride the charging handle; allow it to return on its own.

(3) Tap the forward assist to ensure the bolt is fully forward and locked.

**WARNING**

The rifle is now loaded. Ensure it is pointed in a safe direction.

(4) Place the selector lever on SAFE closing the ejection port cover if the rifle is not to be fired immediately.

**Evaluation Preparation:**

*Setup:* Have soldiers use their assigned rifles and magazines. Provide blank or dummy ammunition when evaluating this task.

*Brief Soldier:* Tell the soldier to load the rifle using the steps appropriate for the model being used. An M16A2 rifle must be loaded in both the semiautomatic and BURST modes.

<b>Performance Measures</b>	<b>GO</b>	<b><u>NO GO</u></b>
<b>Note:</b> Perform steps 1 and 3 through 5 for the M16A1 rifle and steps 1 through 5 for the M16A2 or M16A4 rifle.		
1. Prepared the M16A1, M16A2, or M16A4 rifle for semiautomatic fire and the M16A1 rifle for automatic fire; ensured the chamber was cleared and the magazine was seated.	—	—
2. Prepared the M16A2 or M16A4 rifle for burst fire; ensured the magazine was seated.	—	—

Performance Measures	GO	NO GO
3. Chambered a round; ensured the bolt was fully forward and locked.	___	___
4. Pointed the rifle in a safe direction.	___	___
5. Placed the selector lever in the SAFE position.	___	___

**Evaluation Guidance:** Score the soldier GO if all performance measures are passed. Score the soldier NO-GO if any performance measure is failed. If the soldier scores NO-GO, show the soldier what was done wrong and how to do it correctly.

#### References

##### Required

TM 9-1005-249-10

TM 9-1005-319-10

##### Related

---

## 071-311-2028

### Unload an M16-Series Rifle

**Conditions:** Given a loaded M16-series rifle from which you must remove the ammunition.

**Standards:** Cleared the rifle, removed all ammunition and secured the rifle in the SAFE mode.

---

#### Performance Steps

1. Point the rifle muzzle in a safe direction.
2. Remove the magazine from the rifle.
3. Place the selector lever on SAFE.
4. Lock the bolt open.
  - a. Pull the charging handle rearward.
  - b. Press the bottom of the bolt catch.
  - c. Return the charging handle to the forward position.
5. Remove any ammunition from the receiver and chamber.
6. Press the upper portion of the bolt catch, allowing the bolt to go

---

**Performance Steps**

---

forward.

7. Pull the trigger to release the pressure on the firing pin spring.

**Evaluation Preparation:**

*Setup:* At a test site, provide an M16-series rifle loaded with dummy ammunition. (You can also evaluate the soldier using his individual rifle if loaded. Do not require the soldier to pull the trigger after releasing the bolt.)

*Brief Soldier:* Tell the soldier to unload the rifle.

<b>Performance Measures</b>	<b>GO</b>	<b><u>NO GO</u></b>
1. Pointed the rifle muzzle in a safe direction.	___	___
2. Removed the magazine from the rifle.	___	___
3. Placed the selector lever on SAFE.	___	___
4. Locked the bolt open.	___	___
a. Pulled the charging handle rearward.		
b. Pressed the bottom of the bolt catch.		
c. Returned the charging handle to the forward position.		
5. Removed any ammunition from the receiver and chamber.	___	___
6. Pressed the upper portion of the bolt catch, allowed the bolt to go forward.	___	___
7. Pulled the trigger to release the pressure on the firing pin spring.	___	___

**Evaluation Guidance:** Score the soldier GO if all performance measures are passed. Score the soldier NO-GO if any performance measure is failed. If the soldier scores NO-GO, show the soldier what was done wrong and how to do it correctly.

**References****Required**

TM 9-1005-249-10

3-312

**Related**

071-311-2028



---

## 071-315-2308

### Engage Targets with an M16-Series Rifle Using a Night Vision Sight AN/PVS-4

**Conditions:** During darkness, given an M16-series rifle with a mounted and zeroed AN/PVS-4; one silhouette target between 50 and 100 meters, one at 150 meters, and one between 200 and 250 meters; and one magazine with 18 rounds of ammunition.

**Standards:** Fired all 18 rounds and hit the targets at least nine times. At least five rounds hit the 150-meter target; at least two rounds hit the 50- to 100-meter target, and at least two rounds hit the 200- to 250-meter target.

---

#### Performance Steps

**Note.** Ensure the AN/PVS-4 has the proper sighting reticle (figure 071-315-2308-1).

1. Place the sight into operation.
2. Use the sight reticle. When used with the rifle, the AN/PVS-4 sight reticle consists of two parts (figure 071-315-2308-1).
  - a. Use the upper part of the reticle (range scale) to determine range to the target.
  - b. Use the lower part of the reticle for aiming the weapon.

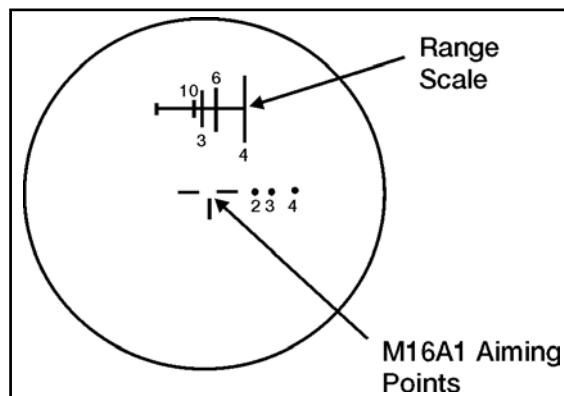


Figure 071-315-2308-1. Sight reticle

---

**Performance Steps**

---

**Note.** Ensure the AN/PVS-4 is mounted to the rifle using the rifle mounting adapter and not the M203 mounting bracket.

**3. Determine range to target.**

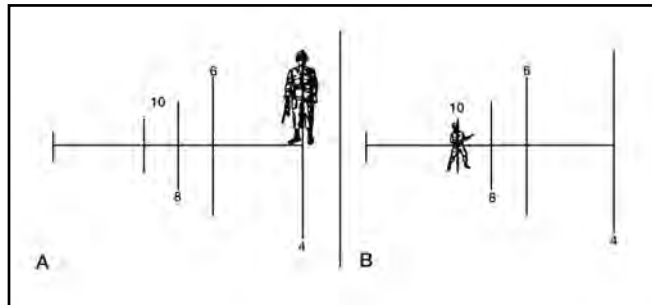
**a.** The vertical lines on the range scale tell the distance from a 6-foot man.

**(1)** Place the target on the horizontal line and match it with one of the vertical lines (A, figure 071-315-2308-2).

**(2)** Read the number at the bottom or top of the vertical line. That is the distance in hundreds of meters to the target.

**(3)** If the figure is the same height as the vertical line above and below the horizontal line, the distance will be half the number at the top or bottom of that line (B, figure 071-315-2308-2).

**(4)** The man shown in A, figure 071-315-2308-2 is 400 meters away. The man in B, figure 071-315-2308-2 is 500 meters away.



**Figure 071-315-2308-2. Range determination using vertical lines**

**b.** The horizontal line of the range scale indicates the range (in hundreds of meters) of a 20-foot target such as a tank or large truck viewed from the side.

**(1)** Place the left edge of the vehicle at the left side of the horizontal line (figure 071-315-2308-3).

**(2)** Read the range to the tank from the scale at the right edge of the tank. As shown in A, figure 071-315-2308-3, the range to the vehicle is 1,000 meters.

---

---

**Performance Steps**

---

(3) When viewed from the front or rear, the vehicle width is about half the length. Read the placement of the vehicle width on the range scale as half the range scale value. As shown in B, figure 071-315-2308-3, the range to the vehicle is 400 meters.

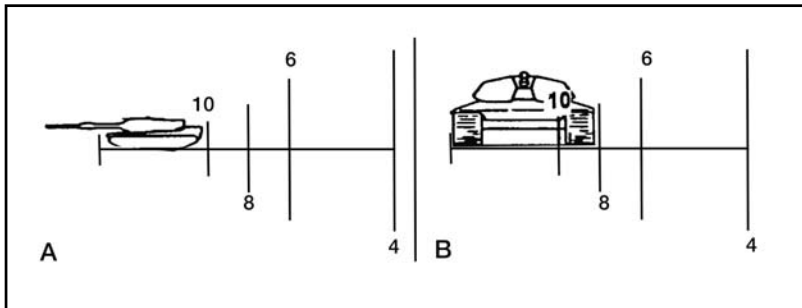


Figure 071-315-2308-3. Range determination using horizontal lines

4. Engage targets using the sight reticle.

a. The rifle aiming point for ranges out to 250 meters is the center of the three straight lines (zero aiming point) (figure 071-315-2308-4). The top of the vertical line is the aiming point for 400 meters, and the bottom of the line is the aiming point for 600 meters.

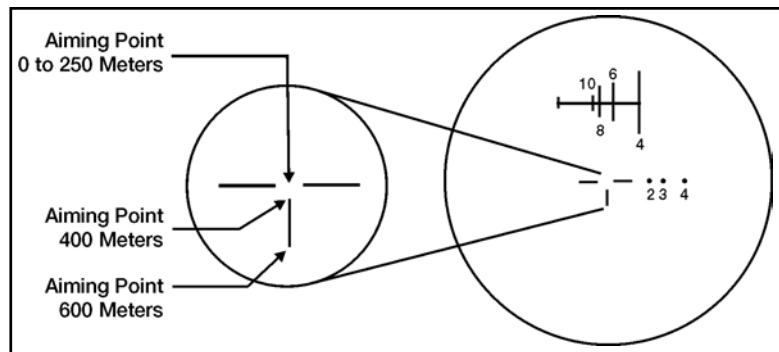


Figure 071-315-2308-4. Zero aiming point

b. Locate the target, estimate the range, and place the proper aiming point on the target.

---

---

**Performance Steps**

---

**WARNING**

To prevent eye injury from weapon recoil, attach the eye guard to the sight before firing the weapon.

c. Fire the weapon using correct marksmanship procedures.

**Note.** When firing the rifle, disregard the three dots to the right of the aiming point; these are needed only when firing the M203.

---

**Evaluation Preparation:**

*Setup:* At a live-fire range, provide the equipment and materials given in the task conditions. Turn off the sight after evaluation.

*Brief Soldier:* Tell the soldier to engage all targets with a minimum of nine hits (to include at least five hits on the 150-meter target and at least two hits on the 50- to 100-meter target, and at least two hits on the 200- to 250-meter target) out of 18 rounds.

Performance Measures	GO	NO GO
1. Placed the AN/PVS-4 into operation.	___	___
2. Engaged targets.	___	___
a. The 150-meter target with at least five hits.		
b. The 50- to 100-meter target with at least two hits.		
c. The 200- to 250-meter target with at least two hits.		

**Evaluation Guidance:** Score the soldier GO if all performance measures are passed. Score the soldier NO GO if any performance measure is failed. If the soldier scores NO GO, show him what was done wrong and how to do it correctly.

**References****Required****Related**

TM 11-5855-213-10

---

---

**SUBJECT AREA 10: M240B MACHINE GUN**

---

**071-000-0005**

**Prepare a Range Card for a Machine Gun**

**Conditions:** During daylight, in a defensive fighting position, given a tripod-mounted machine gun with a traversing and elevation (T&E) mechanism; an assigned primary sector of fire with recognizable targets (either an FPL [final protective line] or PDF [principal direction of fire]); and a secondary sector of fire with recognizable targets; blank standard range cards DA Form 5517-R; a pencil; a lensatic compass; and a map of your assigned sector of fire.

**Standards:** Prepared a range card for your position in duplicate. Sketched in the terrain in your assigned sector of fire. Located and sketched in magnetic north, using the appropriate symbol. Sketched in sector limits, the gun symbol, a FPL or PDF, and dead space. In the DATA SECTION wrote in the weapon, the unit, and other data. Sketched in terrain features that offer likely targets and numbered them in priority. Recorded the range and direction to and the elevation and description of each target.

---

**Performance Steps**

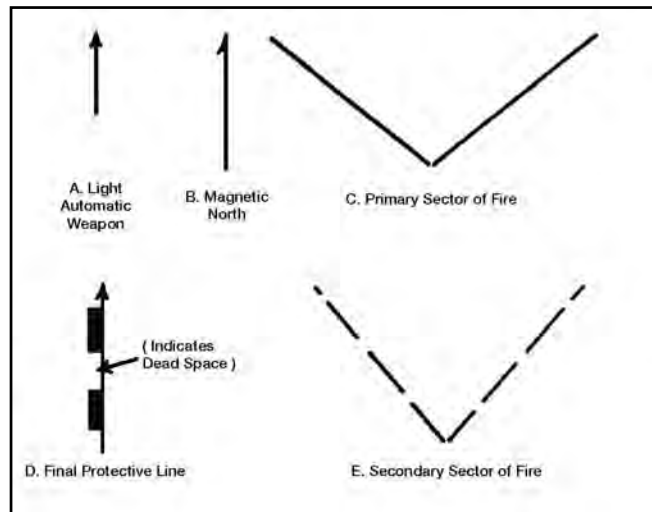
---

1. Show the gunner where to place fires on designated targets during limited visibility conditions such as night, fog, or smoke.
  2. Provide the gunner conducting a relief in place with all the information he needs to respond immediately to enemy action.
  3. Provide the platoon leader and company commander with information they need to plan fires.
  4. Write all necessary information on the range card. Prepare a duplicate range card for the platoon leader. Include on both copies all sketches, symbols (figure 071-000-0005-1) and data.
-

---

**Performance Steps**

---



**Figure 071-000-0005-1. Symbols.**

- a. On the range card, roughly sketch the terrain in front of the position.
    - (1) Center the machine gun position at the bottom of the sketch.
    - (2) Include any prominent natural and man-made features that a target could use to take cover.
  - b. Using the lensatic compass, determine magnetic north.
  - c. Write the following information in the top portion of the range card (figures 071-000-0005-2 and 071-000-0005-3):
-

**Performance Steps**


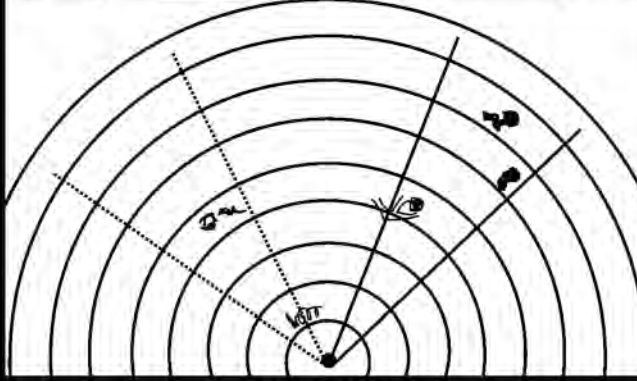



STANDARD RANGE CARD					
For use of this form see FM 7-72. The proponent agency is TRADOC					
SOD <u>20</u>	May be used for all types of direct fire weapons				 MAGNETIC NORTH
PLT <u>20</u>					
CO _____					
DATA SECTION					
POSITION IDENTIFICATION <u>FL93668141</u>			DATE <u>11NOV</u>		
WEAPON <u>M60</u>			EACH CIRCLE EQUALS <u>100</u> METERS		
NO.	DIRECTION/DEFLECTION	ELEVATION	RANGE	AMMO	DESCRIPTION
1	L035	0/24	400		PDF
2	R375	-50/15	625		BARN
3	R175	-50/40	725		HEDGEROW
REMARKS:  TW30/RIT  TW3/L3  TW7/R3					

Figure 071-000-0005-2. Primary sector with principal direction of fire.

**Performance Steps**

STANDARD RANGE CARD					
For use of this form see FM 7-72. The proponent agency is TRADOC					
SOD <u>20</u>	May be used for all types of direct fire weapons				MAGNETIC NORTH
PLT <u>20</u>					
CO _____					
DATA SECTION					
POSITION IDENTIFICATION <u>FL93668141</u>			DATE <u>20 APRIL</u>		
WEAPON <u>M60</u>		EACH CIRCLE EQUALS <u>100</u> METERS			
NO.	DIRECTION/DEFLECTION	ELEVATION	RANGE	AMMO	DESCRIPTION
1	-	+50/3	550		FPL
2	R275	+50/45	525		BARN
3	L102	0/28	425		ROAD JUNCTION
4	L370	0/12	375		BOULDER
REMARKS: <u>0-4</u> <u>0 TW15 / LB</u>					

**Figure 071-000-0005-3. Primary sector with final protective line.**

- (1) SQD. Write in the squad's designation.
- (2) PLT. Write in the platoon's designation.
- (3) CO. Write in the company's designation.
- (4) MAGNETIC NORTH. Sketch the direction for magnetic north using the symbol shown in B, Figure 071-000-0005-1.

**d.** Determine the location of the gun position relative to a prominent



---

**Performance Steps**

---

terrain feature. You could use a hilltop, road junction, or building--in other words, use either a man-made or natural terrain feature.

- (1) Use any terrain feature located within 1,000 meters of the gun.
  - (2) If no such feature exists, then, somewhere near the gun position on the sketch, write in the eight-digit map coordinates for your position (figure 071-000-0005-2).
  - (3) Use a compass to determine the azimuth in mils or degrees from the terrain feature to the gun position or from the gun position to the terrain feature. Compute the back azimuth from the gun to the feature by adding or subtracting 3,200 mils or 180 degrees.
  - (4) Determine the distance between the gun and the feature by pacing or looking at a map.
  - (5) Draw the terrain feature in the lower left- or right-hand corner of the card, whichever better shows the terrain feature's position relative to the gun.
  - (6) Draw a barbed line between the position and the terrain feature.
  - (7) Above the line, record the distance in meters.
  - (8) Below the line, record the azimuth in mils or degrees from the terrain feature to the gun.
  - (9) Use the direction of the arrow's barbs to show the direction of the azimuth.
- e. Sketch in the primary sector of fire (C, figure 071-000-0005-1), using either a PDF or an FDL.
- (1) FPL. Use a FPL (figure 071-000-0005-3 DATA SECTION, Item No. 1) only if the position offers a good grazing distance. Base the primary sector of the line of fire. Make the FPL the sector limit closest to friendly troops.
    - (a) Sketch in the limits of the primary sector of fire.
    - (b) Sketch in a FPL (D, figure 071-000-0005-1) on the sector limit assigned by your leader.
    - (c) Have someone walk the FPL (if the enemy situation permits) to identify and measure dead spaces (section[s] of a FPL where a person drops below the light of sight).
    - (d) Show the dead space(s) on the sketch by a break(s) in the FPL symbol. Write in the ranges to the beginning and end of each dead space(s).
    - (e) Write in the maximum range of graze.
- 
- (2) PDF. If you cannot identify an FPL, you must assign a PDF
-

---

**Performance Steps**

---

(figure 071-000-0005-2 DATA SECTION, Item No.1)

**(a)** Sketch in the limits of the assigned primary sector of fire, whose angle should not exceed 875 mils (the maximum traverse of a tripod-mounted machine gun).

**(b)** Sketch in the symbol for a light automatic weapon (A, figure 071-000-0005-1). Orient the symbol toward the most dangerous target in the sector. Get this information from the platoon leader.

**f.** Label the targets in the primary sector in their order of priority. Label the FPL or PDF with the number "1" (figures 071-000-0005-2 and 071-000-0005-3).

**g.** Sketch in the secondary sector of fire (E, figure 071-000-0005-1).

**(1)** Label the range (in meters) from the gun to each target in the secondary sector.

**(2)** Sketch in aiming and elevation stakes between the gun position and the target as shown in figures 071-000-0005-2 and 071-000-0005-3.

**5.** Using the T&E mechanism, determine the direction, elevation, and range to each target. Write this information in the DATA SECTION of the range card, as follows (figures 071-000-0005-2 and 071-000-0005-3):

**a.** Center the traversing handwheel on the center mark.

**b.** If assigning an FPL, lay the gun for direction. For this step, you will not write anything on the range card.

**(1)** Lock the traversing slide on the extreme left or right side of the bar, depending on which side of the primary sector the FPL is on.

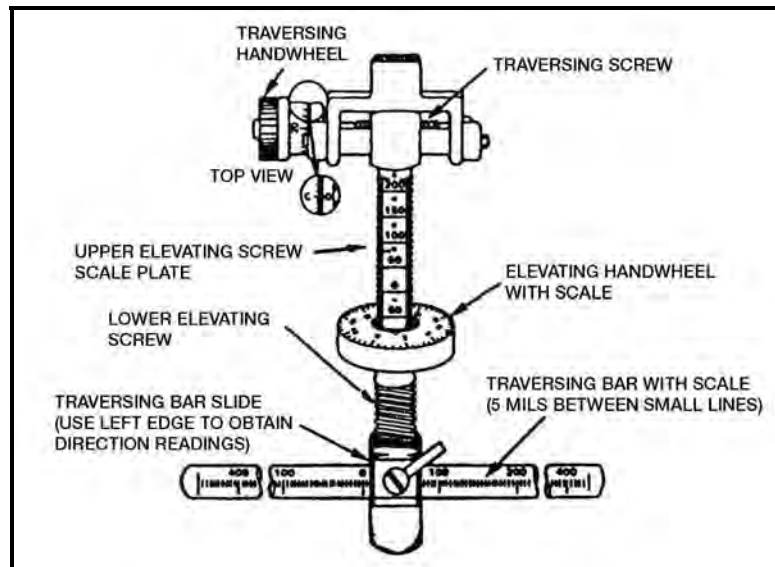
**(2)** Align the barrel on the FPL by moving the tripod legs.

---

---

**Performance Steps**

---



**Figure 071-000-0005-4. Traversing and elevating mechanism.**

- c. When assigned a PDF, lay the gun for direction.
  - (1) Align on the primary sector by traversing the slide to one side.
  - (2) Move the tripod to align the barrel on the sector limit.
  - (3) Align on the PDF by traversing the slide until the machine gun is aimed at the center of the target.
- d. Fix the tripod legs in place by digging them in or sandbagging them.
- e. Determine the direction to each target.
  - (1) Lay the gun on the base of the target.
  - (2) Read the direction on the traversing bar at the left edge of the traversing bar slide (figure 071-000-0005-4).
  - (3) Determine by the direction of the barrel whether the reading is right or left.
- f. Determine the elevation for each target.
  - (1) Lay the gun on the base of the target by rotating the elevating handwheel (figure 071-000-0005-4).
  - (2) Read the number (including a "+" or "-" sign, unless the number

---

**Performance Steps**

---

is "0") above the first visible line on the elevating scale. (In figure 071-000-0005-4, this reading is "-50.")

(3) Read, from the elevating handwheel, the number in line with the indicator. (In figure 071-000-0005-4, this reading is "3.")

6. Record the data you found using the T&E mechanism (figure 071-000-0005-4).

a. Enter the reading in the ELEVATION column in the DATA SECTION of the range card, separating the two numbers with a slash.

b. Enter the range to each target in the appropriate column in the DATA SECTION.

c. Enter the description of each target in the appropriate column in the DATA SECTION.

d. Fill in the REMARKS block for each target as needed.

e. Enter the width and depth (in mils) of linear targets. The "-4" in figure 071-000-0005-3, REMARKS block, means that depressing the barrel 4 mils will cause the strike of the rounds to go to ground level along the FPL.

f. When entering the target width (TW) in the REMARKS block, give the width in mils, and express it in two values. For example, in figure 071-000-0005-2, Target 3 measures 7 mils wide. The second value, R3, means that if the gunner lays the gun on the target and traverses 3 mils to the right, the point of aim will lay to the right edge of the target. Target 3, figure 071-000-0005-3, shows the width of the target as 15 mils; traversing 8 mils to the left will move the point of aim to the left edge of the target.

g. Do not determine data for the secondary sector of fire; the gunner will fire the weapon in the bipod mode.

7. Keep one copy of the range card at the machine gun position. Send the other copy to platoon headquarters. Complete range cards for primary positions. Partially prepare range cards for alternate and supplementary positions. Prepare the range card as soon as you arrive in a position, regardless of the expected length of stay. Continually revise the range card the whole time you occupy the position.

---

**Evaluation Preparation:**

*Setup:* Provide the soldier all the equipment needed to prepare a range card: pencil, paper, a stationary firing position, sector of fire, and target reference point designated.

*Brief Soldier:* Tell the soldier to prepare only one copy of the range card for training purposes.

<b>Performance Measures</b>	<b>GO</b>	<b>NO GO</b>
<b>1.</b> Prepared the range card.	—	—
<b>a.</b> Sketched the terrain located in front of the position.		
<b>b.</b> Determined the direction of magnetic north.		
<b>c.</b> Sketched in the direction of magnetic north.		
<b>d.</b> Completed the DATA SECTION.		
<b>e.</b> Determined the location of the gun position relative to a prominent terrain feature.		
<b>f.</b> Sketched in the primary sector of fire using either a PDF or a FPL.		
<b>g.</b> Labeled the targets.		
<b>h.</b> Sketched in the secondary sector of fire.		
<b>2.</b> Used the T&E mechanism, determined the direction, elevation, and range.	—	—
<b>a.</b> Centered the traversing handwheel.		
<b>b.</b> Laid the gun for direction.		
<b>c.</b> Adjusted the tripod legs.		
<b>d.</b> Read the direction to each target.		
<b>e.</b> Read the elevation to each target.		
<b>3.</b> Used the T&E mechanism to determine data for targets, then recorded it on the range card.	—	—
<b>a.</b> Entered the reading for elevation into the ELEVATION block in the DATA SECTION of the range card.		
<b>b.</b> Entered the range to the target into the RANGE block in the DATA SECTION of the range card.		
<b>c.</b> Described each target in writings.		
<b>d.</b> Completed the REMARKS block for each target, as needed.		

**Evaluation Guidance:** Score the soldier GO if all performance measures are passed. Score the soldier NO-GO if any performance measure is failed.

If the soldier scores NO-GO, show the soldier what was done wrong and how to do it correctly.

## References

### Required

FM 3-22.68

### Related

---

## 071-025-0001

### Maintain an M240B Machine Gun

**Conditions:** Given a cleared M240B machine gun; M122A1 tripod mount assembly; linked 7.62-mm ammunition; and a small-arms case with the following items: cleaner, lubricant, and preservative (CLP), lubricating oil arctic weather (LAW), rifle bore cleaner (RBC), rags, pipe cleaners, chamber and bore brushes, cleaning rod, cleaning rags, small-arms swabs, and an M240B scraper and reamer.

**Standards:** Cleaned and lubricated the M240B machine gun and components. Inspected all parts, components, and ammunition for serviceability; turned in unserviceable items to maintenance. Correctly assembled the gun and ensured it was operational.

---

### Performance Steps

1. Check to ensure the weapon is clear.

**WARNING**

Be sure to clear weapon before disassembling, cleaning, inspecting, transporting, or storing.

- a. Put safety to "F" (FIRE).
- b. Pull cocking handle assembly to the rear, locking the bolt to the rear. Return cocking handle to forward position.
- c. Place safety to "S" (SAFE).
- d. Push in latches to open cover assembly.
- e. Remove ammunition belt, if present.
- f. Raise feed tray.
- g. Inspect chamber area. Remove any ammunition, ammunition casings, or links.
  - (1) Check feed pawl assembly and feed tray assembly.
  - (2) Lift feed tray assembly and inspect the chamber.

---

**Performance Steps**

---

- (3) Check space between the face of the bolt and the chamber.
  - (4) Check space under the bolt and operating rod assembly.
  - h. Lower feed tray.
  - i. Place safety to "F."
  - j. Hold cocking handle assembly to rear, depress trigger, and ease bolt forward to close and lock.
  - k. Close cover assembly. Make sure it locks shut.
- Note.** Be sure bolt is forward with safety in "F" when gun is not in use.
2. Disassemble the M240B.

**WARNING**

A hot barrel can burn you. If the barrel is hot, use your heat resistant mittens.

**Note.** The following steps do not have to be performed in sequence.

- a. Remove barrel assembly.
    - (1) Check to ensure bolt is forward.
    - (2) Depress barrel locking latch and hold.
    - (3) Turn barrel carrying handle to upright position.
    - (4) Push forward and lift barrel out.
  - b. Remove heat shield assembly from barrel. Lift rear of heat shield assembly from barrel; pry front tabs out of holes on gas hole bushing.
  - c. Remove trigger-housing assembly.
    - (1) Depress spring pin and remove it (this can usually be done without tools).
    - (2) Pull trigger-housing assembly down and back, and remove it.
  - d. Remove butt stock and buffer assembly. Depress backplate latch and lift butt stock and buffer assembly straight up.
  - e. Remove driving spring rod assembly.
    - (1) Push driving spring rod assembly forward and up to disengage its retaining stud from the receiver.
    - (2) Pull rearward on driving spring rod and remove it from the receiver.
  - f. Remove bolt and operating rod assembly.
    - (1) Depress cover latches and raise cover assembly.
-

---

**Performance Steps**

---

(2) Pull cocking handle assembly back to move bolt and operating rod assembly to the rear of receiver.

(3) Reach into receiver and push rearward on bolt until bolt and operating rod assembly are slightly out of rear end of receiver.

(4) Grasp bolt and operating rod assembly and remove it from the receiver.

(5) Return cocking handle to forward position.

g. Remove cover assembly.

(1) Close cover.

(2) Push out spring pin as far as possible using backplate of the butt stock or buffer assembly. Then remove it with your fingers.

(3) Depress cover latches, lift up, and remove cover assembly.

(4) Remove feed tray.

h. Remove hand guard.

(1) Extend bipod legs to down and locked position.

(2) Pull hand guard straight down and off gas cylinder.

**WARNING**

Using gasoline, kerosene, hydraulic oil, benzene, benzol, high pressure water, steam, or air for cleaning is prohibited.

3. Clean the M240B parts, components, and ammunition.

**CAUTIONS**

1. Do not use abrasives to clean the bore, piston, gas cylinder, or gas regulator plug.
2. Do not submerge buffer in any liquid. Wipe with clean wiping rag only.
3. Avoid getting CLP in the gas cylinder when cleaning the bore.

a. Use cleaning patches, CLP, and bore brush to clean bore.

b. Use CLP on receiver brush bristles to clean the receiver.

c. Use rags and CLP to remove powder fouling, corrosion, dirt, and rust from all metal components and surfaces.

d. Use only a clean rag to clean the cover assembly.

e. Clean the gas cylinder.

(1) Use a gas cylinder cleaning brush dampened with CLP to clean gas cylinder bore.

(2) Use a combination tool to clean front interior of gas cylinder.

---



---

**Performance Steps**

---

(a) Insert the combination tool with handle upward into the front end of the gas cylinder of the receiver body. Ensure the tool is fully inserted and seated against the gas cylinder.

(b) Apply slight pressure to the handles and turn clockwise to remove carbon.

f. Clean gas regulator using the scraper and reamer.

(1) Insert the scraper into the central hole of the gas regulator plug. Remove carbon by twisting the scraper clockwise until it is fully seated against gas regulator plug.

(2) Clean regulator plug grooves by inserting the scraper tool into the grooves and turning regulator plug clockwise.

(3) Insert the small reamer into each gas inlet hole and twist back and forth to remove carbon (use hand pressure only).

(4) Scrape carbon from surface of gas regulator plug using tip of scraper.

(5) Insert large reamer through hole in gas port bushing into gas port hole in barrel; remove carbon by twisting reamer back and forth until it enters bore of barrel.

g. Clean M122A1 tripod assembly.

(1) T&E mechanism. Use a clean dry wiping rag to remove foreign matter. Use small arms cleaning brush to clean numbers on the scale.

(2) Tripod assembly and flex mount. Use a cleaning rag saturated with carbon-removing compound to clean them with clean wiping rags to wipe all parts dry.

h. Clean Ammunition. Use a clean dry wiping rag to remove foreign matter.

4. Inspect the M240B parts, components, and ammunition.

a. Barrel assembly.

(1) Check barrel for bulges, bends, burrs, or pits in the chamber or bore.

(2) Check to ensure flash suppressor is not loose.

(3) Check front sight for damage and looseness.

(4) Check barrel carrying handle assembly for damaged or missing parts. Move the barrel release slowly to the right and count the clicks. Fewer than two, or more than seven clicks indicate defective parts.

(5) Check to ensure heat shield is present, securely attached to barrel, and undamaged.

---

---

**Performance Steps**

---

**b. Butt stock and buffer assembly.**

- (1) Check for burrs and rough edges on the mating grooves and flanges.
- (2) Check the backplate latch to ensure it locks the buffer assembly securely.
- (3) Check the buffer plug and ensure it sticks out through the backplate and is flush or higher than the protrusion below it.
- (4) Check the buffer for rattling sounds by shaking; ensure that the plug cannot rotate by finger pressure.
- (5) Check the butt stock for cracks.

**c. Driving spring rod assembly.**

- (1) Check the spring for broken strands.
- (2) Check the rod assembly for bends.

**d. Bolt and operating rod assembly.**

- (1) Inspect the bolt and operating rod assembly for bent, broken, cracked or missing parts. Check for burrs or pits on the surface.
- (2) Check for cracks or wear on the tip of the firing pin.
- (3) Ensure you cannot move extractor with your fingers.

**e. Trigger-housing assembly**

- (1) Check for broken, missing, or damaged parts.
- (2) Inspect the tripping lever and sear for burrs on edges.
- (3) Check cocking action by pushing back on the tripping lever (sear will rise). Pull the trigger (sear will lower).
- (4) Check safety. Place on "S" (SAFE) and pull the trigger. The sear should not drop down far enough to lock in the downward position. Place the safety on "F" (FIRE) and pull the trigger. The sear should drop down and lock in the downward position.

**f. Cover assembly.**

- (1) Pivot the feed lever back and forth to ensure it operates smoothly without binding.
  - (2) Push in on the cover latches to make sure the retaining clip is present, secure, and does not bind in the housing.
  - (3) Push down on the cartridge guides and feed pawls to make sure the springs are present and secure.
  - (4) Inspect accessory-mounting rail for nicks or burrs.
-

---

**Performance Steps**

---

**g.** Feed tray. Check for cracks, deformation, broken welds, and loose rivets.

**h.** Hand guard. Check for cracks and broken or missing parts.

**i.** Receiver assembly.

**(1)** Check that the rear sight is securely mounted and operates properly.

**(2)** Check that the cocking handle operates properly.

**(3)** Check for damaged or missing ejection port cover, spring, and pin. Check for proper operation of ejection port cover.

**(4)** Lower and raise the bipod legs to ensure they move freely without binding.

**(5)** Check accessory-mounting rail for nicks or burrs that may prevent proper attachment of optional sighting devices.

**(6)** Check barrel locking latch and cover detent for proper spring tension.

**j.** Components.

**(1)** T&E mechanism.

**(a)** Inspect hand wheels for smooth operation or rust.

**(b)** Check threads for burrs and rust.

**(c)** Check traversing slide lock for spring action. Ensure elevating mechanism sleeve fits on traversing bar and clamps firmly.

**(d)** Check traversing and elevating scales for legibility.

**(e)** Inspect quick release pin and chain for burrs and rust. Check for missing spring-loaded balls.

**(2)** Tripod assembly.

**(a)** Check for completeness of tripod. Ensure that all nuts and bolts are tightly secured.

**(b)** Inspect for cracks on the legs and tripod head.

**(c)** Check for missing, broken, or inoperative lock latch.

**(d)** Check pintle lock release cam for correct operation.

**(e)** Check locking action of front leg clamping assembly.

**(f)** Check that the rear legs lock in the open position. Ensure sleeve latch notch and right leg slide notch engages completely. Ensure latch spring has good tension.

**(g)** Check telescoping, indexing, and locking action of rear legs and front leg locking assemblies.

---

---

**Performance Steps**

---

**(3)** Flexible mount assembly.

**(a)** Check for missing or damaged parts. Check for rust, cracks, and burrs.

**(b)** Inspect pintle lock assembly for nut, bolt, and cotter pin. Check pintle surface for burrs and rust.

**k.** Inspect or check ammunition for damage and corrosion. Turn in any unserviceable ammunition.

**5.** Lubricate M240B parts and components.

**a.** Generously lube the following parts:

**(1)** Barrel assembly—on the camming surfaces of the bolt-locking lugs.

**(2)** Operating rod—on the rollers, camming recess, and those surfaces immediately below the yoke that ride within the receiver rails.

**(3)** Cover—in the feed cam assembly.

**(4)** Bolt—on the bolt-locking lugs and actuator cam roller.

**b.** Lightly lube the following parts:

**(1)** Driving spring.

**(2)** Bolt and operating rod assembly moving parts, polished areas, firing pin, and roller.

**c.** Do not lubricate the following parts:

**(1)** Butt stock.

**(2)** Face of bolt.

**(3)** Piston.

**(4)** Gas regulator and gas cylinder.

**(5)** Rear sight.

**(6)** Composite or rubber components.

**d.** Lightly lubricate all components and wipe with oily rag to remove excess oil.

**6.** Assemble the M240B.

**a.** Replace barrel assembly.

**(1)** Insert gas regulator plug into the gas hole bushing with the number 1 gas setting facing the barrel.

**(2)** Place gas collar over the front end of the gas regulator plug. Rotate collar until it slips onto gas regulator plug. Press in and rotate counterclockwise to lock in place (pull collar to be sure it is in the locked position).

---

---

**Performance Steps**

---

(3) Install heat shield on barrel. Insert the front metal tabs of the heat shield into the holes located on the sides of the gas hole bushing. Push down on the heat shield so it snaps onto the barrel.

(4) With gas regulator downward and the carrying handle in the vertical position, insert barrel fully into the receiver socket and push barrel carrying handle to the right as far as it will go to lock (fewer than two or more than seven clicks indicate defective parts). Do not force. If barrel binds in socket or if barrel carrying handle will not rotate when pushed, do not pound on barrel carrying handle. Take machine gun to unit maintenance.

b. Replace cover assembly and feed tray.

(1) Align the feed tray guides with receiver brackets.

(2) Place cover assembly onto the receiver with its mounting holes aligned with mounting brackets on the receiver.

(3) Close cover assembly. To secure the cover and feed tray to the receiver; insert the spring pin in the mounting holes from the right side only. Open cover assembly. Check to ensure cover detent holds cover assembly open. If cover assembly does not remain open in two positions, notify unit maintenance.

c. Replace trigger-housing assembly.

(1) Insert the holding notch on the trigger-housing into the forward recess on the bottom of the receiver.

(2) Lift the trigger-housing up and align holes of trigger-housing with the mounting holes of the receiver.

(3) Hold the trigger-housing in place and insert the spring pin.

d. Replace bolt and operating rod assembly.

(1) Insert the bolt and operating rod assembly into the rear of the receiver. Ensure bolt is on top of receiver rails.

(2) Push the assembly into the receiver as far as possible. Pull the trigger and hold it while pushing the assembly all the way into the receiver.

(3) Close cover assembly.

e. Replace the driving spring rod assembly.

(1) Insert driving rod spring assembly all the way into the receiver.

(2) Push in and lower driving rod spring assembly to seat the retaining stud in the hole on the bottom of the receiver.

f. Replace butt stock and buffer assembly.

(1) Position the bottom recess grooves of the butt stock onto the top of the receiver recess grooves.

---

---

**Performance Steps**

---

(2) Slide the butt stock down until it locks on the receiver. Top of buffer should be flush with top of receiver.

7. Perform a function check to ensure the M240B is assembled correctly.

---

**Evaluation Preparation:**

*Setup:* At the test site, provide all the equipment and materials listed in task conditions. Use only dummy ammunition for training purposes.

*Brief Soldier:* Tell soldier to perform maintenance on the M240B and linked 7.62-mm ammunition.

Performance Measures	GO	NO GO
1. Checked to ensure the weapon was clear.	___	___
2. Disassembled the M240B.	___	___
3. Cleaned the M240B parts, components, and ammunition.	___	___
4. Inspected the M240B parts, components, and ammunition.	___	___
5. Lubricated M240B parts and components.	___	___

**Evaluation Guidance:** Score the soldier GO if all performance measures are passed. Score the soldier NO GO if any performance measure is failed. If the soldier scores NO GO, show him what was done wrong and how to do it correctly.

**References****Required****Related**

FM 3-22.68

TM 9-1005-313-10

---

**071-025-0003****Load an M240B Machine Gun**

**Conditions:** Given a cleared M240B machine gun (mounted on bipod, tripod, or vehicle) and linked 7.62-mm ammunition.

**Standards:** Loaded linked ammunition in the feed tray groove so that, when the cover was closed, a round remained in the tray groove and ammunition fed correctly.

3-334

071-025-0003

---

**Performance Steps**

---

1. Clear the weapon.
  - a. Place safety to the "F" position.
  - b. Charge the weapon.
    - (1) Pull the cocking handle to the rear, locking the bolt in the rear position.
    - (2) Push the cocking handle to the forward and locked position.
  - c. Place safety to the "S" position.
  - d. Open the cover assembly.
    - (1) Press in and hold the feed cover latches.
    - (2) While holding the latches, lift up on the cover assembly.
  - e. Remove any ammunition that is present.
  - f. Raise the feed tray.
  - g. Inspect the chamber to ensure no ammunition is present.
  - h. Lower the feed tray.
  - i. Place safety to the "F" position.
  - j. Pull and hold cocking handle to the rear.
  - k. While holding the cocking handle to the rear, depress the trigger and ease the bolt forward to the closed and locked position.
2. Load ammunition.

**Note.** Position the open side of links in the down position.

- a. Place link belt on feed tray with the first round against the cartridge stop and tip of round pointing toward the barrel.
- b. Close the cover assembly ensuring the latches lock into place.

**CAUTION**

Make sure round does not move away from cartridge stop during closing and latching of cover.

---

**Evaluation Preparation:**

**Setup:** Use dummy ammunition to test this task. At the test position, provide an M240B and a belt of linked dummy 7.62-mm ammunition. For standardization, always place the bolt and cocking handle forward and the safety on "S." Ensure the ammunition is clean and linked properly.

**Brief Soldier:** Tell the soldier to load the M240B machine gun.

Performance Measures	GO	NO GO
1. Cleared weapon.	___	___
2. Loaded ammunition.	___	___

**Evaluation Guidance:** Score the soldier GO if all performance measures are passed. Score the soldier NO GO if any performance measure is failed. If the soldier scores NO GO, show what was done wrong and how to do it correctly.

#### References

##### Required

##### Related

FM 3-22.68

TM 9-1005-313-10

---

## 071-025-0004

### Unload an M240B Machine Gun

**Conditions:** Given an M240B loaded with linked 7.62-mm ammunition.

**Standards:** Removed all ammunition and links from the weapon. Cleared the weapon, ensured the chamber was empty and the safety was on "F" (FIRE).

---

#### Performance Steps

1. Remove ammunition from the M240B.
    - a. With palm up, pull the cocking handle to the rear, ensuring that the bolt locks to the rear.
    - b. Return the cocking handle to its forward position.
    - c. Place the safety lever on "S" (SAFE).
    - d. Raise the cover and remove ammunition belt.
    - e. Remove any ammunition, links, or brass from the chamber area.
  2. Clear the M240B.
    - a. Confirm that no ammunition remains in the chamber.
    - b. Close the cover.
    - c. Place the safety on "F" (FIRE).
    - d. With palm up, pull the cocking handle to the rear and hold it.
-



---

**Performance Steps**

---

**CAUTION**

The bolt must be eased forward to prevent damage to the feed tray assembly and operating rod assembly.

- e. Pull the trigger, allowing the bolt to ease forward.
  - f. Place the safety on "F" (FIRE).
- 

**Evaluation Preparation:**

*Setup:* At the test site, provide the soldier with all the equipment listed in the task conditions. Use only dummy ammunition for training purposes.

*Brief Soldier:* Tell soldier he must unload the M240B.

Performance Measures	GO	NO GO
1. Removed ammunition from the M240B.	___	___
2. Cleared the M240B.	___	___

**Evaluation Guidance:** Score the soldier GO if all performance measures are passed. Score the soldier NO GO if any performance measure is failed. If the soldier scores NO GO, show him what was done wrong and how to do it correctly.

**References****Required****Related**

FM 3-22.68

TM 9-1005-313-10

---

**071-025-0007****Engage Targets with an M240B Machine Gun**

**Conditions:** Given an M240B machine gun, linked 7.62-mm ammunition, engageable targets in your assigned sector of fire, and a requirement to engage those targets.

**Standards:** Fired the M240B machine gun to engage targets in the assigned sector of fire. Used correct M240B machine gun target engagement techniques so you hit each target.

---

**Performance Steps**

---

1. Assume a suitable firing position. Based on the situation, assume the position that allows you to observe and engage targets yet minimize your exposure to enemy fire.
  - a. Tripod firing. A number of firing positions can be used based on situation (prone, sitting, or kneeling; or standing if firing from prepared position).
  - b. Bipod firing. Prone supported position and bipod-supported fighting position are the best for delivering effective fire on targets. Assume these positions when possible.
    - (1) Shoulder firing position. Use this position to engage specific targets during movement when you can assume no other position or the situation dictates its use, such as the final stages of an assault.
    - (2) Underarm firing position. Use this position when closing with the enemy, when a heavy volume of fire in the target area is required, and when rapid movement is necessary.
    - (3) Hip firing position. Use this position when a heavy volume of fire in the target area is required and rapid movement is not necessary.
2. Identify targets in your designated sector of fire.
3. Align the sights on the target.
  - a. Obtain sight alignment by centering the front sight blade in the aperture of the rear sight with the top of the front sight blade even with the top of the rear sight slide.
  - b. Obtain a sight picture by centering the target over the front sight blade so it appears to rest on top of the front sight blade and on top of the rear sight slide.
4. Load and engage targets using correct M240B firing techniques.
  - a. Use correct trigger manipulation.
    - (1) Pull straight to the rear and release.
    - (2) Fire the weapon at the rate of fire appropriate for the target (sustained, rapid, or cyclic).
  - b. Use correct fire engagement technique based on target type.
    - (1) Deliver fixed fire against a point target when only one aiming point is necessary to cover the target with fire.
    - (2) Use traversing fire to distribute fire on wide targets by successive changes in direction.
      - (a) With the tripod-mounted gun, make changes in 2- to 6-mil increments on the traversing hand wheel between bursts.

---

**Performance Steps**

---

(b) With the bipod-mounted gun, make minor changes by shifting your shoulders to the right or left to select successive aiming points throughout the width of the target area. For major changes, move your elbows and align your body to remain directly behind the gun.

(3) Use searching fire to distribute fire on deep targets by successive changes in elevation.

(a) With the tripod-mounted gun, make changes in 2-mil increments on the elevating hand wheel between bursts.

(b) When using the bipod, move elbows closer together to lower the muzzle, or farther apart to raise the muzzle.

(4) Use traversing and searching fire to distribute fire on wide and deep targets by successive changes in direction and elevation. Make adjustments in the same manner as described for traversing and searching fire.

(5) Use swinging traverse fire (tripod-mounted gun only) to deliver fire against targets too wide to cover with the traversing hand wheel or against fast moving targets. Loosen the traversing slide lock lever and make changes in direction by moving the muzzle left or right. Make changes in elevation by turning the elevating hand wheel.

(6) Use free gun fire (tripod- or vehicle-mounted gun only) against targets requiring rapid major changes in direction and elevation. To deliver this type of fire, remove the T&E mechanism from the receiver to allow the gun to be moved in any direction.

c. Use correct application of fire to engage specific types of targets (for single gun engagement).

(1) Point target. Engage point targets with fixed fire.

(2) Area target. Initially aim at the midpoint of the target area. Traverse and search to either flank, then back to the opposite flank.

(3) Linear target. Initially aim at the midpoint of the target. Traverse fire to one flank then to the other to cover the entire target.

(4) Deep target. Initially aim at the midpoint of the target unless another portion of the target is more critical or presents a greater threat. Search down to one aiming point in front of the near end and back up to one aiming point beyond the far end.

(5) Linear target with depth. Initially aim at the midpoint of the target unless another portion of the target is more critical or presents a greater threat. Traverse and search to the flank closest to your position, then back to the other to cover the entire target.

---

---

**Performance Steps**

---

(6) Moving target. To hit a moving target, estimate the speed of the target and the lead required to fire and hit it. Fire and track the target as it moves. Adjust the lead by observing tracers and the strike of the bullets.

d. Adjust fire to place effective fire on the target. Based on time, range, and amount of adjustment, use one of the following methods:

(1) Sight correction method. When the initial burst is not correctly placed, adjust elevation and windage as required. This method is time-consuming.

(2) Adjusted aiming point method. Use the adjusted aiming point method to adjust fires quickly without making a sight adjustment. If the initial burst misses the target, rapidly select a new aiming point the same distance from the target as the center of impact of the initial burst but in the opposite direction.

---

**Evaluation Preparation:**

*Setup:* Evaluate this task on a live-fire range. Evaluate the soldier's ability to use correct engagement techniques to engage specific types of targets. Provide the soldier with equipment and materials required to fire the course.

*Brief Soldier:* Brief soldier on range safety per installation regulations. Tell the soldier to assume the bipod-supported prone position or bipod-supported fighting position. Tell him you are evaluating both his ability to adjust fire and his ability to hit the target.

Performance Measures	GO	NO GO
1. Assumed a suitable firing position.	___	___
2. Identified targets in designated sector of fire.	___	___
3. Aligned the sights on the target.	___	___
4. Loaded and engaged targets using correct M240B firing techniques.	___	___

**Evaluation Guidance:** Score the soldier GO if all performance measures are passed. Score the soldier NO GO if any performance measure is failed. If the soldier scores NO GO, show him what was done wrong and how to do it correctly.

**References****Required****Related**

FM 3-22.68

TM 9-1005-313-10

**SUBJECT AREA 11: M249 MACHINE GUN**

**071-010-0006**

**Engage Targets with an M249 Machine Gun**

**Conditions:** Given an M249 machine gun and linked 5.56-mm ammunition.

**Standards:** Applied correct M249 machine gun target engagement techniques and hit each target in your assigned sector of fire.

**Performance Steps**

1. Assume a suitable firing position. Based on the situation, assume the position that will allow you to observe and engage targets, yet minimize your exposure to enemy fire.

a. Bipod-supported prone. The bipod-supported prone position (figure 071-010-0006-1) and the bipod-supported fighting position (figure 071-010-0006-2) are the best positions for delivering effective fire on targets. Assume these positions when possible.

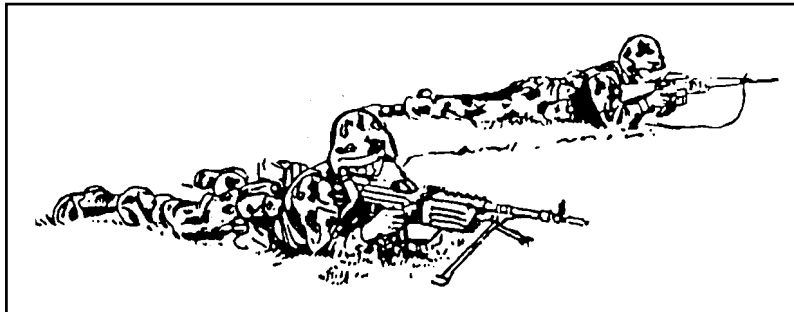
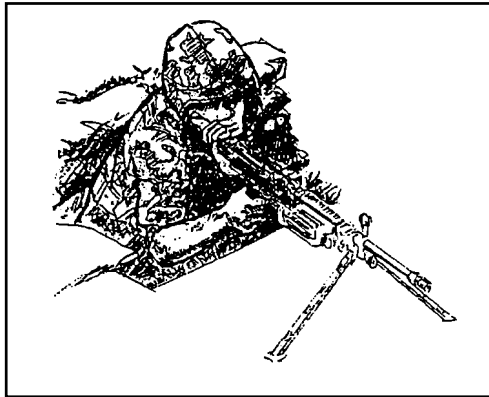


Figure 071-010-0006-1. Bipod-supported prone position

---

**Performance Steps**

---



**Figure 071-010-0006-2. Bipod-supported fighting position**

**b. Shoulder.** Use the shoulder firing position (figure 071-010-0006-3) to engage targets at ranges less than 100 meters when no other position can be assumed or when the situation dictates its use, for example in the final stages of the assault.



**Figure 071-010-0006-3. Shoulder firing position**

---

---

**Performance Steps**

---

c. Underarm. Use the underarm firing position when moving in and around the objective during the assault (figure 071-010-0006-4).



**Figure 071-010-0006-4. Underarm firing position**

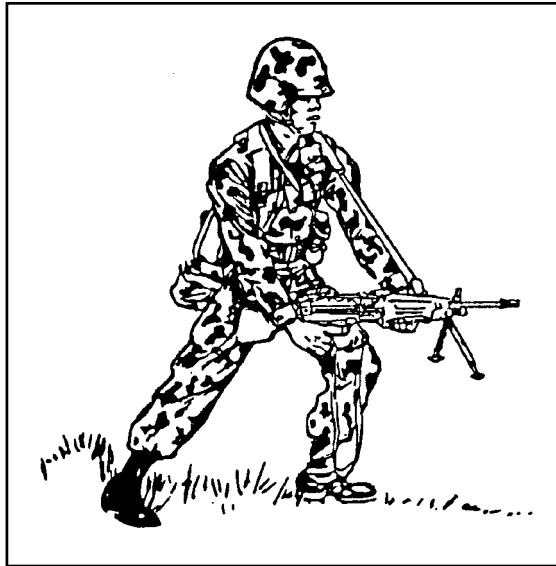
d. Hip. Use the hip firing position when closing with the enemy, when a heavy volume of fire in the target area is required, and when rapid movement is not necessary (figure 071-010-0006-5).

---

---

**Performance Steps**

---



**Figure 071-010-0006-5. Hip firing position**

2. Fire the weapon using the correct sight picture (figure 071-010-0006-6).
    - a. Sight alignment. Center the front sight post in the peep sight (A, figure 071-010-0006-6).
    - b. Focus of the eye. Place the eye directly on line with the center of the rear sight. Focus on the tip of the front sight post. The natural ability of the eye to center objects in a circle and to seek the point of greatest light (center of the peep sight) aids in providing correct sight alignment.
    - c. Sight picture. Center the target over the front sight post (B, figure 071-010-0006-6). If firing on a 10-meter range target, use the sight picture in C, figure 071-010-0006-6.
-



---

**Performance Steps**

---

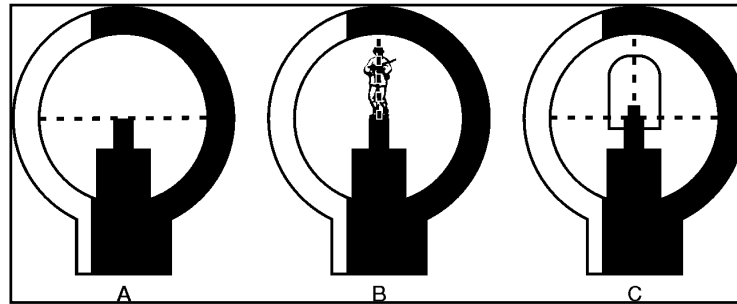


Figure 071-010-0006-6. Sight picture

3. Fire the weapon in three-round bursts at the rate of fire appropriate for target size. Use correct trigger manipulation: Pull straight to the rear and release.
4. Apply correct engagement technique based on target types (figure 071-010-0006-7).

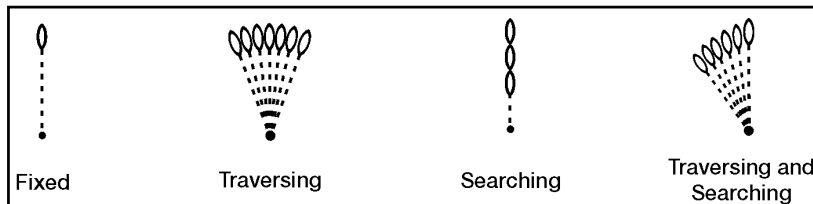


Figure 071-010-0006-7. Classes of fire with respect to the weapon

- a. Fixed fire. This type of fire is delivered against a point target when the depth and width of the beaten zone will cover the target. Only one aiming point is necessary to cover the target with fire.
  - b. Traversing fire. This type of fire is distributed in width by successive changes in direction. This means moving the muzzle of the weapon to the left or right to distribute fire laterally. To make minor changes in direction, shift the shoulders to the right or left to select successive aiming points throughout the width of the target area. For major changes, move the elbows and align the body to remain directly behind the gun.
-

---

**Performance Steps**

---

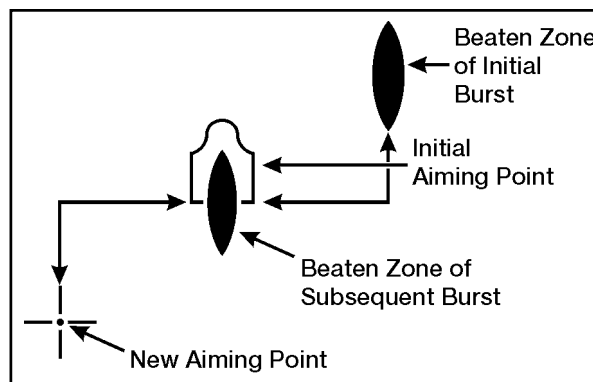
**c.** Searching fire. This type of fire is distributed in depth by successive changes in elevation. This means moving the muzzle of the weapon up or down to distribute fire in depth. Select successive aiming points in depth throughout the target area. To make changes in elevation, move elbows closer together to lower the muzzle or farther apart to raise the muzzle.

**d.** Traversing and searching fire. This type of fire is distributed in width and depth by successive changes in direction and elevation. Combining traversing and searching fire provides good coverage of the target. Adjustments are made in the same manner as described for traversing and searching fire. This means moving the muzzle of the weapon to the left or right to distribute fire laterally. To make minor changes in direction, shift the shoulders to the right or left to select successive aiming points throughout the width of the target area. For major changes, move the elbows and align the body to remain directly behind the gun.

**5.** Use observation of fire and adjustment of fire to place effective fire on the target.

**a.** Observation of fire. Observe the burst of fire by noting the strike of the rounds in the target area, the tracers in flight or, in the case of the 10-meter range, the holes made in the target.

**b.** Adjustment of fire. Use the adjusted aiming point method to quickly adjust fires without making a sight adjustment. If the initial burst misses the target, rapidly select a new aiming point the same distance from the center of impact of the initial burst but in the opposite direction. Fire a second burst (figure 071-010-0006-8).



**Figure 071-010-0006-8. Adjusted aiming point method**

---

---

**Performance Steps**

---

6. Use correct application of fire to engage specific targets.

a. Point target. Engage point targets with fixed fire (figure 071-010-0006-9).

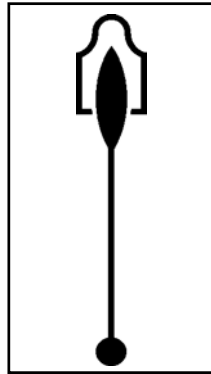


Figure 071-010-0006-9. Engagement of point target

b. Area target. Initially, aim at the midpoint of the target area. Traverse and search to either flank, then back to the opposite flank (figure 071-010-0006-10).

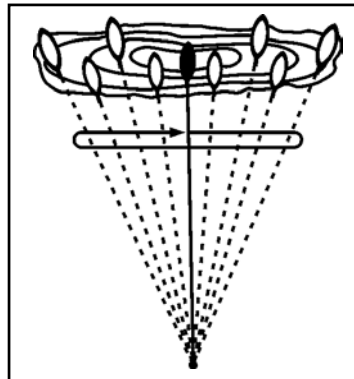


Figure 071-010-0006-10. Engagement of area target

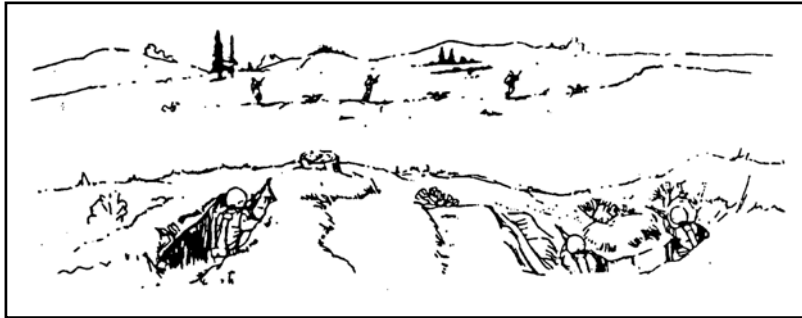
---

---

**Performance Steps**

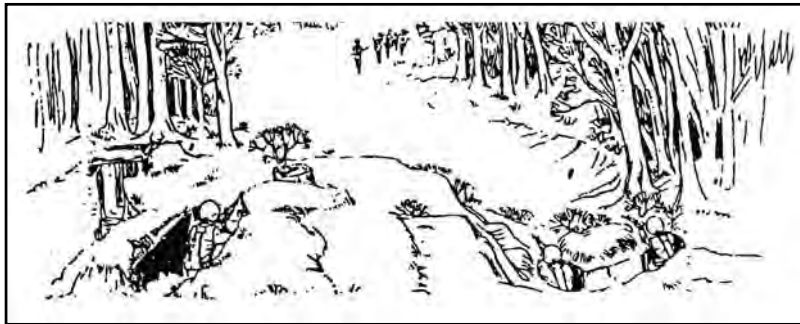
---

c. Linear target. Initially, aim at the midpoint of the target. Traverse fire to one flank and then to the other to cover the entire target (figure 071-010-0006-11).



**Figure 071-010-0006-11. Linear target**

d. Deep target. Initially, aim at the midpoint of the target unless another portion of the target is more critical or presents a greater threat. Search down to one aiming point in front of the near end and back up to one aiming point beyond the far end (figure 071-010-0006-12).



**Figure 071-010-0006-12. Deep target**

e. Linear target with depth. Initially, aim at the midpoint of the target unless another portion of the target is more critical or presents a greater threat. Traverse and search to the flank closest to your position then back to the other flank to cover the entire target (figure 071-010-0006-13).

---

---

**Performance Steps**

---



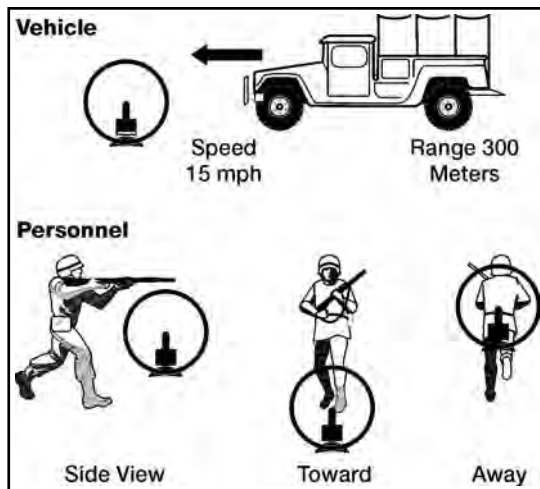
**Figure 071-010-0006-13. Linear targets with depth**

f. Moving target. To hit a moving target, estimate the speed of the target and the lead required to fire and hit it, fire and track the target as it moves, and adjust the lead by observing tracers and the strike of the bullets (table 071-010-0006-1 and figure 071-010-0006-14).

---

**Performance Steps**

Table 071-010-0006-1. Vehicle lead			
Speed in Miles per Hour	Range of Target		
	300 M	500 M	900 M
15	½ target length	1 target length	2 target lengths



**Figure 071-010-0006-14. Moving target aiming points.**

**Evaluation Preparation:**

*Setup:* Evaluate this task on a live-fire range by having the soldier fire Table IV in FM 3-22.68. Evaluate the soldier's ability to use correct engagement techniques to engage specific types of targets. Provide the soldier with equipment and materials required to fire the course.

*Brief Soldier:* Brief soldier on range safety per installation regulations. Tell the soldier to assume the bipod-supported prone position or bipod-supported fighting position. Tell the soldier you are evaluating both his ability to adjust fire and his ability to hit the target.

Performance Measures	GO	NO GO
1. Assumed correct bipod-supported prone position or bipod-supported fighting position.	___	___
2. Fielded zero on a 300-meter target with no more than 12 rounds.	___	___

Performance Measures	GO	NO GO
3. Engaged single E-type silhouettes (point targets) at various ranges.	—	—
4. Engaged double E-type silhouettes (automatic weapon positions) at various ranges.	—	—
5. Engaged linear E-type silhouettes (troops on line) at various ranges.	—	—

**Evaluation Guidance:** Score the soldier GO if all performance measures are passed. Score the soldier NO GO if any performance measure is failed. If the soldier scores NO GO, show him what was done wrong and how to do it correctly

#### References

**Required**

**Related**

FM 3-22.68

---

## 071-312-4025

### Maintain an M249 Machine Gun

**Conditions:** Given an M249 machine gun; linked 5.56-mm ammunition; cleaning kit with pipe cleaners, small-arms swabs, chamber and bore brushes, cleaning rod, wiping rags, scraper tool, and cleaner lubricant preservative (CLP). You have a requirement to maintain the weapon.

**Standards:** Cleaned and lubricated the M249 machine gun; inspected parts; and turned in unserviceable parts. Assembled the gun and ensured it was operational. Cleaned and inspected linked 5.56-mm ammunition for serviceability. Turned in unserviceable ammunition.

---

#### Performance Steps

**Note.** The M249 is available with old and new style barrels. Diagrams used here show the new-style barrel.

1. Clear the M249 machine gun.
    - a. Move the safety to the fire position.
    - b. With your right hand, palm up, pull the cocking handle to the rear and lock the bolt to the rear.
    - c. Hold the cocking handle to the rear and move the safety to the safe position. Push the cocking handle forward to the locked position. Place weapon on safe.
-

---

**Performance Steps**

---

- d. Push the cocking handle forward to its locked position (you should hear a click).
  - e. Raise the cover and feed mechanism assembly. To check for brass, links, or ammunition—
    - (1) Check the feed pawl assembly under the feed cover.
    - (2) Check the feed tray assembly.
    - (3) Lift the feed tray assembly and inspect the chamber.
    - (4) Check the space between the bolt assembly and chamber.
    - (5) Insert two fingers in the magazine well and feel for brass or ammunition.
  - f. Close the cover and feed mechanism assembly. Move the safety to the fire position.
  - g. Pull the cocking handle to the rear, press the trigger, and ease the bolt forward.
2. Disassemble the M249 machine gun.

**WARNING**

Ensure bolt is in forward position before removing drive spring, return rod, and transfer mechanism assembly.

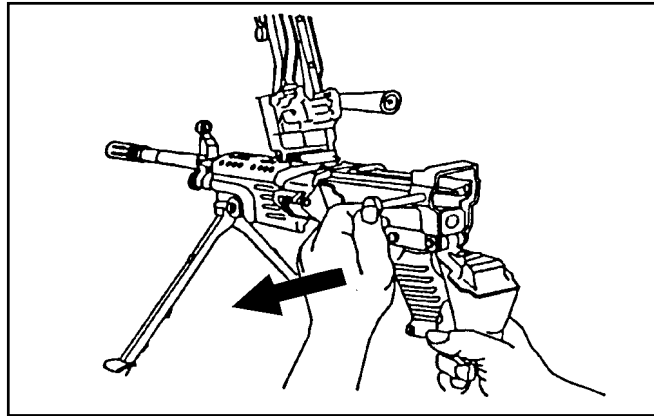
- a. Remove the drive spring, return rod, and transfer mechanism assembly.
    - (1) Raise the cover assembly. Pull the upper retaining pin at the rear of the receiver to the left. Let the butt pivot downward so the rear opening of the receiver is clear (figure 071-312-4025-1).
-



---

**Performance Steps**

---



**Figure 071-312-4025-1. Rear opening of the receiver**

**Note.** The upper and lower retaining pins in the rear of the receiver are captured pins. Do not try to remove them completely during disassembly.

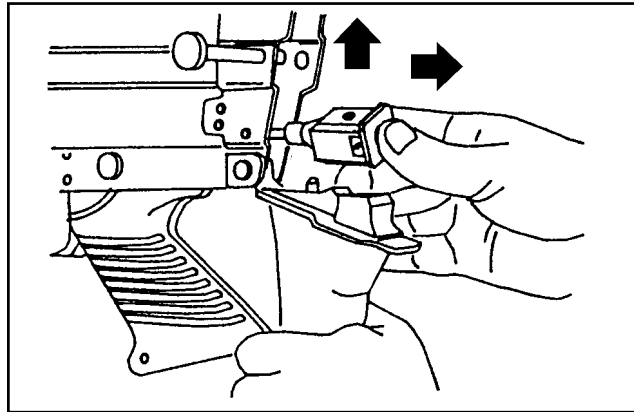
**(2)** Hold the weapon with one hand on the buttstock. At the same time, push in and upward on the rear end of return rod and transfer mechanism assembly with thumb of other hand to release it from positioning groove. Withdraw return rod and transfer mechanism assembly and spring (figure 071-312-4025-2).

---

---

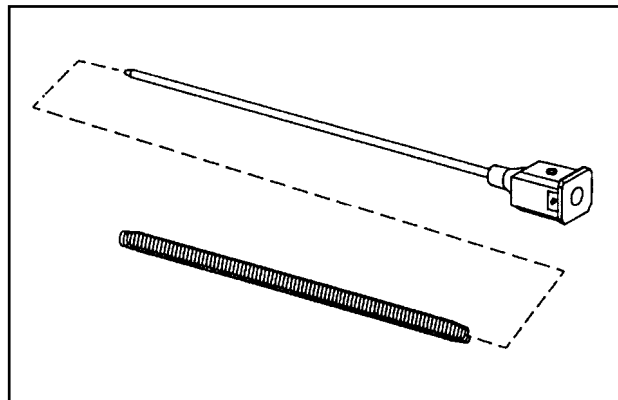
**Performance Steps**

---



**Figure 071-312-4025-2. Removal of the return rod and transfer mechanism assembly**

**(3)** Separate the spring from the return rod and transfer mechanism assembly (figure 071-312-4025-3).



**Figure 071-312-4025-3. Removal of the spring**

**b.** Remove the operating rod, slide assembly, and bolt assembly.

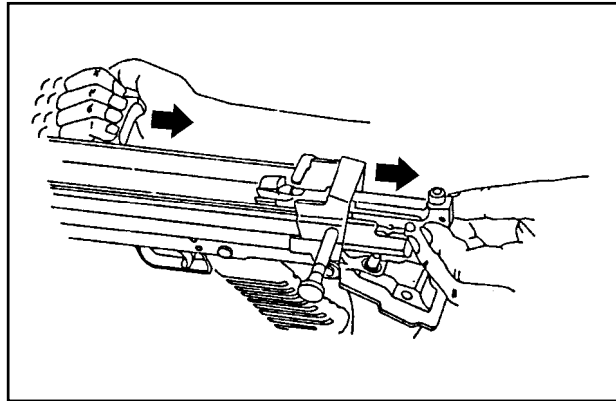
**(1)** Pull the cocking handle to the rear to move operating rod, slide assembly, and bolt assembly out the rear of the receiver (figure 071-312-4025-4).

---

---

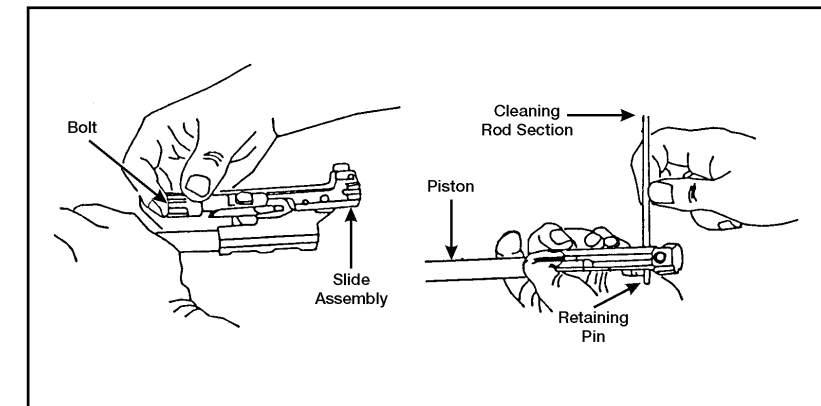
**Performance Steps**

---



**Figure 071-312-4025-4. Removal of the operating rod, slide assembly, and bolt assembly**

(2) Rotate the bolt clockwise to disengage the lug. Remove the bolt from the slide assembly. Separate the piston from the slide assembly by pressing the rearmost retaining pin to the left and lifting the piston off the slide assembly (figure 071-312-4025-5).



**Figure 071-312-4025-5. Removal of the bolt and piston**

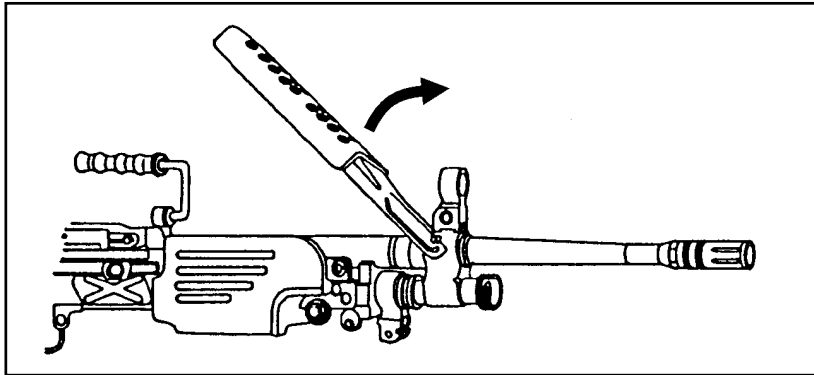
c. Remove the heat shield. Hold the weapon with one hand. With the other hand, grasp the heat shield just forward of the barrel handle, and lift it off the barrel (figure 071-312-4025-6).

---

---

**Performance Steps**

---

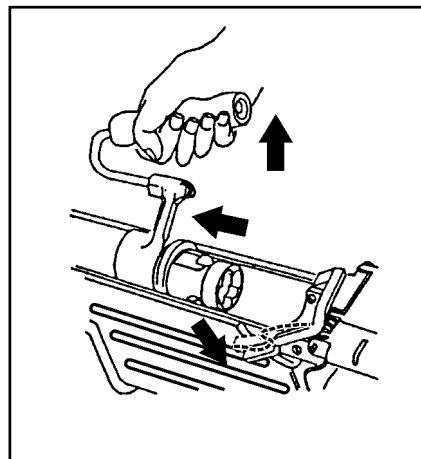


**Figure 071-312-4025-6. Removal of the heat shield**

**d.** Remove the barrel (figure 071-312-4025-7).

**(1)** Ensure the folding handle on the new style barrel is in carrying (up) position.

**(2)** Depress the barrel locking lever with your left hand. Grasp and lift the carrying handle with your right hand. Push the barrel forward.



**Figure 071-312-4025-7. Remove the barrel**

**e.** Remove the handguard (figure 071-312-4025-8)

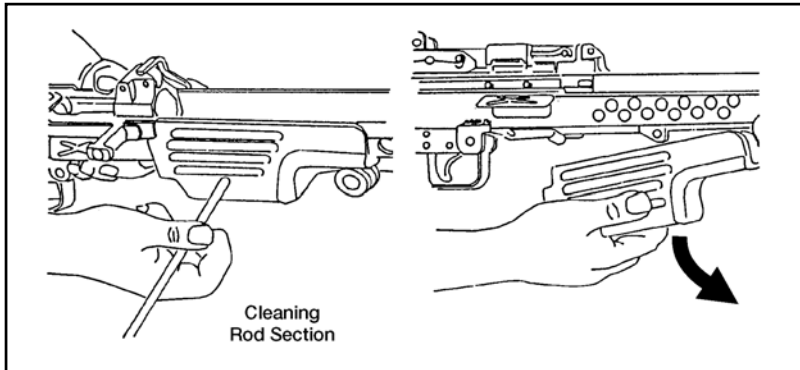
---

---

**Performance Steps**

---

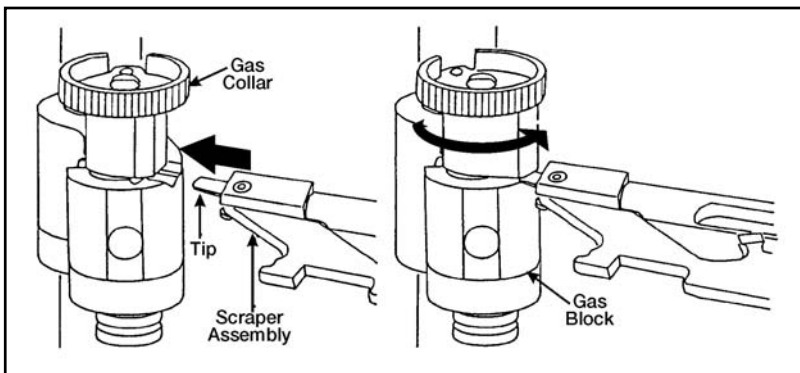
- (1) Push the handguard retaining pin to the left using a section of the cleaning rod.
- (2) Pull downward and remove the handguard.



**Figure 071-312-4025-8. Remove the handguard**

**f. Remove the gas regulator.**

- (1) Position the gas collar so you can insert the scraper assembly into the notch in the front left of the gas block.
- (2) Insert the tip of the scraper assembly in the notch; hold the scraper firmly in position (figure 071-312-4025-9).



**Figure 071-312-4025-9. Insertion of the scraper assembly**

---

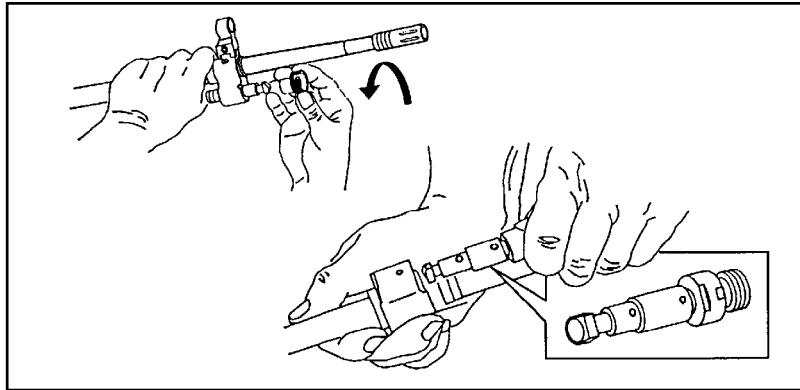
---

**Performance Steps**

---

(3) Turn the collar counterclockwise and remove it (figure 071-312-4025-10).

(4) Remove the gas regulator from the gas block (figure 071-312-4025-10).



**Figure 071-312-4025-10. Removal of the gas regulator from the gas block**

**g.** Remove the buttstock and buffer assembly.

**Note.** The upper and lower retaining pins in the rear of the receiver are captured pins. Do not try to remove them completely during disassembly.

(1) Using a section of the cleaning rod, push the lowermost retaining pin to the left.

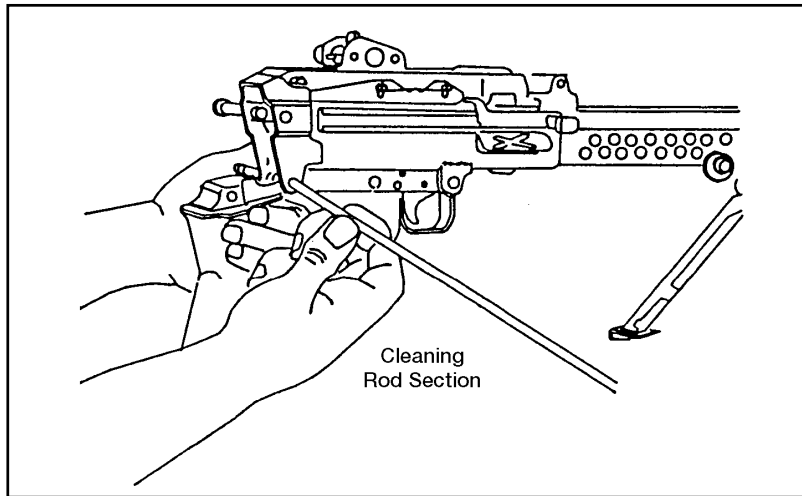
(2) While supporting the trigger mechanism with one hand, use the other to pull the buttstock and buffer assembly rearward and remove it (figure 071-312-4025-11).

---

---

**Performance Steps**

---



**Figure 071-312-4025-11. Removal of the buttstock and buffer assembly**

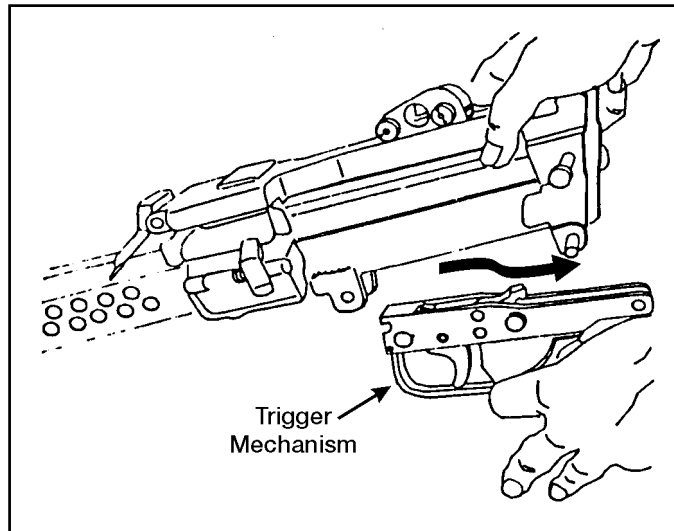
**h.** Remove the trigger mechanism by pulling rearward and down (figure 071-312-4025-12).

---

---

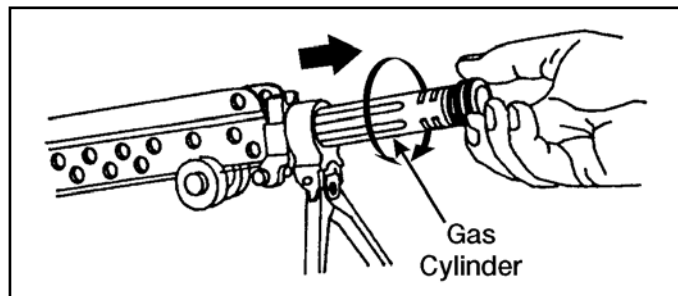
**Performance Steps**

---



**Figure 071-312-4025-12. Removal of the trigger mechanism**

- i. Remove the gas cylinder.
  - (1) Turn the gas cylinder to the left or right to release the locking spring.
  - (2) Pull the gas cylinder forward to remove it (figure 071-312-4025-13).



**Figure 071-312-4025-13. Removal of the gas cylinder**

---



---

**Performance Steps**

---

j. Remove the bipod. The bipod should slip off the receiver easily. If it does not, turn the bipod left or right to loosen any dirt or corrosion (figure 071-312-4025-14).

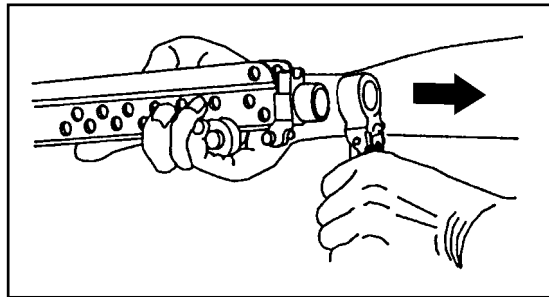


Figure 071-312-4025-14. Removal of the bipod

3. Clean the M249.

**WARNING**

Do not use gasoline, kerosene, hydraulic oil, benzene, benzol, high-pressure water, steam, or compressed air for cleaning.

**Note.** Do not use abrasives to clean the bore, piston, gas cylinder, or gas regulator.

**a.** Clean the bore and chamber using a bore brush, a chamber brush, CLP, and fresh swabs..

**b.** Clean the gas regulator using the scraper. Do not use CLP on the collar, gas block, or body.

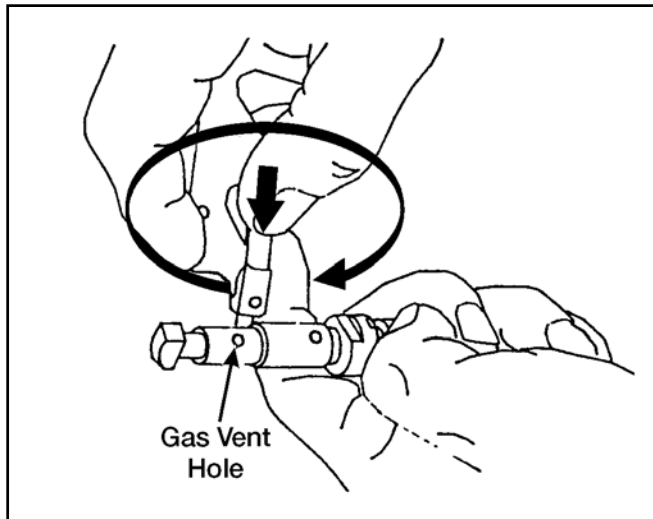
**(1)** Clean the gas vent hole (figure 071-312-4025-15).

---

---

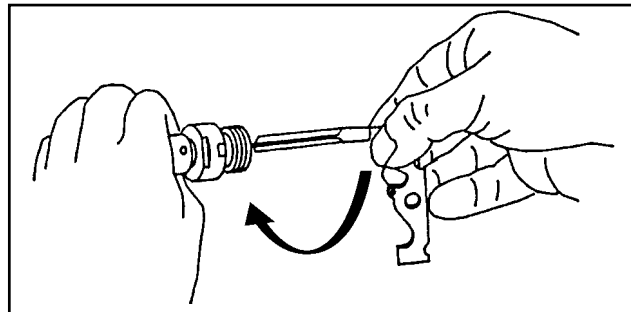
**Performance Steps**

---



**Figure 071-312-4025-15. Cleaning the gas vent hole**

**(2)** Clean the central hole of the gas regulator with the appropriate part of the scraper by turning the scraper clockwise and pushing it inward toward the bottom of the housing (figure 071-312-4025-16).



**Figure 071-312-4025-16. Cleaning the central hole**

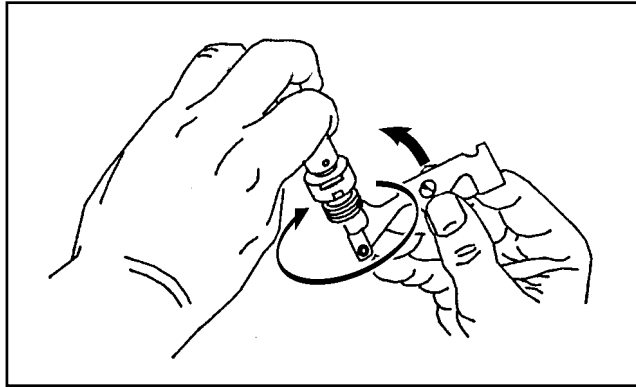
**(3)** Clean the two grooves of the regulator body using the protruding tips of the scraper (figure 071-312-4025-17).

---

---

**Performance Steps**

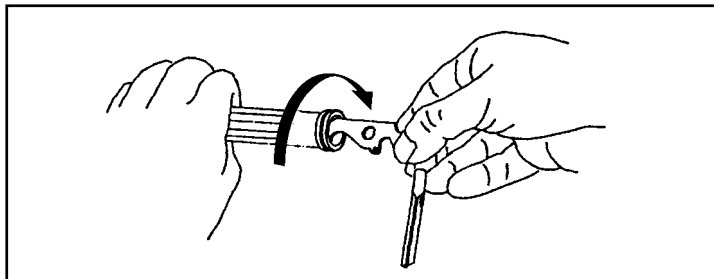
---



**Figure 071-312-4025-17. Cleaning the grooves of the regulator body**

**c.** Clean the gas cylinder and piston using the scraper. Do not use CLP on the gas cylinder or on the piston.

**(1)** Clean the front interior of the gas cylinder (repositioned in receiver with bipod in place) by inserting and turning the flat side of the scraper in a full 360-degree circular motion (figure 071-312-4025-18).



**Figure 071-312-4025-18. Cleaning the gas cylinder's front interior**

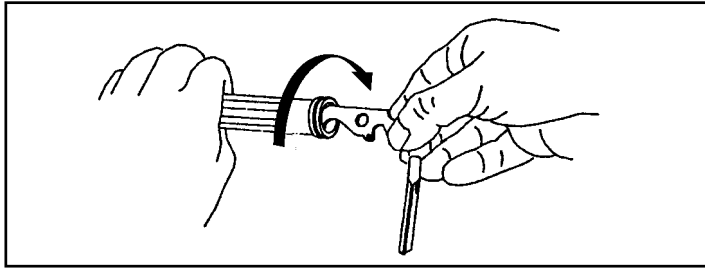
**(2)** Clean the internal grooves on the front side of the gas cylinder as previously described (using the protruding tips of the scraper), but insert the scraper farther into the gas cylinder (figure 071-312-4025-19).

---

---

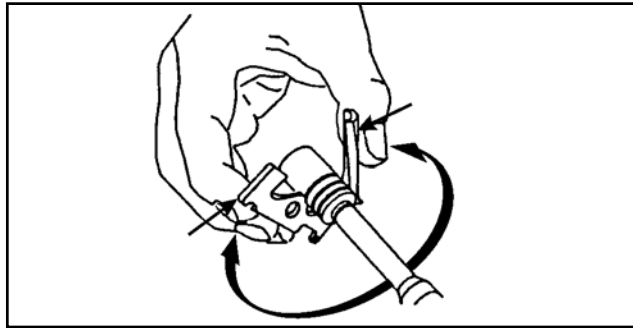
**Performance Steps**

---



**Figure 071-312-4025-19. Cleaning the gas cylinder's internal grooves**

**(3)** Clean the three grooves of the piston using a full, 360-degree circular motion (figure 071-312-4025-20).



**Figure 071-312-4025-20. Cleaning the grooves of the piston**

**(4)** Clean the hole in the front of the piston by inserting and turning the flat side of the scraper in a full 360-degree circular motion (figure 071-312-4025-21).

---



---

**Performance Steps**

---

**k.** Check the safety function. Push the safety to the right (RED BAND NOT VISIBLE). Pull the trigger; the sear will not lower. Push the safety to the left (RED BAND VISIBLE). Pull the trigger again; the sear will lower.

**l.** Check the slide assembly, bolt assembly, piston assembly, and return rod and transfer mechanism assembly for burrs, cracks, and broken pins. Push down on roller of slide assembly to ensure it retracts. Check the driving spring for broken strands.

**m.** Check bipod legs for correct operation.

**n.** Check the rear sight assembly for serviceability.

**o.** Check the ammunition box for damage. Make sure the box latch will engage the receiver dovetail.

**p.** Inspect ammunition.

**(1)** Check for damaged, corroded, or loose bullets.

**(2)** Check for damaged links.

**(3)** Report to your squad leader or NCOIC any deficiencies you cannot correct.

**5.** Lubricate the M249.

**Note.** Use only CLP on the M249.

**a.** Lubricate exposed metal parts and all moving parts with a light coat of CLP.

**b.** Do not lubricate the gas regulator hole in the barrel or the gas regulator itself.

**6.** Assemble the M249.

**a.** Replace the bipod and gas cylinder.

**(1)** Place the bipod on the receiver.

**(2)** Push the gas cylinder through the bipod yoke into the receiver.

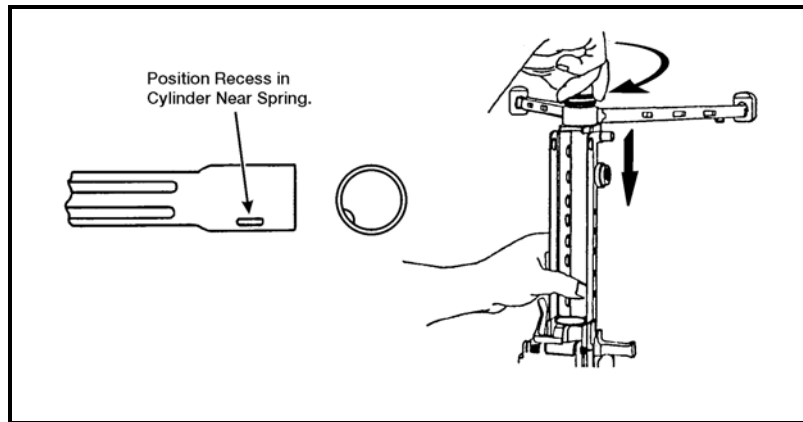
**(3)** Push the cylinder to the rear while countering the pressure of the locking spring and guiding the end of the cylinder into the receiver with the other hand applying downward pressure. When you have fully inserted the gas cylinder, rotate it until the spring clicks into place in the recess at the rear of cylinder (figure 071-312-4025-22).

---

---

**Performance Steps**

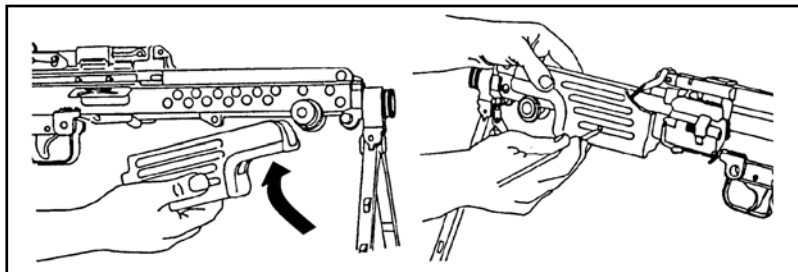
---



**Figure 071-312-4025-22. Replacement of the bipod and gas cylinder**

**b. Replace the handguard.**

- (1) Stow the cleaning equipment in the handguard.
- (2) Place the handguard onto the receiver and slide it backward until it stops.
- (3) Using a cleaning rod section, push the handguard retaining pin to the right. This locks the handguard into position (figure 071-312-4025-23).



**Figure 071-312-4025-23. Replacement of the handguard**

- (4) Pull downward on the handguard to ensure it locks into position.

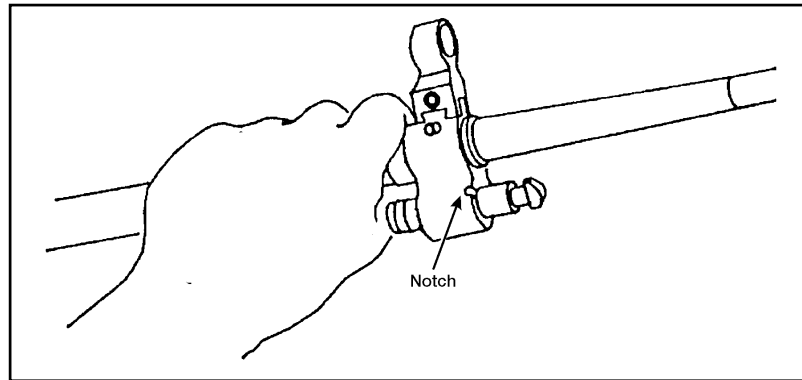
**c. Replace the gas regulator.**

- (1) Insert the gas regulator into the lower end of the hole in the gas block. Align the notch on the gas regulator body with the notch in the gas block (figure 071-312-4025-24).
-

---

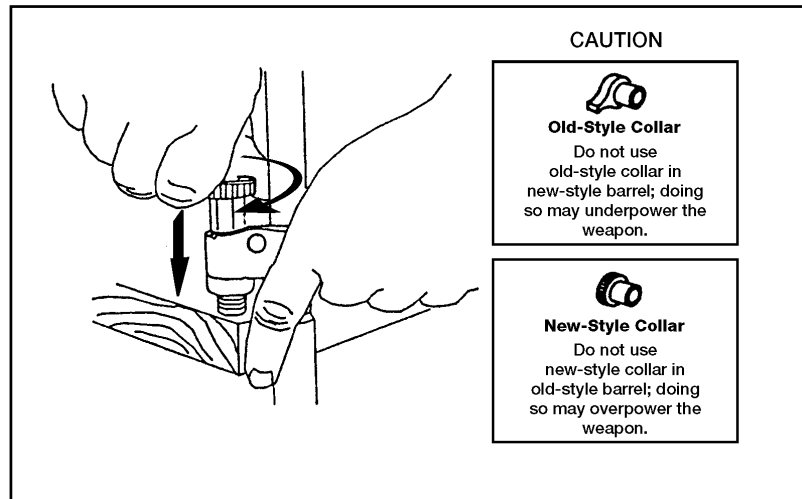
**Performance Steps**

---



**Figure 071-312-4025-24. Replacement of the gas regulator**

(2) With the gas regulator installed and supported on a firm surface, place the gas collar on the protruding end of the gas regulator. Rotate the gas collar until it slips in place. To lock the gas regulator in place, press it in and rotate it (figure 071-312-4025-25).



**Figure 071-312-4025-25. Replacement of the gas collar**

**d. Replace the barrel.**

---

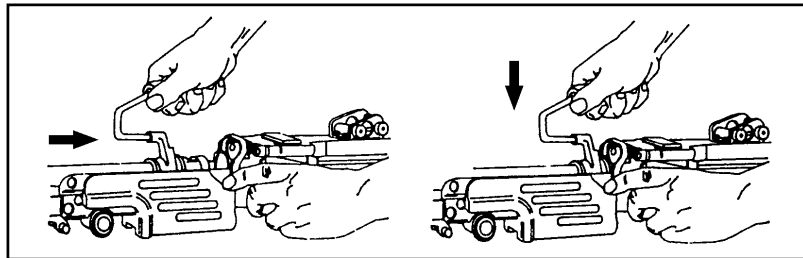


---

**Performance Steps**

---

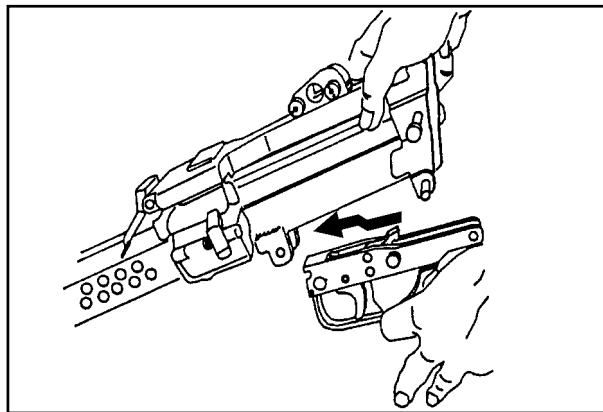
(1) Depress the barrel locking lever with your left hand (figure 071-312-4025-26).



**Figure 071-312-4025-26. Replacement of the barrel**

(2) Hold the carrying handle with your right hand; pull the barrel rearward into the receiver. Push the carrying handle downward and release the barrel locking lever. Check to ensure the barrel locks into position.

e. Replace the trigger mechanism (figure 071-312-4025-27).



**Figure 071-312-4025-27. Replacement of trigger mechanism**

(1) Pull the retaining pin to the left side of the receiver.

(2) Align the trigger mechanism with the slot on the bottom of the receiver. To hold the trigger mechanism in place, push the lower retaining pin into the right side hole on the rear of the trigger mechanism assembly.

---

---

**Performance Steps**

---

f. Replace the buttstock and shoulder assembly (figure 071-312-4025-28). Support the trigger mechanism with your left hand. Align the lower hole in buttstock and buffer assembly with the rear hole in the trigger mechanism. Push the lower retaining pin to the right.

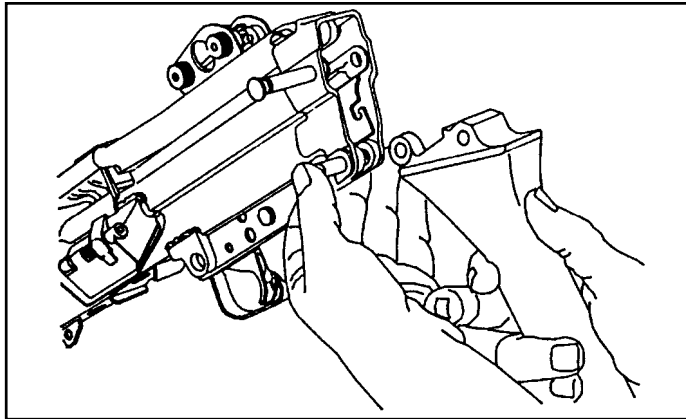


Figure 071-312-4025-28. Replacement of the buttstock and shoulder assembly

g. Replace the operating rod, slide assembly, and bolt assembly.

(1) Secure the slide assembly to the piston by pushing the retaining pin from the left to the right. Place the firing pin spring on the firing pin (figure 071-312-4025-29).

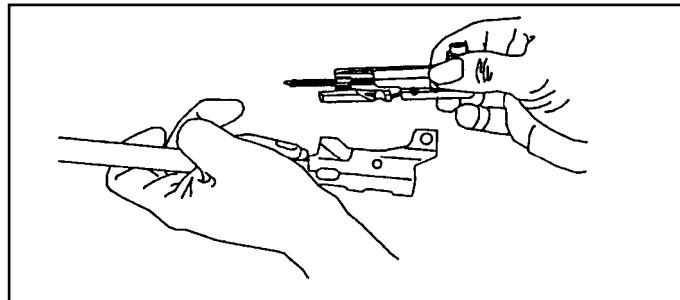


Figure 071-312-4025-29. Attachment of the slide assembly to the piston

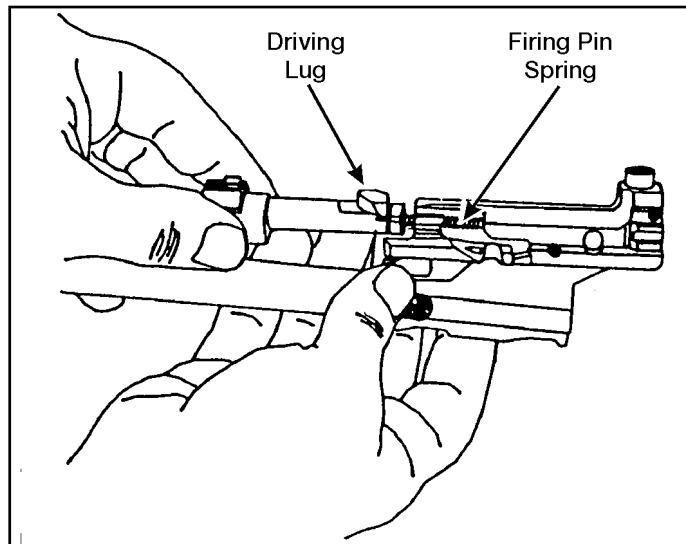
(2) Put the bolt assembly into the slide assembly. Press in to compress the firing pin spring. Rotate the bolt and hook its driving lug into the slide assembly (figure 071-312-4025-30).

---

---

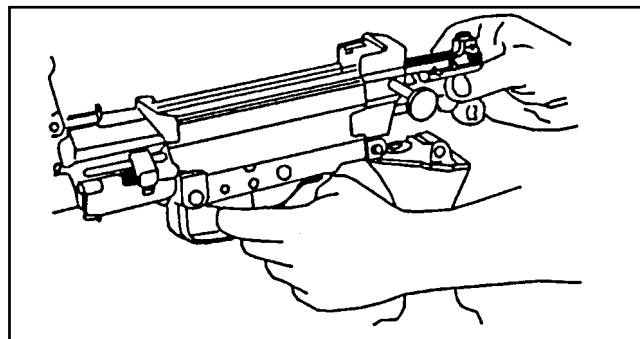
**Performance Steps**

---



**Figure 071-312-4025-30. Attachment of the bolt assembly to the slide assembly**

**(3)** Put the assembled parts into the receiver with the feed cover open. Align and place the bolt lugs; slide the cutouts carefully onto the receiver rails. Press the trigger and at the same time, push the parts all the way forward (figure 071-312-4025-31).



**Figure 071-312-4025-31. Replacement of the operating rod, slide assembly, and bolt assembly**

**h.** Replace the spring, return rod, and transfer mechanism assembly.

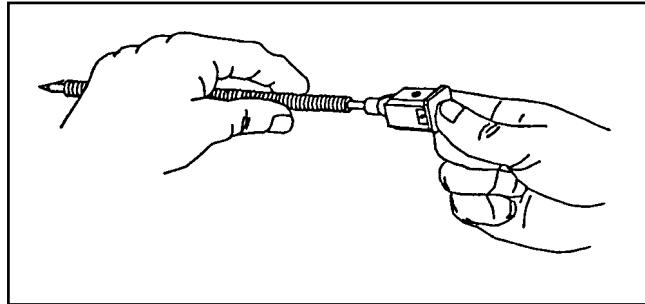
---

---

**Performance Steps**

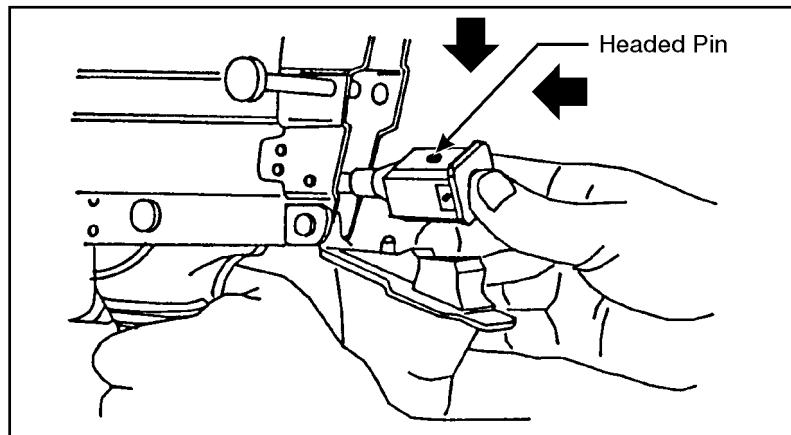
---

(1) Put the slide spring on the return rod and transfer mechanism assembly (figure 071-312-4025-32).



**Figure 071-312-4025-32. Replacement of the spring**

(2) Ensure that the headed end of the vertical pin in the transfer mechanism assembly points upward (on top of the transfer mechanism assembly) (figure 071-312-4025-33).



**Figure 071-312-4025-33. Replacement of the return rod and transfer mechanism assembly**

(3) Hold the pistol grip with one hand. With the other hand, push the return rod and transfer mechanism assembly into its housing in the piston. Press inward and downward on the rear of the assembly until its two lugs move into the receiver grooves.

---

---

**Performance Steps**

---

- i. Pivot the buttstock and buffer assembly upward into position. Push the retaining pin to the right, and close the cover assembly (figure 071-312-4025-34).

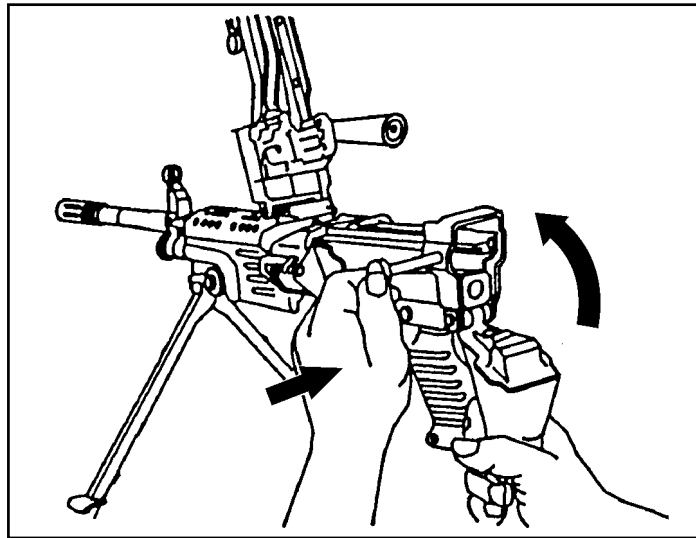


Figure 071-312-4025-34. Replacement of buttstock and buffer assembly

- j. Replace the heat shield assembly (figure 071-312-4025-35).

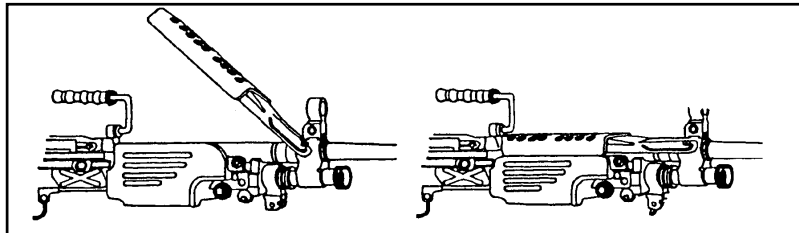


Figure 071-312-4025-35. Replacement of the heat shield assembly

- (1) Hook the metal extensions of the heat shield assembly under the front sight pins (new style barrel) with the spring clips down on top of the barrel.
-

---

**Performance Steps**

---

**Note.** Although old style barrels do not have protruding front sight pins, you can still install heat shield assemblies on them.

(2) Apply downward pressure and snap the heat shield onto the barrel. Be careful not to pinch yourself.

7. Perform a function check to ensure you have assembled the weapon correctly.

---

**Evaluation Preparation:**

*Setup:* At the test site, provide all the equipment and materials listed in task conditions. Use only dummy ammunition for training purposes.

*Brief Soldier:* Tell the soldier to perform maintenance on the M249, ammunition box, and linked 5.56-mm ammunition.

Performance Measures	GO	NO GO
1. Cleared the weapon.	___	___
2. Disassembled the weapon without damaging any parts.	___	___
3. Cleaned the weapon, ammunition box, and ammunition.	___	___
4. Identified any damaged, worn, or malfunctioning part.	___	___
5. Identified any damaged ammunition.	___	___
6. Lubricated the weapon using the correct lubrication technique.	___	___
7. Assembled the weapon in correct sequence without damaging any parts.	___	___

**Evaluation Guidance:** Score the soldier GO if all performance measures are passed. Score the soldier NO GO if any performance measure is failed. If the soldier scores NO GO, show him what was done wrong and how to do it correctly.

**References**

**Required**  
TM 9-1005-201-10

**Related**  
FM 3-22.68

---

## 071-312-4027

### Load an M249 Machine Gun

**Conditions:** Given an M249 machine gun, small arms ammunition box, and linked 5.56-mm ammunition.

**Standards:** Attached the ammunition box to the receiver correctly. Placed linked 5.56-mm ammunition in the feed tray groove so that, when the cover was closed, a round remained in the tray groove and the ammunition was fed correctly.

---

#### Performance Steps

1. With the palm facing up, pull the cocking handle to the rear. This locks the bolt in the rear position.
2. Push the cocking handle forward until you hear it click into the locked position (figure 071-312-4027-1).

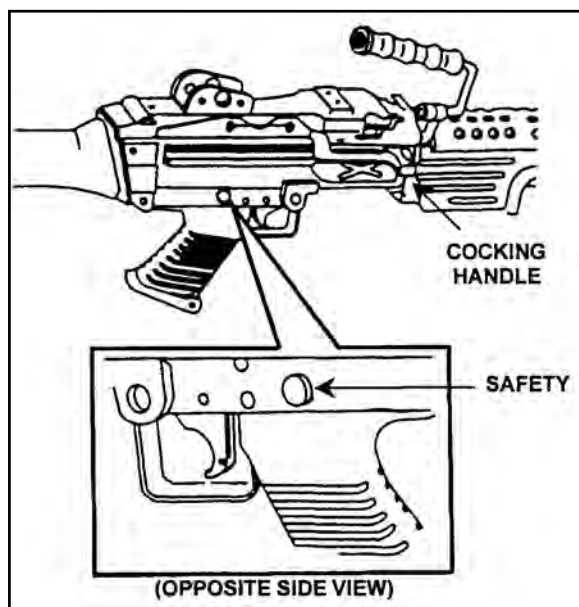


Figure 071-312-4027-1. M249 locking handle and safety

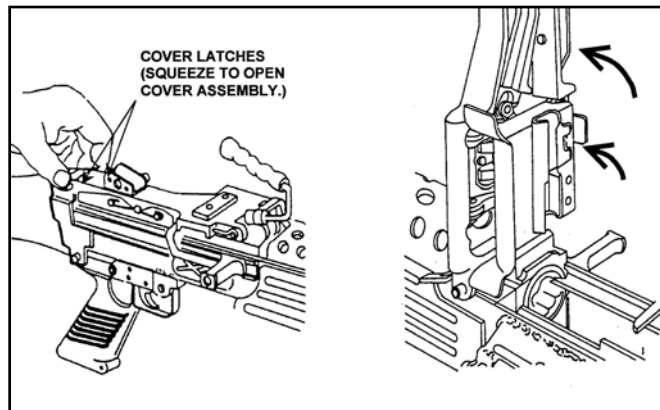
3. Push the safety from left to right for safe mode (the red band will not show) (figure 071-312-4027-1).

---

**Performance Steps**

---

4. Open the cover, raise the feed tray assembly, and make sure that the feed tray, receiver, and chamber area are clear (figure 071-312-4027-2).



**Figure 071-312-4027-2. Checking the feed tray, receiver, and chamber area**

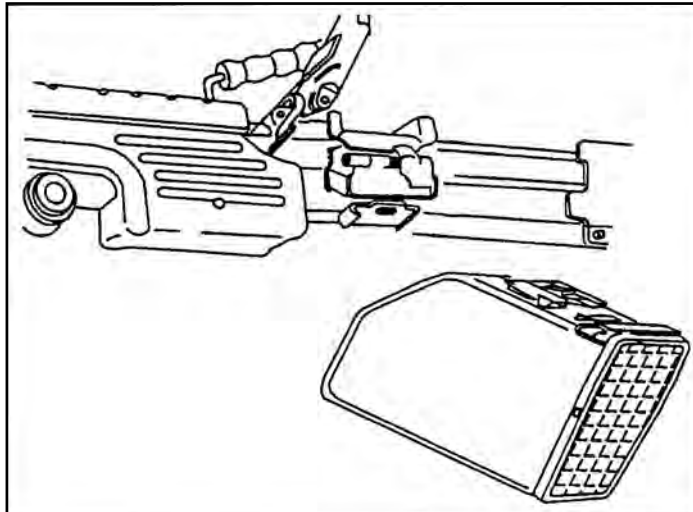
5. Attach the ammunition box with linked 5.56-mm ammunition to the underside of the receiver. To do so, align the box latch with the dovetail on the receiver (figure 071-312-4027-3). Pull outward on the ammunition box to make sure the aligning box latch engages.
-



---

**Performance Steps**

---



**Figure 071-312-4027-3. Attachment of the ammunition box**

6. Place the link belt in the feed tray with the first round against the cartridge stop and hold the belt in place. Close the cover assembly (figure 071-312-4027-4).
-

**Performance Steps**

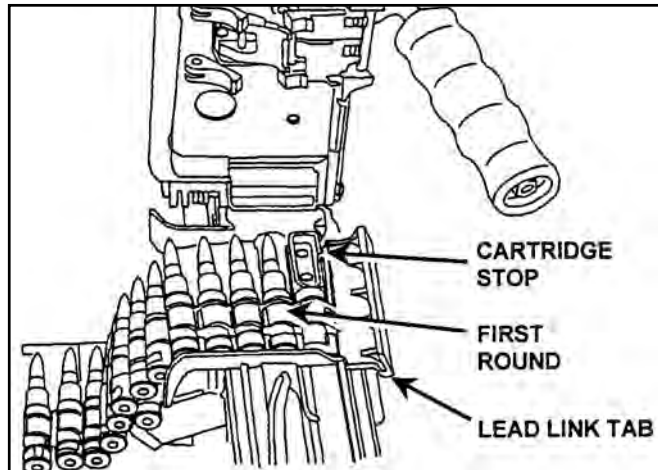


Figure 071-312-4027-4. Link belt in feed tray

**WARNING**

The weapon is now loaded.

**Evaluation Preparation:**

*Setup:* Use dummy ammunition to test this task. At the test position, provide an M249 and a belt of linked, dummy 5.56-mm ammunition. For standardization, always place the bolt and cocking handle forward and the safety in the safe position. Make sure the ammunition is clean and linked properly. Have an assistant relink and wipe the ammunition clean before the next test.

*Brief Soldier:* Tell the soldier to load the M249 machine gun.

Performance Measures	GO	NO GO
1. Locked the bolt in the rear position.	___	___
2. Pushed the cocking handle forward to the locked position.	___	___
3. Pushed the safety to the safe position.	___	___
4. Checked to make sure the feed tray, receiver, and chamber were clear.	___	___

Performance Measures	GO	NO GO
5. Attached the ammunition box with linked ammunition to the receiver.	___	___
6. Placed the link belt in the feed tray with the first round against the cartridge.	___	___
7. Closed the cover.	___	___

**Evaluation Guidance:** Score the soldier GO if all performance measures are passed. Score the soldier NO GO if any performance measure is failed. If the soldier scores NO GO, show the soldier what was done wrong and how to do it correctly.

**References**

**Required**

**Related**

FM 3-22.68

TM 9-1005-201-10

---

**071-312-4028**

**Unload an M249 Machine Gun**

**Conditions:** Given an M249 machine gun loaded with 5.56-mm ammunition (linked or in an M16 magazine) and a requirement to unload the M249.

**Standards:** Removed all ammunition, expanded brass, links, and the magazine from the weapon.

---

**Performance Steps**

1. Pull the cocking handle to the rear, locking the bolt in the rear position.
  2. Place the safety in the safe mode (the red band will not show) and return the cocking handle to its forward position.
  3. Remove ammunition and links.
    - a. Belt-fed. Raise the cover and remove any ammunition or links from the feed tray.
    - b. Magazine-fed. Push down on the magazine release tab and pull the magazine out. Then raise the cover.
  4. Raise the feed tray and inspect the chamber to ensure that it contains no ammunition. If it contains ammunition, remove the ammunition.
  5. Close the cover.
  6. Place the safety in the fire mode (the red band will show).
  7. Pull the cocking handle to the rear, and pull the trigger while manually
-

---

**Performance Steps**

---

easing the bolt forward to the closed position.

---

**Evaluation Preparation:**

*Setup:* At the test site, provide the soldier with all the equipment given in the task conditions. Evaluate this task using dummy 5.56-mm linked rounds or dummy 5.56-mm ammunition loaded in 30-round M16 magazines.

*Brief Soldier:* Tell the soldier to unload the M249 in the correct manner.

Performance Measures	GO	NO GO
1. Pulled the cocking handle to the rear, locking the bolt in the rear position.	___	___
2. Placed the safety in safe mode (the red band will not show) and returned the cocking handle to its forward position.	___	___
3. Removed ammunition and links.	___	___
a. Belt-fed. Raised the cover and removed any ammunition or links from the feed tray.		
b. Magazine-fed. Pushed down on the magazine release tab and pulled the magazine out. Then raised the cover.		
4. Raised the feed tray and inspected the chamber to ensure that it contained no ammunition. If it contained ammunition, removed the ammunition.	___	___
5. Closed the cover.	___	___
6. Placed the safety in the fire mode (the red band will show).	___	___
7. Pulled the cocking handle to the rear, and pulled the trigger while manually easing the bolt forward to the closed position.	___	___

**Evaluation Guidance:** Score the soldier GO if all performance measures are passed. Score the soldier NO GO if any performance measure is failed. If the soldier scores NO GO, show the soldier what was done wrong and how to do it correctly.

**References****Required****Related**

FM 3-22.68

3-380

071-312-4028

**SUBJECT AREA 12: M60 MACHINE GUN**

**071-312-3025**

**Maintain an M60 Machine Gun**

**Conditions:** Given an M60 machine gun that needs to be cleaned and inspected. You have a cleaning kit, cleaner lubricant preservative (CLP), lubricating oil arctic weather (LAW), swabs, a dummy cartridge, and a field table or ground cloth on which to work.

**Standards:**

1. Disassembled the M60 machine gun into the following groups: stock; buffer and operating rod; bolt assembly; trigger mechanism; barrel; feed cover, feed tray, and hanger; forearm; and receiver.
2. Cleaned the M60 machine gun, removed powder fouling and other foreign material and identified any unserviceable parts. Did not get CLP in the gas cylinder.
3. Lubricated the M60 machine gun.
4. Assembled the M60 machine gun, performed a function check, ensured the forearm group was locked in place, the hinge pin was interlocked with the latch engaging the sear pin, and the stock group latch engaged.

**Performance Steps**

**WARNING**

Weapon must be clear before disassembling.

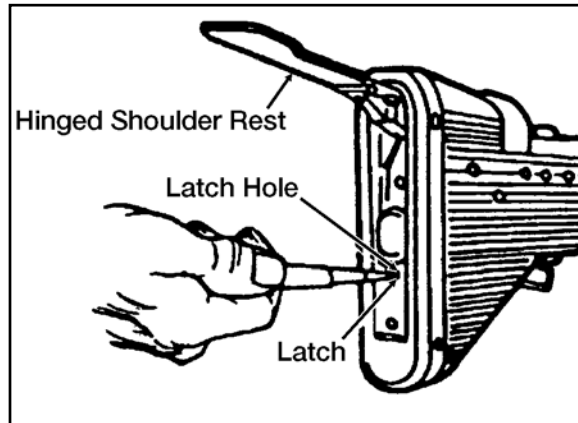
1. Clear the M60 machine gun.
  - a. Pull the cocking handle to the rear.
  - b. Lock the bolt to the rear.
  - c. Raise the feed cover.
  - d. Ensure the chamber is empty.
  - e. Close the feed cover.
  - f. Place the safety lever on FIRE.
  - g. Pull the cocking handle to the rear and hold it.
  - h. Pull the trigger and allow the bolt to ease forward.
  - i. Place the selector lever on SAFE.
2. Remove the stock group.
  - a. Raise the hinged shoulder rest.

---

**Performance Steps**

---

**b.** Insert the nose of a dummy cartridge into the latch hole (figure 071-312-3025-1).



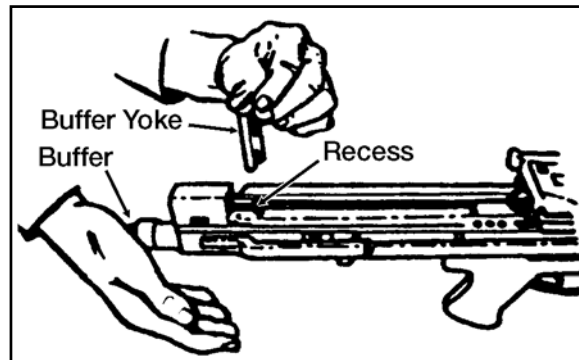
**Figure 071-312-3025-1. Stock**

- c.** Push the latch down.
  - d.** Pull the stock group to the rear, removing it from the M60 machine gun.
- 3.** Remove the buffer, operating rod, and bolt assembly group.
- a.** Remove the buffer.
    - (1)** Press the exposed buffer lightly with the palm of the hand (figure 071-312-3025-2).
-

---

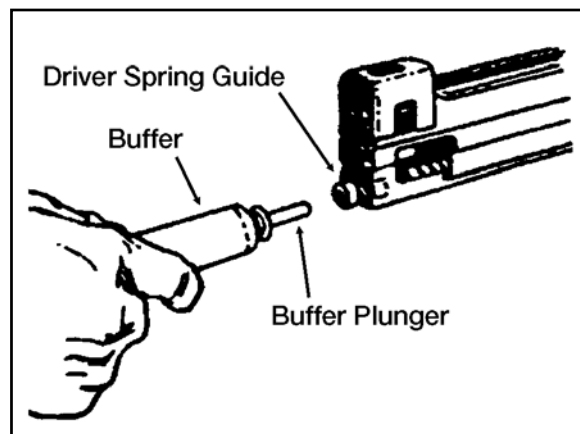
**Performance Steps**

---



**Figure 071-312-3025-2. Buffer yoke**

- (2) Remove the buffer yoke from the top of the receiver.
- (3) Remove the buffer slowly by pulling it rearward. Allow the driver spring guide to expand until the end of the guide is showing at the rear of the receiver.
- (4) Pull the buffer plunger from the driver spring guide (figure 071-312-3025-3).



**Figure 071-312-3025-3. Buffer**

- (5) Pull the driver spring guide and spring from the receiver.
- (6) Separate the driver spring from the driver spring guide.

---

**Performance Steps**

---

- b. Remove the operating rod and bolt.
- (1) Grasp the pistol grip with the left hand.
  - (2) Pull the cocking handle to the rear with your right hand until the bolt separates from the barrel socket.
  - (3) Return the cocking handle to the forward position.
  - (4) Pull the cam roller until it stops. This pulls the rod and bolt to the rear.
  - (5) Push the bolt to the rear with your finger on the face of the bolt (figure 071-312-3025-4).

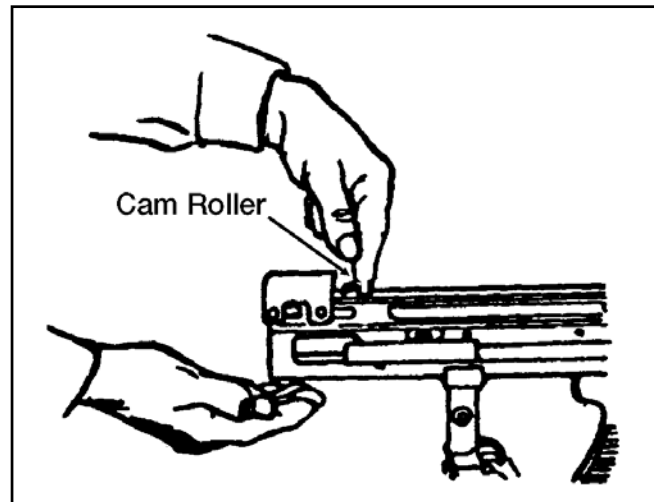


Figure 071-312-3025-4. Cam roller

---



---

**Performance Steps**

---

(6) Grasp the operating rod and bolt when they are about 4 inches out of the cylinder to prevent the bolt from rotating.

(7) Pull the operating rod and bolt from the receiver (figure 071-312-3025-5).

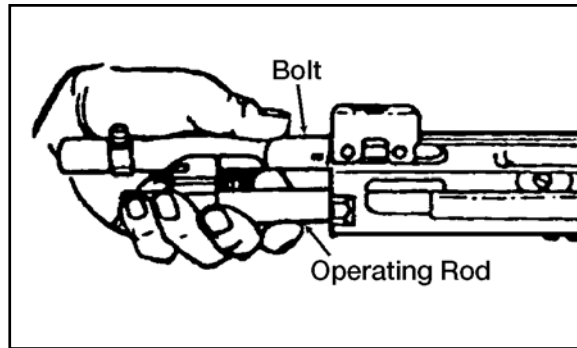


Figure 071-312-3025-5. Operating rod and bolt

(8) Relax your grip, allowing the bolt to rotate slowly.

(9) Grasp the bolt and operating rod with both hands. The bolt should be on the bottom, facing away from your body.

(10) Disengage the bolt from the operating rod by pulling forward on the operating handle and lifting upward (figure 071-312-3025-6).

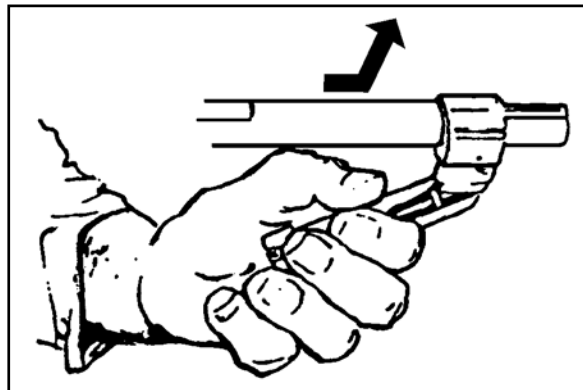


Figure 071-312-3025-6. Bolt assembly and operating rod being separated

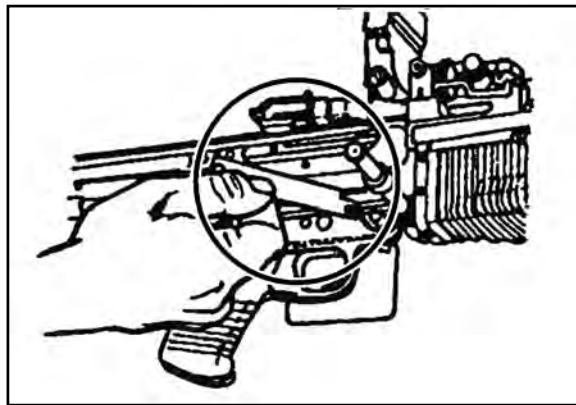
---

---

**Performance Steps**

---

4. Remove the trigger mechanism group consisting of the grip, leaf spring, and retaining pin.
  - a. Press in on the rear of the leaf spring.
  - b. Rotate the rear of the leaf spring up to clear it from the sear pin (figure 071-312-3025-7).



**Figure 071-312-3025-7. Sear pin**

- c. Pull the leaf spring to the rear, disengaging it from the front notch of the retaining pin.
    - d. Remove the retaining pin by pushing it to the left.
    - e. Remove the trigger mechanism.
      - (1) Slide the trigger mechanism slightly forward.
      - (2) Rotate the front of the trigger mechanism housing down.
      - (3) Remove the trigger mechanism (figure 071-312-3025-8).
-

---

Performance Steps

---

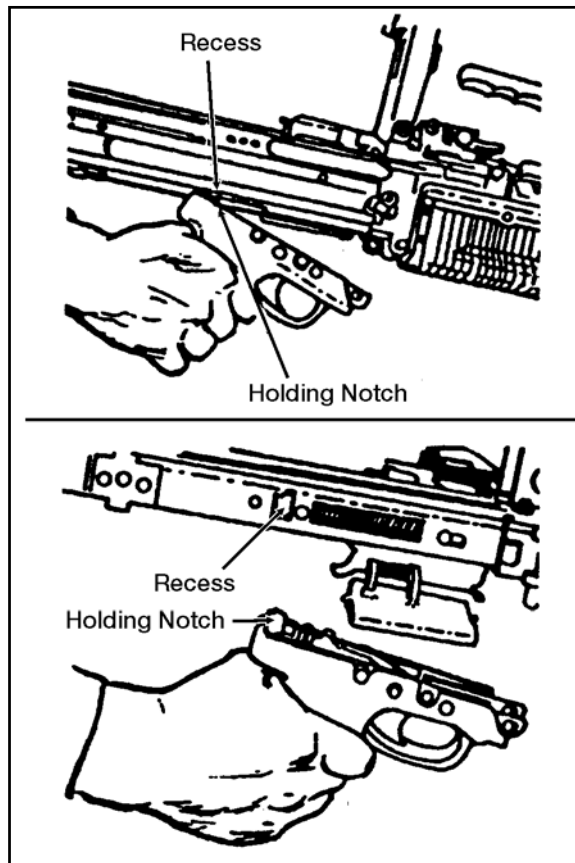


Figure 071-312-3025-8. Trigger mechanism group

5. Remove the cover, feed tray, and hanger group.
    - a. Remove the feed cover.
      - (1) Raise the feed cover.
      - (2) Unlock the hinge pin using a pointed object (figure 071-312-3025-9).
-

---

Performance Steps

---

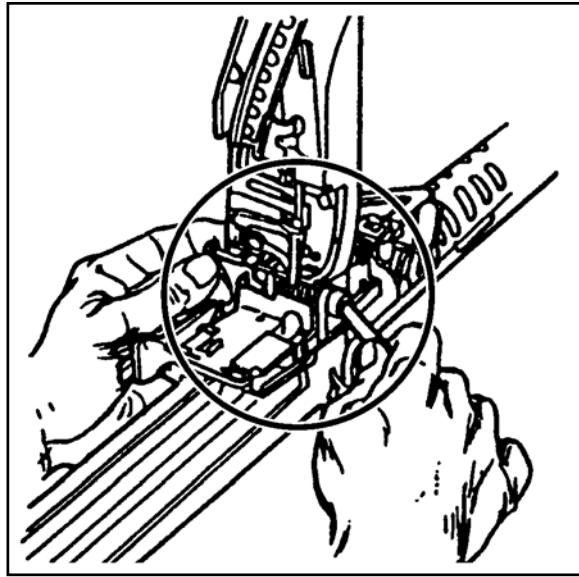


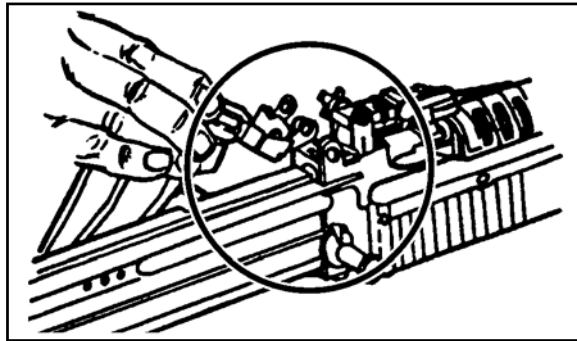
Figure 071-312-3025-9. Hinge pin latch

- (3) Push the hinge pin out of its recess and remove it from the opposite side of the hinge pin latch.
  - (4) Lift the feed cover from the receiver assembly.
  - (5) Remove the feed cover spring from the cover.
    - b. Lift the feed tray and hanger group from the receiver assembly (figure 071-312-3025-10).
-

---

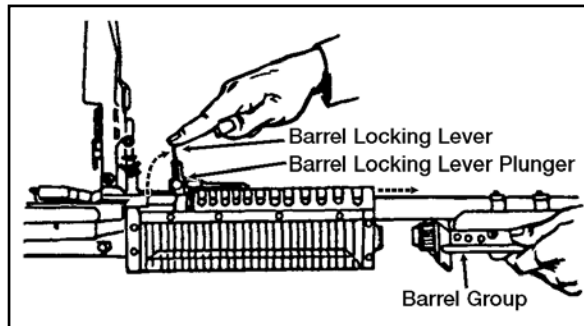
**Performance Steps**

---



**Figure 071-312-3025-10. Feed tray and hanger group**

- 6.** Remove the barrel group, made up of the barrel, flash suppressor, front sight, bipod assembly, and gas cylinder system.
  - a.** Push in on the barrel locking lever plunger (figure 071-312-3025-11).



**Figure 071-312-3025-11. Barrel locking lever**

- b.** Raise the barrel locking lever to the vertical position.
    - c.** Remove the barrel group by pulling it straight to the front of the rifle.
  - 7.** Remove the forearm assembly.
    - a.** Turn the receiver so the top is facing down.
    - b.** Insert a pointed object into the latch hole at the bottom rear of the forearm assembly (figure 071-312-3025-12).
-

---

Performance Steps

---

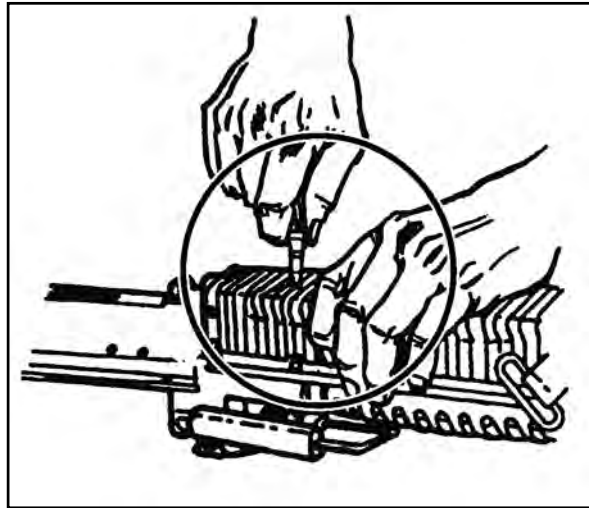


Figure 071-312-3025-12. Forearm latch

- c. Release the forearm latch by pressing downward with a pointed object.
- d. Raise the rear of the forearm assembly slightly.
- e. Pull the forearm assembly to the front to remove it.

**Note.** This completes general disassembly of the M60 machine gun. The receiver group requires no disassembly.

**8.** Clean the M60 machine gun.

**CAUTION**

Do not use gasoline, kerosene, benzene, or high pressure water, steam, or air for cleaning.

- a. Position the gas cylinder above the barrel during cleaning so as not to get CLP in the gas cylinder.
  - b. Clean the bore using CLP and a bore brush attached to a cleaning rod.
    - (1) Run the brush through the bore without reversing the direction of the brush while it is in the bore.
    - (2) Repeat the preceding step until most of the powder fouling and other foreign matter have been removed.
-

---

**Performance Steps**

---

- (3) Swab out the bore several times using a cleaning rod and a swab wet with CLP.
    - (4) Swab out the bore several times using a cleaning rod and a dry swab.
  - c. Clean the chamber using CLP and a chamber brush attached to a cleaning rod.
    - (1) Run the brush through the chamber.
    - (2) Repeat the preceding step until most of the powder fouling and other foreign matter have been removed.
    - (3) Swab out the chamber several times using a cleaning rod and a swab wet with CLP.
    - (4) Swab out the chamber several times using a cleaning rod and dry swab.
  - d. Clean the receiver with a receiver brush and CLP.
    - (1) Brush the receiver until most of the powder fouling and other foreign matter have been removed.
    - (2) Swab out the receiver several times using a cleaning rod and a swab wet with CLP.
    - (3) Swab out the receiver several times using a cleaning rod and dry swab.
  - e. Clean the buffer and operating rod group using CLP and a receiver brush. Do not submerge the buffer in any cleaning solvents.
    - (1) Brush the buffer group until powder fouling and other foreign matter have been removed.
    - (2) Swab out the operating rod several times using a cleaning rod and a swab wet with CLP.
    - (3) Swab out the operating rod several times using a cleaning rod and a dry swab.
  - f. Wipe down all parts of the M60 machine gun except the rubber-coated parts with a rag wet with CLP.
  - g. Dry all parts cleaned with CLP.
9. Inspect the parts for serviceability.
  - a. Stock group.
    - (1) Ensure the stock group fits securely on the receiver.
    - (2) Check the guide rails for cracks, bends, or burrs.
    - (3) Check the shoulder rest and stock latch for binding.

---

**Performance Steps**

---

(4) Check the rubber coating for gumming or cracking.

**b. Buffer and operating rod group.**

(1) Check the yoke and yoke recess for burrs, cracks, or bends.

(2) Ensure the buffer plunger fits easily into the recess in the driver spring guide.

(3) Check the driver spring for kinks and broken or separated wires.

(4) Check the driver spring guide for bends, ensuring the spool is tight on the shaft.

(5) Check the sear notch on the operating rod for excessive wear or burring.

**c. Bolt assembly group.**

(1) Check the bolt plug, bolt plug pin, and actuator cam assembly for chips and burrs.

(2) Check the firing pin for cracks or wear on the tip.

(3) Check the ejector and extractor to ensure they are under spring tension and are not chipped or worn.

**d. Trigger mechanism group.**

(1) Check the shoulder of the sear for excessive wear.

(2) Check the mechanism for cracks (check carefully near the retaining pins).

(3) Check the leaf spring to ensure it is under tension.

(4) Check the safety for correct function. (The sear should move only slightly when the safety lever is on SAFE, and freely when the safety lever is on FIRE.)

**e. Barrel group.**

(1) Check to ensure the suppressor is tight.

(2) Check the front sight and barrel locking-cam for bends, cracks, burrs, or excessive wear.

(3) Check the bipod assembly for correct functioning. (The legs should lock in the up and down position. The leg extension should lock at the desired heights.)

(4) Check the gas piston and gas cylinder for burrs.

(5) Check the detent on the tab lock washers of the gas cylinder nut and gas cylinder extension to ensure it is not broken.

(6) Check the bleeder hole in the gas cylinder extension to ensure it is clear.

---



---

**Performance Steps**

---

**f.** Feed cover, feed tray, and hanger.

(1) Check to ensure all parts inside the feed cover are under spring tension.

(2) Check the feed cover to ensure it is not bent or torn.

(3) Check the belt holding pawl to ensure it is under spring tension.

**g.** Forearm assembly.

(1) Check the assembly to ensure it is not bent.

(2) Check the spring in the latch to ensure it is not broken.

**h.** Receiver group.

(1) Check the receiver to ensure it is not bent or cracked.

(2) Check the cocking handle to ensure it slides freely within its guide path.

(3) Check the elevation scale on the rear sight to ensure it is legible. The elevation screw should not be burred or worn.

**10.** Lubricate the M60 machine gun.

**Note.** When lubricating the M60 machine gun at temperatures below 0 degrees Fahrenheit, use LAW and lubricate lightly to avoid freeze-ups; under all other conditions, use CLP. When using LAW, lubrication techniques are the same as for CLP.

**a.** Make sure you do not get CLP inside the buffer assembly or inside the gas cylinder.

**b.** Run a cleaning patch with several drops of CLP on it through the bore.

**c.** Wipe down all non-rubber-coated exterior surfaces of the M60 machine gun with a rag with several drops of CLP on it.

**d.** Use CLP to lubricate the following surfaces.

(1) Bolt locking lugs by the camming surfaces.

(2) Operating rod surfaces along the receiver rails.

(3) Actuator roller on the bolt and where the bolt actuator rides the feed pawl carrier on the underside of the cover assembly.

**11.** Assemble the M60 machine gun in the following order.

**a.** Assemble the forearm group.

(1) Guide the forearm assembly over the operating rod tube, ensuring the operating rod does not strike the baffles inside the forearm assembly.

---

---

**Performance Steps**

---

(2) Align the recess in the forearm assembly with the end of the operating rod tube.

(3) Tap up on the bottom rear of the forearm assembly with the palm of your hand to lock it in position.

**b.** Assemble the feed cover, feed tray, and hanger group.

(1) Align the guides of the feed tray and hanger on the left side of the cover mounting brackets and sear, the feed tray, and hanger in the receiver.

(2) Replace the cover.

(a) Insert the cover spring in the cover.

(b) Align the cover with the mounting brackets.

(c) Insert the hinge pin from the right side.

(d) Insert the hinge pin latch from the left side, making sure that the hinge pin and the hinge pin latch interlock.

**c.** Assemble the barrel group.

(1) Make sure the barrel locking lever is in the vertical position (figure 071-312-3025-11).

(2) Put the rear of the barrel through the forearm assembly.

(3) Align the gas cylinder nut with its recess in the forearm assembly.

(4) Lower the barrel locking lever to its most downward position.

**d.** Assemble the trigger mechanism group (figure 071-312-3025-8).

(1) Engage the holding notch of the trigger mechanism group in its recess in the bottom of the receiver (figure 071-312-3025-8).

(2) Rotate the front of the trigger mechanism up.

(3) Align the holes of the trigger mechanism with the mounting bracket on the receiver.

(4) Insert the retaining pin from the left.

(5) Attach the leaf spring by placing the open end of the leaf spring on the retaining pin.

(6) Engage the hooked end to the sear pin.

**e.** Assemble the bolt and operating rod group.

(1) Hold the bolt securely in one hand with the camming slot up. The face of the bolt should be toward the body.

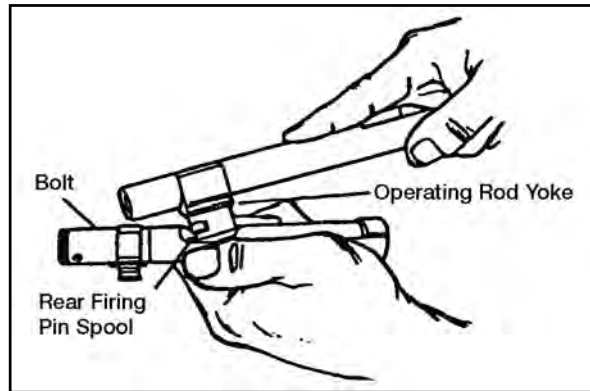
(2) Position the rear of the operating rod yoke against the rear firing pin spool with the other hand (figure 071-312-3025-13).

---

---

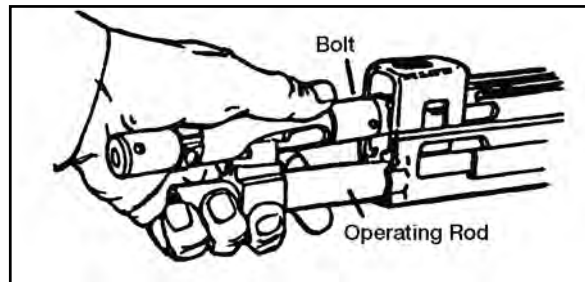
**Performance Steps**

---



**Figure 071-312-3025-13. Rear of operating rod yoke positioned against rear firing pin spool**

- (3) Push on operating rod, compressing the firing pin spring.
- (4) Position the operating rod yoke between the firing pin spool.
- (5) Push forward on the rear of the bolt with the other hand, causing the bolt to rotate until the locking lugs are vertical and the cam roller is up.
- (6) Push the operating rod and bolt (ensure the cam roller faces up) into the receiver until the end of the operating rod is even with the rear of the receiver (figure 071-312-3025-14).



**Figure 071-312-3025-14. Operating rod and bolt**

- (7) Put the driver spring guide into the driver spring.
  - (8) Put the free end of the driver spring in the opening of the operating rod.
-

---

**Performance Steps**

---

- (9) Pull the trigger.
- (10) Push in the driver spring until the head of the guide is about one inch from the receiver (figure 071-312-3025-3).
  - f. Assemble the buffer group (figure 071-312-3025-3).
    - (1) Put the buffer plunger into the driver spring guide.
    - (2) Push forward on the buffer until the operating rod and bolt go fully forward.
    - (3) Push in on the buffer until the recesses on the buffer are aligned with the recesses in the receiver.
    - (4) Place the buffer yoke in the buffer recess on top of the receiver.
  - g. Assemble the stock group.
    - (1) Align the guide rails of the stock group with the guide rails on the receiver.
    - (2) Push forward until the stock is fully seated. You will hear a distinct click when the latch engages.
- 12. Perform a function check to ensure that the M60 machine gun is assembled correctly.
  - a. Place the safety on FIRE.
  - b. Pull the cocking handle to the rear.
  - c. Return the cocking handle forward to the locked position.
  - d. Close the cover.
  - e. Place the safety on SAFE.
  - f. Pull the trigger; the weapon should not fire.
  - g. Place the safety on FIRE.
  - h. Pull the cocking handle to the rear, holding it in that position.
  - i. Pull the trigger, allowing the bolt to ease forward.
  - j. Store the weapon in the arms room or continue the mission.

---

**Evaluation Preparation:**

*Setup:* At the test site, provide one M60 machine gun, all required cleaning equipment, and a field table or ground cloth to work on.

*Brief Soldier:* Tell the soldier to disassemble, clean, assemble, and perform a function check on the machine gun.

Performance Measures	GO	NO GO
1. Cleared the weapon so the selector lever was on SAFE.	___	___

Performance Measures	GO	NO GO
2. Disassembled the weapon into the major groups without damaging any components.	—	—
3. Cleaned the weapon, removed the powder fouling and other foreign material and dried all components cleaned with CLP.	—	—
4. Identified any damaged, worn, or malfunctioning components.	—	—
5. Assembled the weapon in the correct sequence without damaging any components.	—	—
6. Performed a function check, ensured the weapon operated properly.	—	—

**Evaluation Guidance:** Score the soldier GO if all performance measures are passed. Score the soldier NO GO if any performance measure is failed. If the soldier scores NO GO, show him what was done wrong and how to do it correctly.

#### References

##### Required

FM 3-22.68

TM 9-1005-224-10

TM 9-1005-224-23&P

##### Related

---

## 071-312-3027

### Load an M60 Machine Gun

**Conditions:** Given a cleared M60 machine gun with a bipod and linked 7.62-mm ammunition. You must load the machine gun.

**Standards:** Loaded linked ammunition in the feed tray groove so, when the cover was closed, a round remained in the tray groove and ammunition fed correctly.

---

#### Performance Steps

**WARNING**

Keep all loaded weapons pointed in the direction of the target area.

- 
1. Place the safety on FIRE ("F").

---

**Performance Steps**

---

2. Open the bolt by pulling the cocking handle to the rear, locking the bolt to the rear with the palm of your hand facing up.
  3. Return the cocking handle to the forward position.
  4. Place the safety on SAFE ("S").
  5. Raise the cover.
  6. Ensure that the feed tray, receiver group, and chamber are clear.
  7. Place the first round of the belt in the feed tray groove, making sure the double link is leading with the open side of the link down.
  8. Hold the belt up (about six rounds from the loading end) while closing the cover, ensuring that the first round remains in the feed tray groove.
- 

**Evaluation Preparation:**

*Setup:* At the test position, place an M60 machine gun with bipod legs extended. Place a belt of linked dummy 7.62-mm ammunition with the machine gun. For standardization, have the bolt and cocking handle forward, the safety on S, and the belt of ammunition on top of the cover. Ensure the ammunition is clean and linked properly. Get an assistant to relink and wipe the ammunition clean for repeat testing.

*Brief Soldier:* Tell the soldier to load the M60 machine gun.

Performance Measures	GO	NO GO
1. Placed the safety on "F."	___	___
2. Pulled the cocking handle to the rear position with the palm up.	___	___
3. Returned the cocking handle to the forward position.	___	___
4. Placed the safety on "S."	___	___
5. Raised the cover.	___	___
6. Ensured the feed tray, receiver group, and chamber are clear.	___	___
7. Placed first round in the feed tray groove.	___	___
8. Held the belt up while closing the cover.	___	___
9. Closed the cover so the first round remained in the feed tray groove.	___	___
10. Completed performance measures 1 through 9 in sequence.	___	___

**Evaluation Guidance:** Score the soldier GO if all performance measures are passed. Score the soldier NO GO if any performance measure is failed. If the soldier scores NO GO, show the soldier what was done wrong and how to do it correctly.

**References**

**Required**

FM 3-22.68

TM 9-1005-224-10

**Related**

---

**071-312-3028**

**Unload an M60 Machine Gun**

**Conditions:** Given an M60 machine gun with a bipod, loaded with linked 7.62-mm ammunition. You need to unload the weapon.

**Standards:** Removed all ammunition and links from the machine gun. Cleared the weapon, ensuring the chamber was empty and the safety was on SAFE ("S").

---

**Performance Steps**

**WARNING**

Keep the M60 machine gun oriented on the target area while unloading.

1. Remove the ammunition from the M60 machine gun.
    - a. Pull the cocking handle to the rear, ensuring that the bolt is locked to the rear.
    - b. Place the safety lever on "S."
    - c. Return the cocking handle to its forward position.
    - d. Raise the cover.
    - e. Remove any ammunition or links from the tray.
    - f. Raise the feed tray.
    - g. Look into the chamber to ensure it is empty.
  2. Clear the weapon.
    - a. Confirm that no ammunition is in the chamber.
    - b. Close the cover.
    - c. Place the safety on FIRE ("F") .
-

---

**Performance Steps**

---

- d. Pull the cocking handle to the rear; hold it.

**CAUTION**

The bolt must be eased forward to prevent damage to the feed tray assembly and operating rod assembly. Do not close the cover with the bolt forward.

- e. Pull the trigger, allowing the bolt to ease forward.  
f. Place the safety on "S" (SAFE).
- 

**Evaluation Preparation:**

*Setup:* At the test site, place an M60 machine gun loaded with a belt of five or more rounds of linked ammunition. Have the bipod legs extended. For standardization, begin with the bolt forward and the safety on F (FIRE).

*Brief Soldier:* Tell the soldier to assume the prone position.

Performance Measures	GO	NO GO
1. Removed the ammunition from the M60 machine gun.	___	___
a. Pulled the cocking handle to the rear, ensuring that the bolt was locked to the rear.		
b. Placed the safety lever on "S" (SAFE).		
c. Returned the cocking handle to the forward position.		
d. Raised the cover.		
e. Removed any ammunition or links from the tray.		
f. Raised the feed tray.		
g. Looked into the chamber to ensure it was empty.		
2. Cleared the M60 machine gun.	___	___
a. Confirmed that no ammunition was in the chamber.		
b. Closed the cover.		
c. Placed the safety on "F" (FIRE).		
d. Pulled the cocking handle to the rear; held it.		
e. Pulled the trigger, allowing the bolt to ease forward.		
f. Placed the safety on "S" (SAFE).		

**Evaluation Guidance:** Score the soldier GO if all performance measures are passed. Score the soldier NO GO if any performance measure is failed.



If the soldier scores NO GO, show him what was done wrong and how to do it correctly.

#### References

**Required**

FM 3-22.68

**Related**

---

### 071-312-3031

#### Engage Targets with an M60 Machine Gun

**Conditions:** Given a zeroed M60 machine gun with a bipod and linked 7.62-mm ammunition. You have engageable targets in your assigned sector of fire.

**Standards:** Fired the M60 machine gun to engage targets in your assigned sector of fire. Applied correct M60 machine gun target engagement techniques so each target was hit.

---

#### Performance Steps

1. Assume a stable, prone firing position.
2. Align the sights on the target to get a correct sight picture.
  - a. Obtain sight alignment by centering the front sight blade in the aperture of the rear sight with the top of the front sight blade even with the top of the rear sight slide (figure 071-312-3031-1).

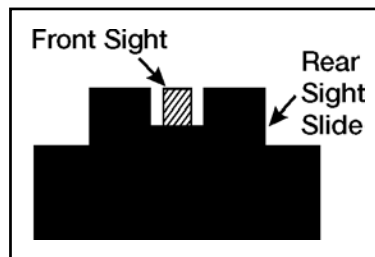


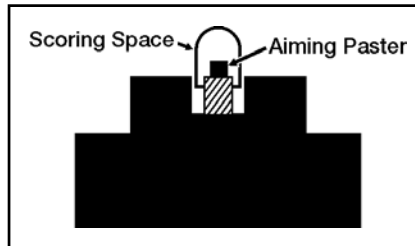
Figure 071-312-3031-1. Sight alignment

- b. Obtain a sight picture by centering the target over the front sight blade so it appears to rest on top of the front sight blade and on top of the rear sight slide (figure 071-312-3031-2).
-

---

**Performance Steps**

---



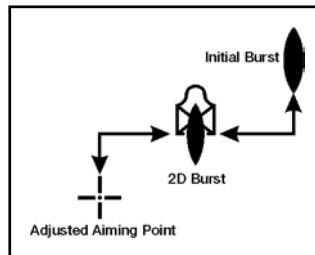
**Figure 071-312-3031-2. Sight picture**

3. Fire the M60 machine gun.
  - a. Pull the trigger straight to the rear.
  - b. Say to yourself "Fire a burst of six."
  - c. Release the trigger.

**Note.** This aids in controlling the number of rounds in each burst and prevents excessive wear on sear and sear notch.

**Note.** If you miss the target with your initial burst, you must select a new aiming point the same distance from the target as the center of impact of the initial burst but in the opposite direction, and fire a second burst.

4. Adjust fire using the adjusted aiming point method (figure 071-312-3031-3).



**Figure 071-312-3031-3. Adjusted aiming point method**

- a. Observe the impact of rounds in the target area by watching the flight of tracer rounds or the strike of rounds in the target area.
- b. Change your body position.

**Note.** Traverse means to move the muzzle of the weapon to the left or right to distribute fire laterally.

---

---

**Performance Steps**

---

c. Traverse the target area with a bipod mounted M60 machine gun by selecting successive aiming points (figure 071-312-3031-4).

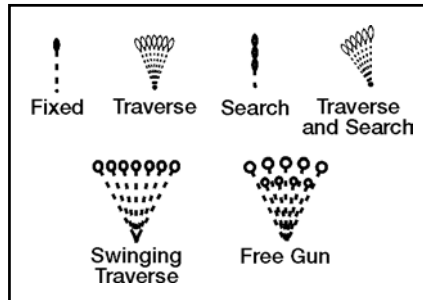


Figure 071-312-3031-4. Traversing and searching

(1) Shift your shoulders slightly to the right or left for minor changes in direction.

(2) Move your elbows and align the body to remain directly behind the gun for major changes.

**Note.** "Search" means to move the muzzle of the weapon up or down to distribute fire in depth across the target area.

d. Search the target area by selecting successive aiming points, changing elevation by moving your elbows closer together or farther apart (figure 071-312-3031-4).

5. Engage an area target using six- to nine-round bursts.

a. Determine the width and depth of the target.

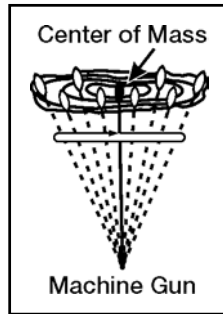
b. Fire six- to nine-round bursts until you hit the center mass of the target area (figure 071-312-3031-5).

---

---

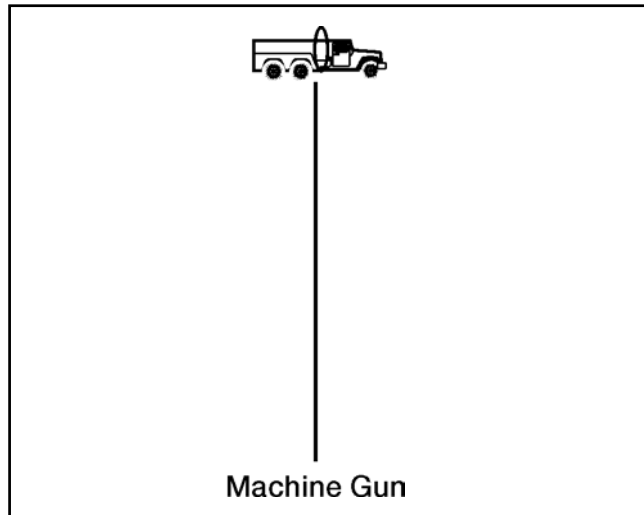
**Performance Steps**

---



**Figure 071-312-3031-5. Center of mass**

- c. Adjust fire by traversing and searching to cover all the target area.
- 6. Engage a point target using six- to nine-round bursts (figure 071-312-3031-6).



**Figure 071-312-3031-6. Point target engagement**

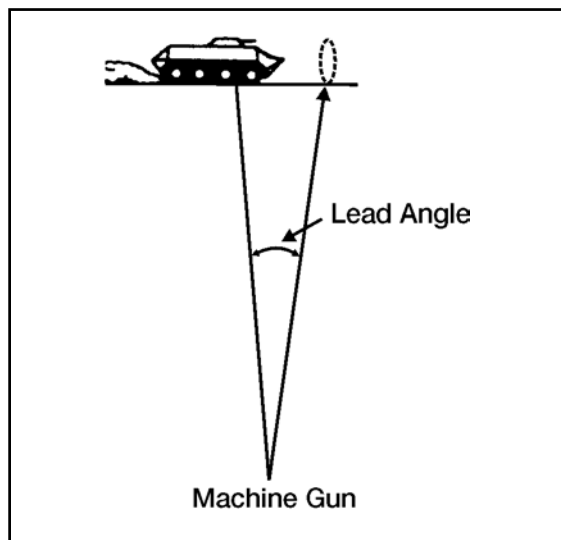
- a. Select a distinct aiming point.
  - b. Estimate range.
-

---

**Performance Steps**

---

- c. Fire six- to nine-round bursts to obtain accurate range and deflection.
  - d. Place effective fire on the target by observing the rounds as they impact in the target area. Make necessary adjustments to hit the target.
7. Engage a moving target using six- to nine-round bursts (figure 071-312-3031-7).



**Figure 071-312-3031-7. Moving target engagement**

- a. Estimate the speed of the target and the lead required to fire and hit it.
- b. Fire, tracking the target as it moves.
- c. Adjust the lead by observing tracers and the strike of the bullets.

---

**Evaluation Preparation:**

*Setup:* Evaluate this task on a live-fire range. Evaluate the soldier on his ability to fire on the center of mass of a target, adjusting his aim by traversing and searching the weapon. Provide the soldier with point targets, area targets, and moving targets. If the soldier hits the target with the first burst, provide the soldier with directions so he demonstrates to you that he can adjust fire. If moving targets are not available, provide the soldier with a scenario in which he must describe the proper technique to use.

*Brief Soldier:* Tell the soldier to assume the prone position. Assign the soldier a sector and direct the soldier to engage area, point, and moving targets and to hit the center of mass of each target. Tell the soldier you are evaluating his ability to adjust fire as much as his ability to hit the target. If a moving target is not available, tell the soldier to simulate firing on a moving target while describing for you the actions required.

Performance Measures	GO	NO GO
1. Assumed a stable, prone firing position.	___	___
2. Aligned the sights on the target to get a correct sight picture.	___	___
a. Obtained sight alignment by centering the front sight blade in the aperture of the rear sight with the top of the front sight blade even with the top of the rear sight slide.		
b. Obtained a sight picture by centering the target over the front sight blade so it appears to rest on top of the front sight blade and on top of the rear sight slide.		
3. Fired the M60.	___	___
a. Pulled the trigger straight to the rear.		
b. Said to yourself "Fire a burst of six."		
c. Released the trigger.		
4. Adjusted fire using the adjusted aiming point method.	___	___
a. Made a minor change in direction.		
b. Made a major change in direction.		
c. Widened the impact area by traversing.		
d. Raised the impact point by searching.		
5. Engaged an area target using six- to nine-round bursts.	___	___
a. Determined the width and depth of the target.		
b. Fired six- to nine-round bursts until you hit the center mass of the target area.		
c. Adjusted fire by traversing and searching to cover all of the target area.		
6. Engaged a point target using six- to nine-round bursts.	___	___
a. Selected a distinct aiming point.		

Performance Measures	GO	NO GO
b. Estimated range.		
c. Fired six- to nine-round bursts to obtain accurate range and deflection.		
d. Placed effective fire on the target by observing the rounds as they impacted in the target area. Made necessary adjustments to hit the target.		
7. Engaged a moving target using six- to nine-round bursts.	—	—
a. Estimated the speed of the target and the lead required to fire and hit it.		
b. Fired, tracking the target as it moved.		
c. Adjusted the lead by observing tracers and the strike of the bullets.		

**Evaluation Guidance:** Score the soldier GO if all performance measures are passed. Score the soldier NO GO if any performance measure is failed. If the soldier scores NO GO, show him what was done wrong and how to do it correctly.

#### References

##### Required

FM 3-22.68

##### Related

### SUBJECT AREA 13: MK19 MACHINE GUN

#### 071-030-0001

##### Maintain an MK19 Machine Gun

**Conditions:** Given an MK19 machine gun, an M3 tripod, a traversing and elevating (T&E) mechanism, an M64 cradle mount; rifle bore cleaner (RBC), lubricant oil (LSA), or lubricating oil (LSAT or LAW); grease (GMD); cleaning solvent (PD680); wiping rags or cloth (abrasive crocus); a cleaning rod assembly and a small-arms cleaning brush; linked 40-mm ammunition and one spent 40-mm cartridge case.

**Standards:** Cleaned and lubricated the MK 19 and its components. Inspected all parts and turned in those in need of maintenance. Reassembled the gun so it was operational. Cleaned and inspected ammunition for serviceability, and turned in any unserviceable ammunition.

071-030-0001

3-407

---

**Performance Steps**

---

1. Clear the MK19.
  - a. Place the safe/fire switch in the SAFE (S) position. Ensure the bolt is forward.
  - b. Open the top cover and inspect the feed tray and extractors on the bolt face to ensure that no round is in the pickup position.
  - c. Unlock and pull charger handle 2 to 3 inches to the rear; inspect the face of the bolt and the chamber for ammunition.
  - d. Return the bolt to the forward position and rotate the charger handle to the locked position.
2. Disassemble the MK19.
  - a. Remove the feed throat assembly (figure 071-030-0001-1). Squeeze the two sets of grip pins together and pull them straight out.
  - b. Remove the bolt and backplate assembly.

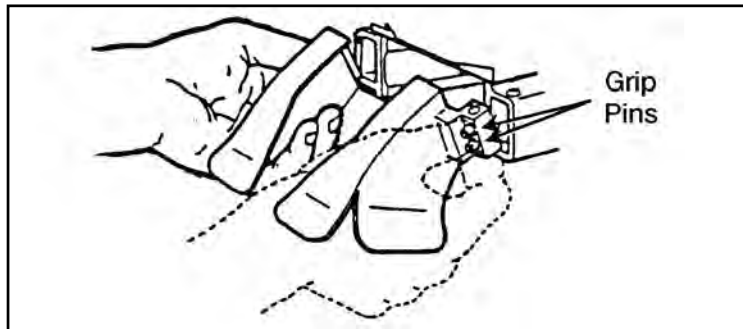


Figure 071-030-0001-1. Removal of feed throat assembly

**WARNING**

Make sure the bolt is in the forward position before you remove the backplate pin assembly. Failure to observe this warning will result in injury.

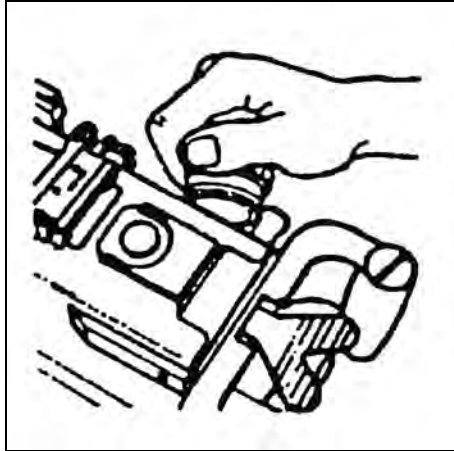
- (1) Place the safe/fire switch on FIRE (F).
  - (2) Open the top cover.
  - (3) Using the rim of a spent cartridge, pull the backplate pin straight out (figure 071-030-0001-2).
-



---

**Performance Steps**

---



**Figure 071-030-0001-2. Removal of backplate pin**

**(4)** Lift up slightly on the backplate assembly. Slowly pull the bolt and backplate assembly out of the receiver.

**(5)** Support the bolt with one hand and maintain a control grip with the other hand. Lift the bolt up slightly and remove it (figure 071-030-0001-3).

---

---

Performance Steps

---

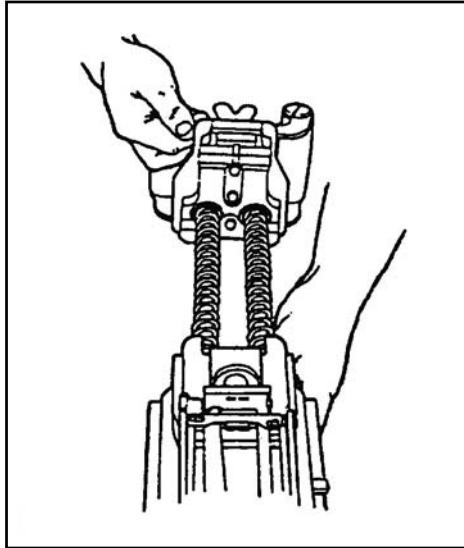


Figure 071-030-0001-3. Removal of bolt and backplate assembly

c. Remove the primary drive lever and vertical cam assembly.

**CAUTION**

Do not rest the vertical cam assembly on its chromed surface.

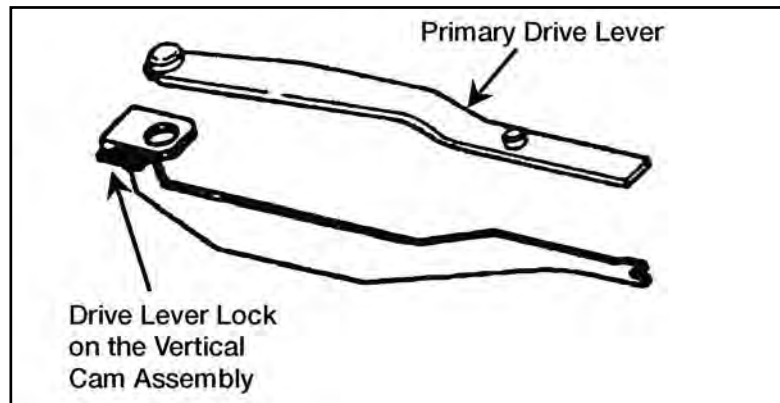
(1) Reach under the top of the receiver to locate the drive lever lock on the vertical cam assembly and slide the lock rearward about 1/4 inch (figure 071-030-0001-4).

---

---

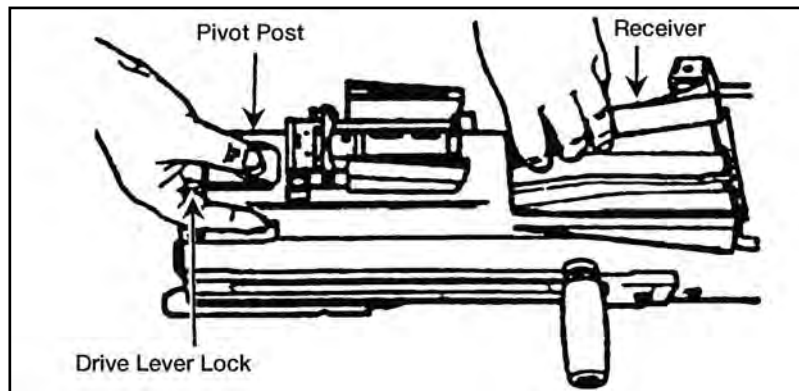
**Performance Steps**

---



**Figure 071-030-0001-4. Primary drive lever and vertical cam assembly**

(2) Press down on the primary drive lever's pivot post. This releases the primary drive lever and vertical cam assembly (figure 071-030-0001-5).



**Figure 071-030-0001-5. Removal of the primary drive lever and vertical cam assembly**

(3) Pull out the cam (to the rear) and the lever from the receiver.  
d. Remove secondary drive lever.

(1) Push down on the pivot post from the outside top cover. This releases the secondary drive lever (figure 071-030-0001-6).

---

---

Performance Steps

---

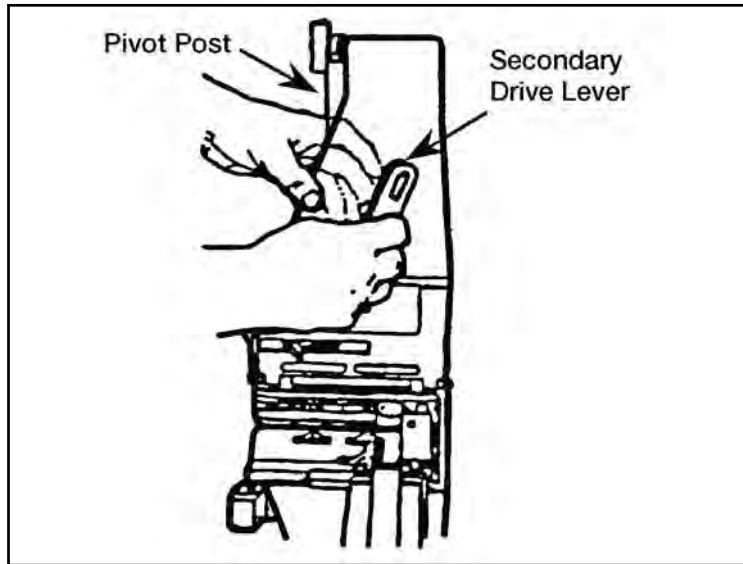


Figure 071-030-0001-6. Removal of the secondary drive lever

(2) Lift out the secondary drive lever from the top cover (figure 071-030-0001-7).

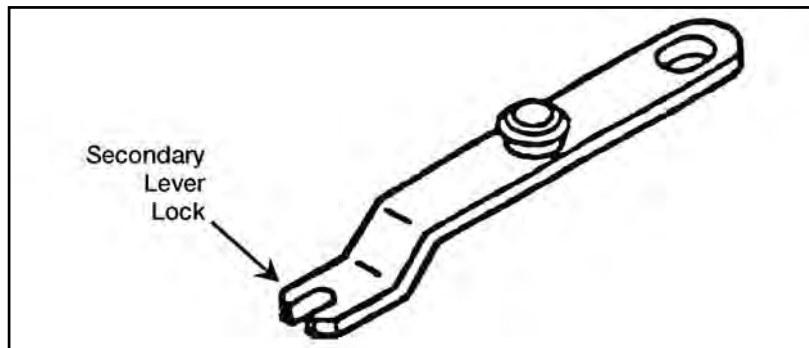


Figure 071-030-0001-7. Secondary drive lever.

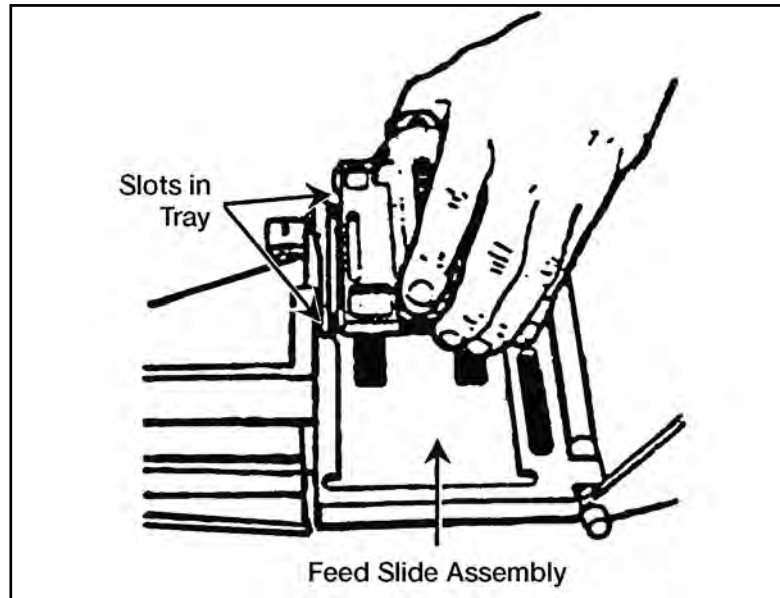
e. Remove the feed slide assembly (Figure 071-030-0001-8).

---

---

**Performance Steps**

---



**Figure 071-030-0001-8. Removal of the feed slide assembly.**

- (1)** Pivot the tray that holds the feed slide assembly out of the top cover.
  - (2)** Move the feed slide assembly to line up the tabs with the slots in the tray.
  - (3)** Lift upward on the feed slide assembly.
- f.** Remove the top cover assembly and feed tray (figure 071-030-0001-9).
-

---

Performance Steps

---

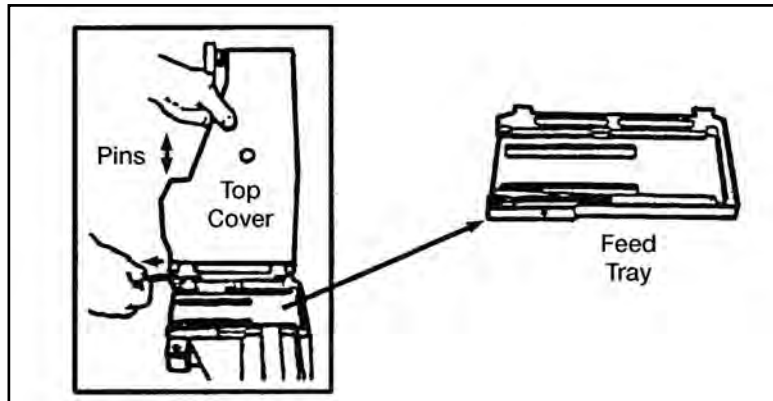


Figure 071-030-0001-9. Removal of the top cover assembly and feed tray

**CAUTION**

Using your fingers only, not pliers, remove the top cover pins. Forcing the pin could break the small cross pin on the rod.

**Note.** The feed tray must be down for you to remove the top cover pins.

- (1) Hold the top cover straight up to align the end of the cross pin.
- (2) Pull straight out on the pins.
- (3) Lift off the top cover.
- (4) Lift the tray out of the feeder.

**g.** Remove the alignment guide assembly (figure 071-030-0001-10).

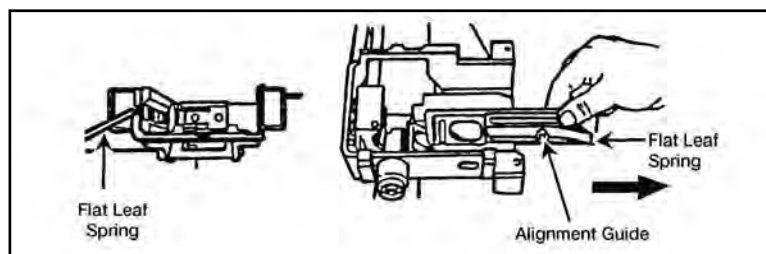


Figure 071-030-0001-10. Removal of the alignment guide assembly

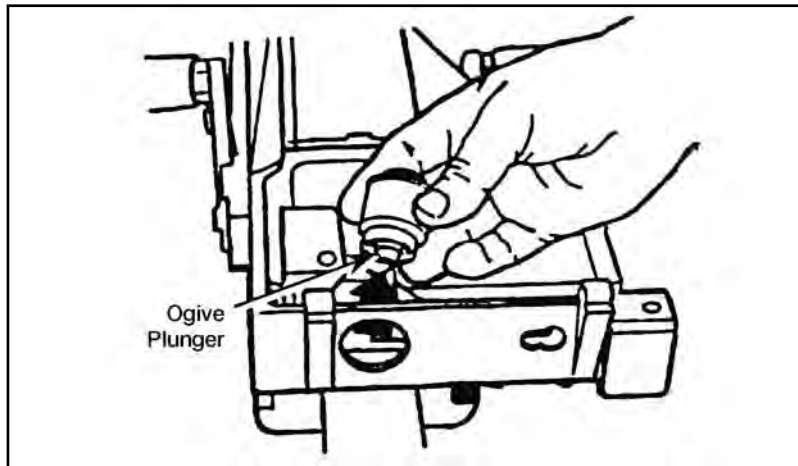
- (1) Depress the flat leaf spring by using a cartridge link toggle (male end) or a small tool.
-

---

**Performance Steps**

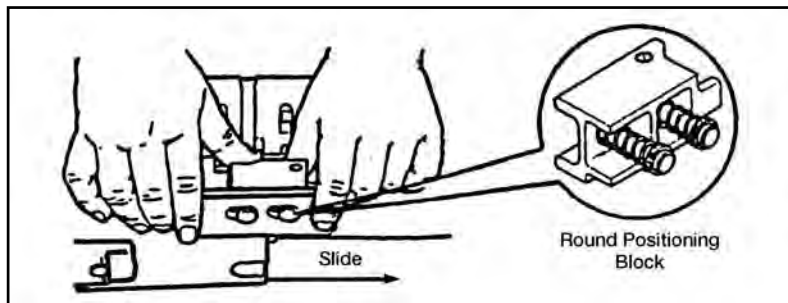
---

- (2) Slide the alignment guide toward the feeder mouth.
- (3) Pull rearward on the alignment guide and lift it out.
- h. Remove the ogive plunger by pulling it out (figure 071-030-0001-11).



**Figure 071-030-0001-11. Removal of the ogive plunger**

- i. Remove the round positioning block (figure 071-030-0001-12).



**Figure 071-030-0001-12. Removal of the round positioning block**

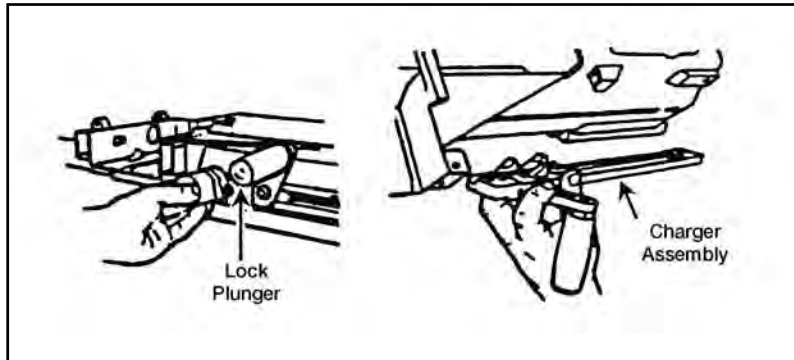
- (1) Grasp the two control grips with both hands and lift up slightly to disengage the backplate from the locking lugs in the receiver.
  - (2) Pull the round positioning block toward the muzzle end of gun.
-

---

**Performance Steps**

---

j. Remove the charger assemblies (both sides) (figure 071-030-0001-13).



**Figure 071-030-0001-13. Removal of the charger assembly**

- (1) Rotate the charger handle up.
- (2) Using either your fingers or a spent case, pry out on the lip of the lock plunger.
- (3) Lift up on the lock plunger to retract it; slide the charger assembly all the way to the rear.
- (4) Pull the charger assembly away from the receiver.

k. Remove the receiver sear assembly (figure 071-030-0001-14).

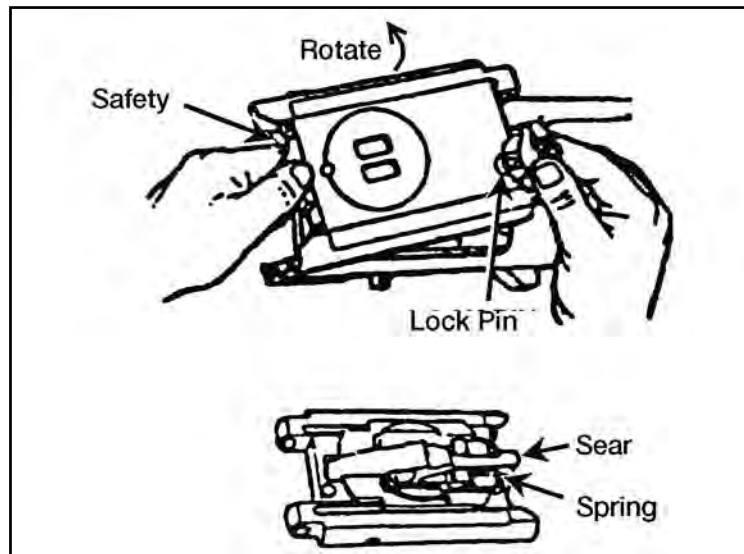
---



---

**Performance Steps**

---



**Figure 071-030-0001-14. Removal of the receiver sear assembly**

(1) Turn the receiver on its top. Put the safe/fire switch in FIRE (F) position.

(2) Lift up slightly on the lock pin with your fingers, using a cartridge link.

(3) Squeeze the receiver sear (underneath the safety) and simultaneously rotate the sear housing assembly approximately 15 degrees in either direction.

(4) Press down on the sear housing assembly and rotate the assembly until it stops (90 degrees from its original position).

(5) Press the receiver sear and safety together while you put safe/fire switch on safe (S). This locks the sear in the down position and keeps you from accidentally losing the sear spring.

(6) Lift out the sear housing assembly.

3. Clean the parts of the MK19.

**Note.** Do not reverse the direction of the bore brush while it is in the bore.

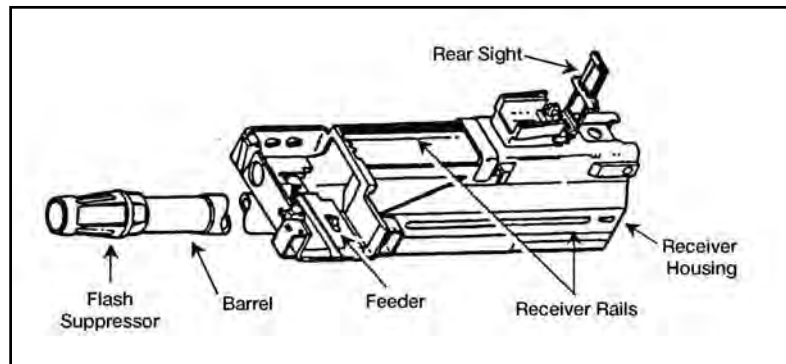
a. Clean the receiver assembly (figure 071-030-0001-15).

---

---

**Performance Steps**

---



**Figure 071-030-0001-15. Receiver assembly**

- (1) Apply solvent to a rag or brush. Wipe or brush dirt away from all parts, especially the interior of the receiver housing, receiver rails, and feeder.
  - (2) Swab out the bore and chamber, using a bore brush and RBC.
  - (3) Wipe all parts dry.
- b. Clean the receiver sear assembly (figure 071-030-0001-14).
- (1) Use only cleaning solvent on a rag or brush.
  - (2) Wipe or brush away dirt.
  - (3) Wipe dry.

**WARNING**

Never immerse the sear housing assembly in solvent. Solvent may dilute the lubricant inside the sear housing.

- c. Clean the alignment guide assembly, ogive plunger, round positioning block, and secondary drive lever; wipe or brush off dirt and dry.

**WARNING**

Never immerse the ogive plunger assembly in solvent.

- d. Clean the charger assemblies.
- (1) Apply cleaning solvent to a rag or brush, and wipe or brush off dirt.
-

---

**Performance Steps**

---

- (2) Wipe dry.
  - e. Clean the vertical cam assembly, primary drive lever, feed slide assembly, and feed tray.
    - (1) Soak in cleaning solvent.
    - (2) Wipe or brush off dirt.
    - (3) Wipe dry.
  - f. Clean the top cover assembly.
    - (1) Apply cleaning solvent to a rag or brush and wipe or brush off dirt from all parts.
    - (2) Wipe all surfaces dry.
  - g. Clean the bolt and backplate assembly.
    - (1) Apply cleaning solvent to rag or brush and wipe or brush off dirt from all parts.
    - (2) Wipe all surfaces dry.
  - 4. Clean the components.
    - a. Clean the T&E mechanism.
      - (1) Remove foreign matter with a clean, dry wiping rag.
      - (2) Use small arms cleaning brush to clean the numbers on the scale.
    - b. Clean the M3 tripod, MK64 gun cradle mount, and pintle.
      - (1) Use a cleaning swab saturated with carbon removing compound to remove dirt.
      - (2) Wipe all parts dry with clean wiping rags.
  - 5. Clean ammunition. Remove foreign matter with a clean, dry wiping rag.
  - 6. Inspect all MK19 parts for serviceability.
    - a. Receiver assembly.
      - (1) Check the receiver housing for cracks and rust.
      - (2) Check the receiver rails for burrs and cracked welds.
      - (3) Check the feeder pawls for burrs and lack of spring action.  
Check the pins for retention.
      - (4) Check the barrel for carbon buildup and pitting in the bore and chamber.
      - (5) Check the flash suppressor for dents, cracks, and erosion.  
Make sure minimal movement is maintained.
-

---

**Performance Steps**

---

- (6) Check the rear sight for rust, binding, and broken or bent parts.
  - b. Receiver sear assembly.
    - (1) Check for burrs on all parts.
    - (2) Closely inspect the rear shoulder for burrs.
  - c. Alignment guide assembly.
    - (1) Check the alignment guide spring for deformity, cracks, and looseness.
    - (2) Check the pin for breaks and cracks.
  - d. Ogive plunger assembly and round positioning block.
    - (1) Check the ogive plunger head for burrs and broken parts.
    - (2) Check the round positioning block for weak spring action and loose or broken parts.
  - e. Charger assembly (left and right).
    - (1) Check the grooved edges for burrs and bends.
    - (2) Check the latches for spring action on detects.
    - (3) Check the entire charger assembly for cracks, burrs, bends, and chips.
  - f. Vertical cam assembly and primary drive lever.
    - (1) Check the vertical cam assembly for bends, burrs, pits, scratches, and aluminum buildup on chromed surface (mirror-like surface).
    - (2) Check the drive lever lock for looseness or binding.
    - (3) Check the primary drive lever for burrs, especially around the pivot posts.
  - g. Secondary drive lever.
    - (1) Check for missing retaining ring from the pivot post.
    - (2) Check the pivot post and forked end for burrs.
  - h. Feed slide assembly and feed tray.
    - (1) Check the feed pawls and feed tray for burrs and binding.
    - (2) Check the guide rails for burrs.
  - i. Top cover assembly.
    - (1) Check the top cover housing for cracks and rust.
    - (2) Check the latch for binding, looseness, and breaks.
  - j. Bolt and backplate assembly.
    - (1) Check the cocking lever for chips, burrs, and breaks.
-

---

**Performance Steps**

---

- (2) Check the guide rods for binding and bends.
  - (3) Check the recoil spring for weak action. Position the bolt end against a hard, flat surface and push up and down on backplate assembly.
  - (4) Check the backplate pin for missing retaining spring.
  - (5) Check for missing, loose or broken safety wire.
  - k. Report any deficiencies to supervisor.
7. Inspect all components for serviceability.
- a. T&E mechanism.
    - (1) Inspect the hand wheels for smooth operation and rust. Check the threads for burrs and rust.
    - (2) Check the traversing slide lock for spring action. Make sure the elevating mechanism sleeve fits on the traversing bar and clamps firmly.
    - (3) Check the traversing and elevating scales for legibility.
    - (4) Inspect the quick release pin and chain for burrs and rust; check for missing spring-loaded balls.
  - b. M3 Tripod.
    - (1) Check for completeness of tripod; make sure all nuts and bolts are tightly secured.
    - (2) Check for cracks on the legs and tripod head.
    - (3) Check for missing, broken, or inoperative lock latch.
    - (4) Check the pintle lock release cam for correct operation.
    - (5) Check the locking action of the front leg clamping assembly.
    - (6) Make sure the rear legs lock in the open position, the sleeve latch notch and the right leg slide notch engage completely, and the latch spring has good tension.
    - (7) Check the telescoping, indexing, and locking actions of rear legs and front leg locking assembly.
  - c. MK64 gun cradle mount.
    - (1) Check for missing or damaged parts.
    - (2) Check for rust, cracks, and burrs.
    - (3) Inspect pintle lock assembly for nut, bolt, and cotter pin. Check the pintle surface for burrs and rust.
  - d. Report any deficiencies to supervisor.
8. Inspect ammunition for damage and corrosion. Turn in any unserviceable ammunition.
-

---

**Performance Steps**

---

**9.** Lubricate the MK19 and components. Do not use CLP, and do not mix lubricants.

**CAUTION**

1. Never immerse the sear housing, ogive plunger, or bolt assemblies in cleaning solvent. Solvent could dilute the lubricant or grease inside.
2. Never lubricate the MK19 with CLP.
3. Avoid mixing lubricants.
4. Completely wipe off all excess lubricants.

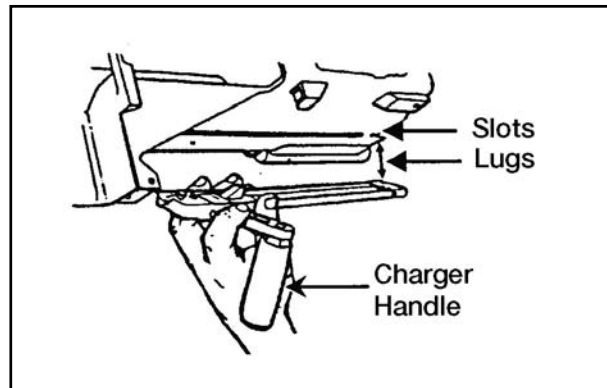
**a.** Lubricate lightly to moderately with LSAT, LSA, or GMD (never CLP). In cold weather (0 to -25 degrees Fahrenheit), use LSAT, LSA, GMD, or LAW. In extra cold weather (-25 degrees Fahrenheit and below), use LAW.

**b.** Apply lubricant to all weapon parts and surfaces except charger handles. Work in the lubricant by moving the parts.

**c.** Lubricate all components and wipe them with an oily rag to remove excess oil.

**10.** Assemble the MK19 machine gun.

**a.** Attach the charger assemblies (both sides) (figure 071-030-0001-16).



**Figure 071-030-0001-16. Attachment of the charger assemblies**

**(1)** Turn the receiver upright.

**(2)** Rotate the charger handles to the straight-up position.

**(3)** Line up the lugs on the charger with the slots in the receiver rail. Insert the charger lugs into the slots.

---

---

**Performance Steps**

---

(4) Hold the charger tightly against the rail. Slide the charger forward until it locks into place.

b. Attach the round positioning block (Figure 071-030-0001-17).

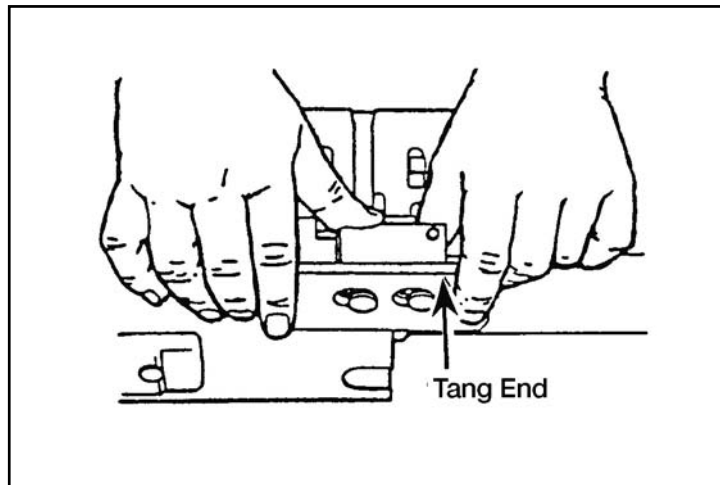


Figure 071-030-0001-17. Attachment of the round positioning block

(1) Insert the blocks into the slots with the tang end forward.

(2) Push against the block and slide it toward the rear until the block locks into place.

c. Insert the ogive plunger assembly into the opening.

d. Insert the alignment guide assembly (figure 071-030-0001-18).

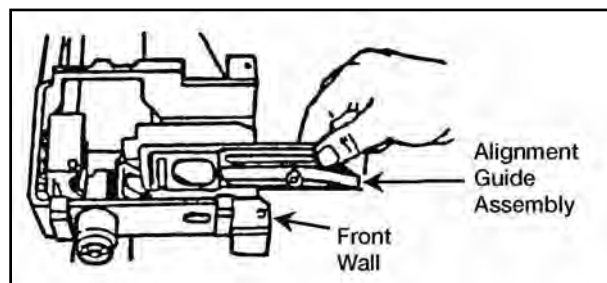


Figure 071-030-0001-18. Insertion of the alignment guide assembly

---

---

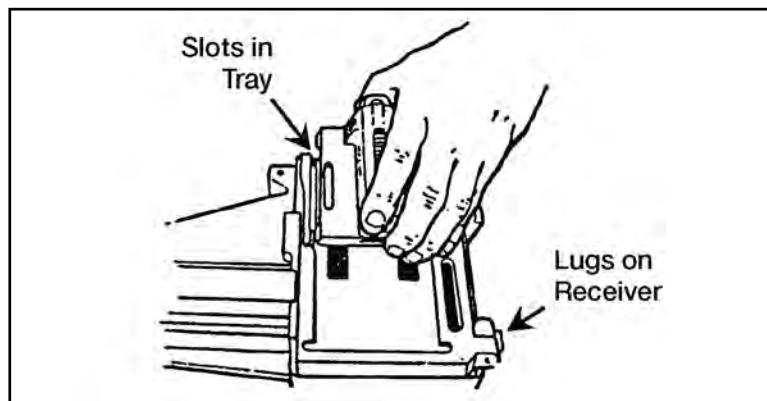
**Performance Steps**

---

(1) Position the alignment guide assembly so the pin is lined up with the slot in the feeder wall.

(2) Hold the alignment guide against the front wall and slide the alignment guide into the receiver until it clicks.

e. Attach the feed tray and feed slide assembly (figure 071-030-0001-19).



**Figure 071-030-0001-19. Attachment of the feed slide assembly**

(1) Place the tray in the top of the feeder, recessed side up.

(2) The pinholes on the tray should line up with the lugs on the receiver.

(3) Position the feed slide assembly by lining up the tabs with the slots on the tray.

(4) Insert the tabs into the slots. Drop the feed slide assembly into the tray and move it slightly to ensure engagement.

f. Attach the top cover assembly (figure 071-030-0001-20).

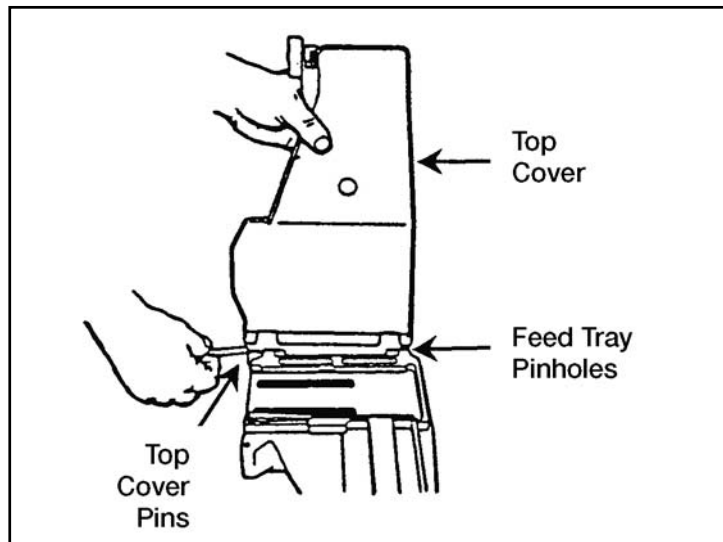
---



---

**Performance Steps**

---



**Figure 071-030-0001-20. Attachment of the top cover assembly**

- (1) Ensure the feed tray is in the proper place in the receiver.
- (2) Place the top cover on the receiver. Line up the pinholes on the cover with the receiver's lug end and the pinholes on the feed tray.
- (3) Hold the top cover straight up. Insert the top cover pins on both sides. Fully insert the cross pin. Rotate the top cover so it is fully open.

**WARNING**

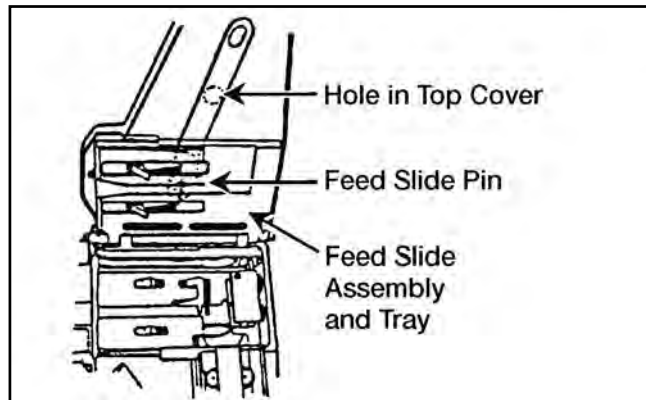
To avoid breaking the cross pin, be sure to insert it fully into the receiver before you close the top cover.

- g.** Engage the secondary drive lever (figure 071-030-0001-21).
-

---

**Performance Steps**

---



**Figure 071-030-0001-21. Engaging the secondary drive lever**

- (1) Rotate the feed slide assembly and tray upward.
- (2) Engage the forked end of the secondary drive lever with the feed slide pin.
- (3) Press the raised pivot post through the hole in the top cover.
- (4) Press the secondary drive lever against the top cover until it locks into place.

**CAUTION**

Be sure to engage the secondary drive lever with the feed slide pin, or the gun will not fire.

**h.** Engage the vertical cam assembly (figure 071-030-0001-22).

---

---

Performance Steps

---

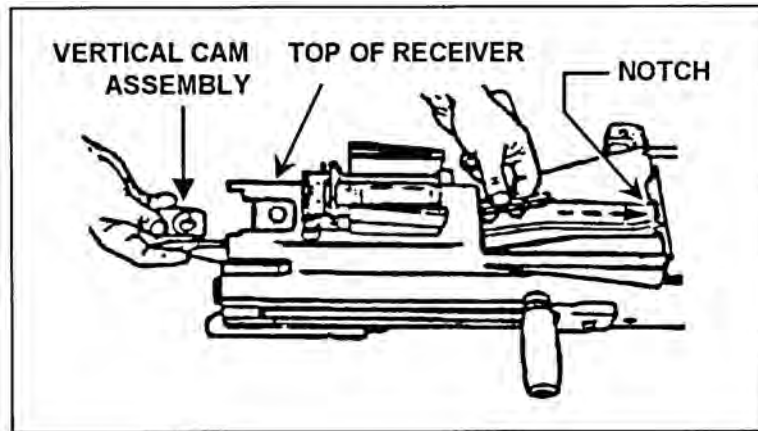


Figure 071-030-0001-22. Engaging the vertical cam assembly.

(1) Slide the vertical cam assembly through the rear of the receiver. The raised portion should slide over the top of the receiver. The drive lever lock should be underneath.

(2) Engage the forked end in the notch.

i. Engage the primary lever (figure 071-030-0001-23).

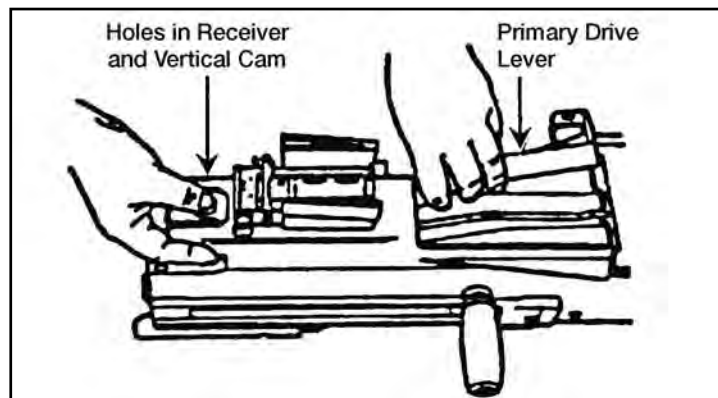


Figure 071-030-0001-23. Engaging the primary drive lever

(1) Hold the vertical cam assembly in place and slide the primary drive lever into the receiver.

---

---

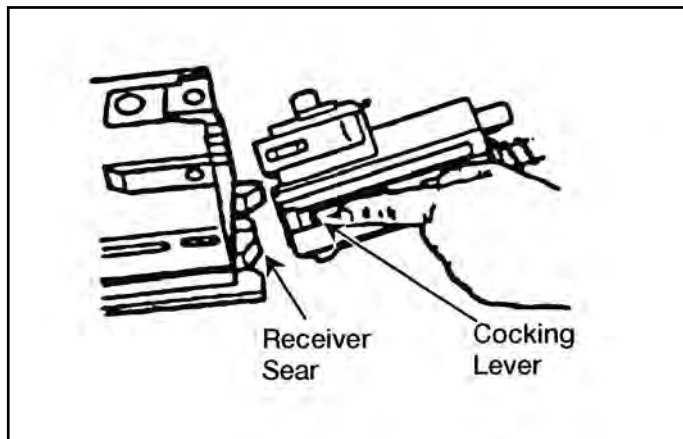
**Performance Steps**

---

(2) Slide the primary drive lever lock to the rear and engage the pivot post lever through the holes in the receiver and vertical cam.

(3) Slide the primary drive lever lock forward. (The primary drive lever lock is located on the vertical cam just beneath the top of the receiver).

j. Insert the bolt and backplate assembly (figure 071-030-0001-24).



**Figure 071-030-0001-24. Insertion of the bolt and backplate assembly**

- (1) Place the safe/fire switch in the fire (F) position.
  - (2) Press the receiver sear using your thumbs or the rim of a cartridge case.
  - (3) Make sure the cocking lever is cocked and forward.
  - (4) Slide the bolt and backplate assembly all the way forward.
  - (5) Insert the backplate pin to lock the assembly in place.
  - (6) Close the cover.
-

---

**Performance Steps**

---

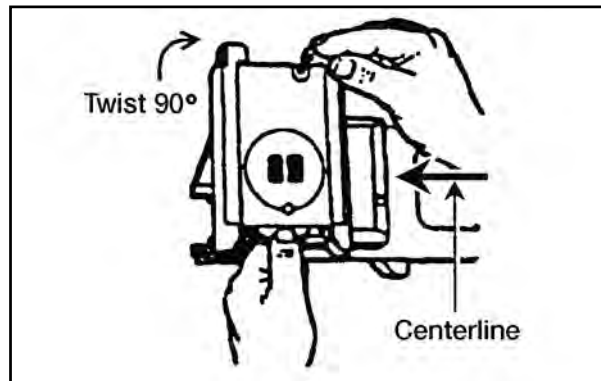
**WARNING**

Before inserting the bolt and backplate assembly, put the cocking lever in the forward position.

**CAUTION**

Before closing the top cover, always make sure the secondary drive lever engages the feed slide pin, the feed slide assembly is to the left, and the bolt is forward. Never try to force the top cover closed. Doing so could damage the weapon.

- k. Attach the receiver sear assembly (figure 071-030-0001-25).



**Figure 071-030-0001-25. Attachment of the receiver sear assembly**

- (1) Turn the receiver over on its top.
  - (2) Place the sear housing on the receiver and line up the sear housing assembly at a right angle to the barrel center line.
  - (3) Put the safe/fire switch on fire (F) position.
  - (4) Press down and rotate the housing assembly until it stops.
  - (5) Press up on the sear and rotate it until it locks in position.
- I. Attach the feed throat assembly.
- (1) Squeeze the grip pins and align them with the holes in the receiver.
  - (2) Release the grip pins to attach the feed throat.
11. Perform a function check to make sure you have assembled the weapon correctly.
-

**Evaluation Preparation:**

*Setup:* At the test site, provide the soldier with the equipment listed in the task conditions. Use the performance steps in the training outline to evaluate the soldier's performance of the task.

*Brief Soldier:* Tell the soldier to perform operator level maintenance on the MK19 and to perform a function check to ensure the weapon functions correctly.

Performance Measures	GO	NO GO
1. Cleared the weapon.	___	___
2. Disassembled the weapon without damaging any parts.	___	___
3. Cleaned the weapon parts.	___	___
4. Cleaned the components.	___	___
5. Cleaned the ammunition.	___	___
6. Inspected all parts, components, and ammunition for serviceability.	___	___
7. Reported all deficiencies to your supervisor.	___	___
8. Lubricated the weapon parts and components using the correct lubricant and lubrication techniques.	___	___
9. Assembled the weapon in the correct sequence without damaging any parts.	___	___
10. Performed a function check.	___	___

**Evaluation Guidance:** Score the soldier GO if all performance measures are passed. Score the soldier NO GO if any performance measure is failed. If the soldier scores NO GO, show him what was done wrong and how to do it correctly.

**References**

**Required**

**Related**

FM 23-27

TM 9-1010-230-10

---

## 071-030-0004

### Engage Targets with an MK19 Machine Gun

**Conditions:** Given a zeroed MK19 machine gun (tripod or cupola mounted), linked 40-mm grenade ammunition, and a sector of fire with engageable targets.

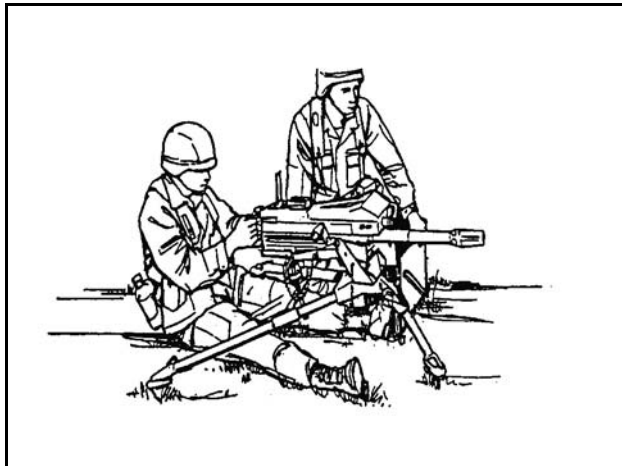
**Standards:** Fired the MK19 machine gun to engage targets in assigned sector of fire. Applied correct machine gun target engagement techniques so each target was covered with fire.

---

#### Performance Steps

---

1. Assume a suitable firing position. Based on your situation, select a firing position that will allow you to observe and engage targets yet minimize your exposure to enemy fire.
  - a. Seated firing positions. Sit directly behind the weapon between the trail legs of the tripod.
    - (1) Legs extended. Extend your legs under the tripod (figure 071-030-0004-1).



**Figure 071-030-0004-1. Seated firing position, legs extended**

- (2) Legs crossed. Cross your legs and place your elbows on the inside of your thighs for support when firing the weapon (figure 071-030-0004-2).
-

---

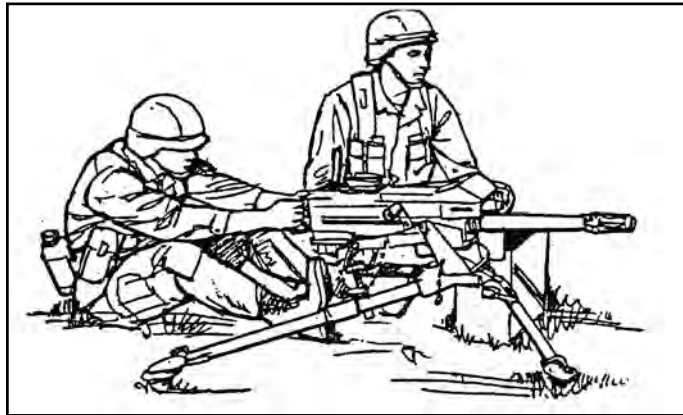
**Performance Steps**

---



**Figure 071-030-0004-2. Seated firing position, legs crossed**

**(3) Legs braced.** Extend your legs, brace them on the trail legs of the tripod, and place your elbows on the inside of your thighs for support (figure 071-030-0004-3).



**Figure 071-030-0004-3. Seated firing position, legs braced**

**b. Kneeling position.** Kneel and grasp the control grips with your thumbs on the trigger (figure 071-030-0004-4).

---



---

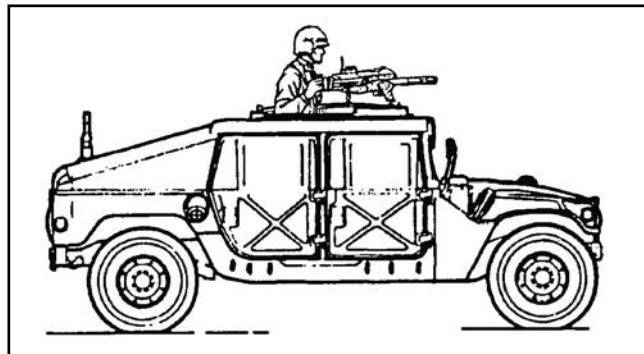
**Performance Steps**

---



**Figure 071-030-0004-4. Kneeling position**

c. Standing position for gun mounted on a vehicle pedestal (figure 071-030-0004-5).



**Figure 071-030-0004-5. Standing position for mounted gun**

2. Acquire the target using correct sight alignment.
  3. Apply correct engagement technique based on target types.
    - a. Use correct gun manipulation technique (figure 071-030-0004-6).
      - (1) Fixed fire. This is fire delivered against a point target. Only one aiming point is necessary with little or no manipulation of the gun.
-

---

**Performance Steps**

---

(2) Traversing fire. This is fire distributed against a wide target requiring successive changes in direction of gun. This means using the T&E mechanism to traverse the gun left or right to distribute fire laterally.

(3) Searching fire. This is fire delivered against a deep target or a linear target with depth in width by successive changes in elevation. This means using the T&E mechanism to move the muzzle of the weapon up or down to distribute fire in depth.

(4) Traversing and searching fire. This is fire delivered in width and depth by successive changes in direction and elevation. It is employed against a target whose long axis is oblique to the direction of fire.

(5) Swinging traverse. This is fire delivered against targets that require major changes in direction but little or no change in elevation. Loosen the traversing slide lock enough to swing the gun laterally.

(6) Free gun. This is fire delivered against moving targets that must be rapidly engaged with fast changes in direction and elevation. To fire free gun, remove the T&E mechanism.

---

---

Performance Steps

---

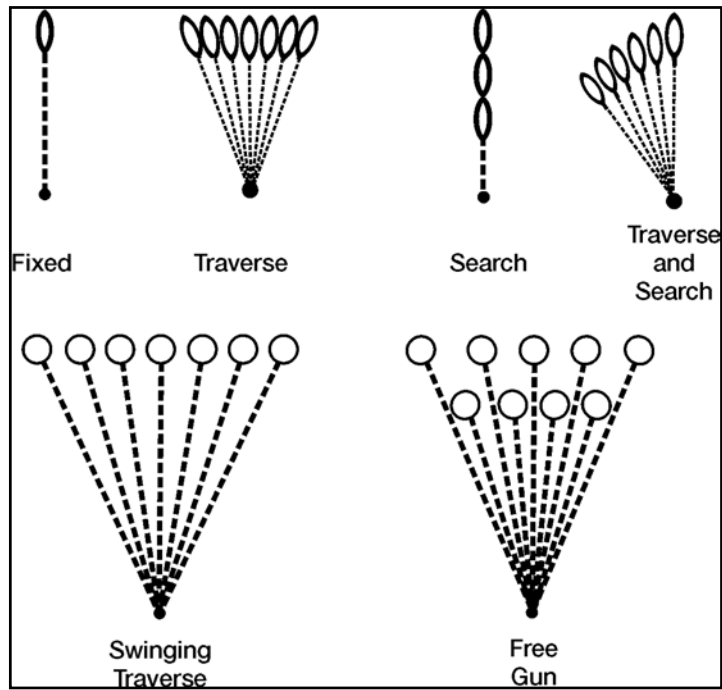


Figure 071-030-0004-6. Techniques of fire with respect to the MK19

b. Use correct application of fire to engage specific targets.

(1) Point target. Engage point targets with fixed fire using a single aiming point (figure 071-030-0004-7).

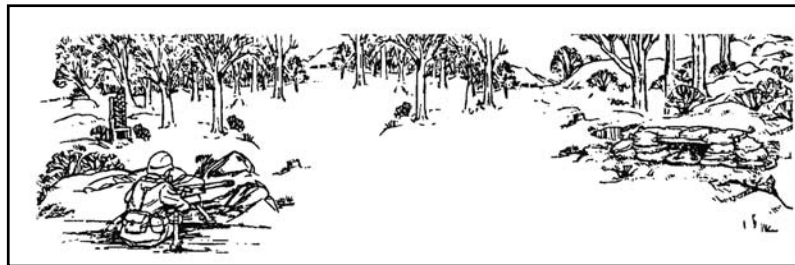


Figure 071-030-0004-7. Point target

---

**Performance Steps**

---

(2) Linear target. Initially aim just outside either flank and fire. Traverse fire back and forth from flank to flank, covering the entire target area (figure 071-030-0004-8).

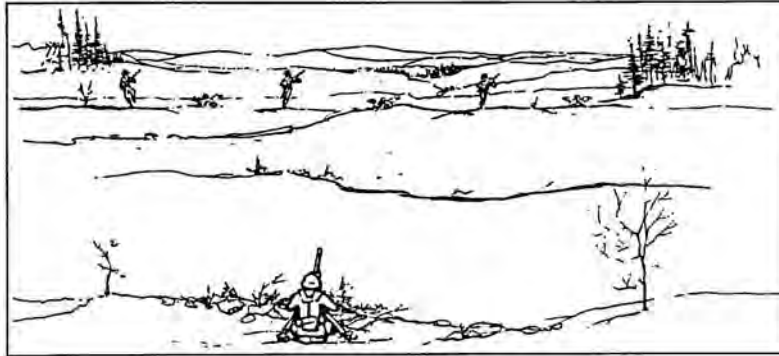


Figure 071-030-0004-8. Linear target

(3) Linear target with depth. Initially aim at the near flank with range set to the midpoint of the target unless another portion of the target is more critical or presents a greater threat. Fire on the near flank, then traverse and search back and forth, covering the entire target (figure 071-030-0004-9).

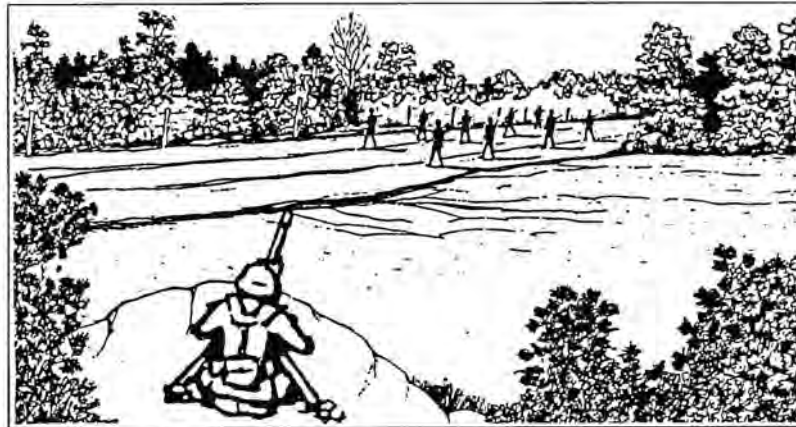


Figure 071-030-0004-9. Linear target with depth

---

---

**Performance Steps**

---

(4) Deep target. Initially aim at the end of the target closest to the gun, unless another portion of the target is more critical or presents a greater threat (auto rifleman). Fire and search up the far end and back again repeatedly (figure 071-030-0004-10).



Figure 071-030-0004-10. Deep target

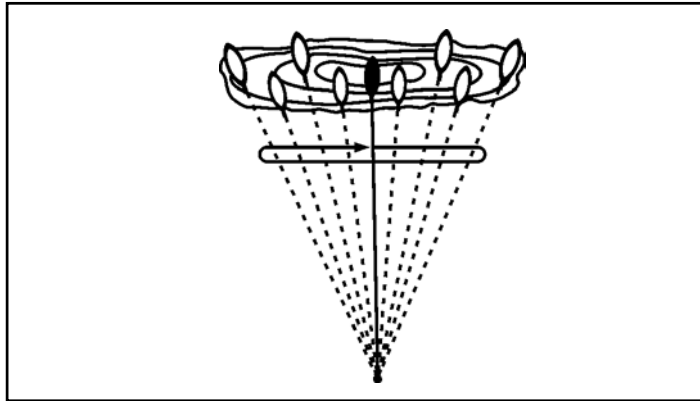
(5) Area target. Initially aim at the midpoint of the target area. Traverse and search to either flank, then traverse and search to the opposite flank (figure 071-030-0004-11).

---

---

**Performance Steps**

---



**Figure 071-030-0004-11. Engagement of area targets, single gun**

**4.** Use observation of fire and adjusted aiming point to place effective fire on the target.

**a.** Observation of fire. Observe the strike of the rounds in relation to the target; adjust elevation and direction needed to move the center of impact onto the target.

**Note.** This does not call for use of the sights.

**Example.** Suppose you fire at a target 500 meters away. The rounds impact 20 meters short and 50 meters right. To manipulate the gun onto the target, use the traversing and elevating mechanism hand wheels to move the muzzle left and up the proper number of clicks.

**b.** Adjusted aiming point. Use this method to adjust fires quickly without making a sight or T&E adjustment (figure 071-030-0004-12).

**(1)** If the initial burst misses the target, rapidly select a new aiming point the same distance from the center of impact of the initial burst but in the opposite direction.

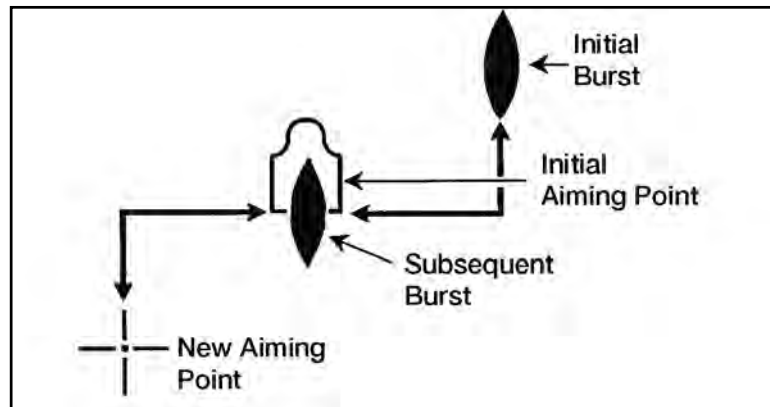
**(2)** Lay the gun on that aiming point and fire.

---

---

**Performance Steps**

---



**Figure 071-030-0004-12. Adjusted aiming point method**

5. Fire on the targets until they are destroyed or until you receive an order to cease fire.
- 

**Evaluation Preparation:**

*Setup:* Evaluate this task on a live-fire range designed for 40-mm machine gun firing. For a tripod mounted MK 19 tell the soldier to fire table II, tasks 4 through 8, FM 23-27, appendix C. For a vehicle-mounted MK19, tell the soldier to fire table III, tasks 2 through 5, FM 23-27, appendix C.

*Brief Soldier:* Tell the soldier to perform the tasks outlined in appendix C, FM 23-27. Brief him on the task conditions, standards, and ammunitions. Tell him he will be evaluated on his ability to apply correct target engagement techniques and place effective fire on targets.

Performance Measures	GO	NO GO
1. Assumed a suitable firing position.	___	___
2. Applied correct engagement technique based on target type.	___	___
a. Used correct gun manipulation technique.		
b. Used correct application of fire to engage specific targets.		
3. Placed effective fire on targets (score a minimum of 84 points).	___	___

Performance Measures	GO	NO GO
4. Used correct application of fire to engage specific targets.	—	—
5. Used observation of fire and adjusted aiming point to place effective fire on the target.	—	—

**Evaluation Guidance:** Score the soldier GO if all performance measures are passed. Score the soldier NO GO if any performance measure is failed. If the soldier scores NO GO, show him what was done wrong and how to do it correctly.

#### References

**Required**

**Related**

FM 23-27

---

## 071-030-0005

### Load an MK19 Machine Gun

**Conditions:** Given a can of linked 40-mm grenade ammunition and a cleared MK19 machine gun mounted on an M3 tripod or on a vehicle. (If firing from a vehicle, ammunition can bracket must be attached to the gun mount.)

**Standards:** Loaded linked ammunition through feed throat into feeder so, when cover was closed, the round was straight and firmly seated against the bolt, and the ammunition fed correctly.

---

#### Performance Steps

1. Make sure the chamber is empty, the bolt is in the forward position, and the charger handles are in the up (lock) position.
2. Make sure the safety switch is in the safe (S) position.

**WARNING**

Do not let the top cover slam shut from the open position. Injury to personnel or damage to equipment could result.

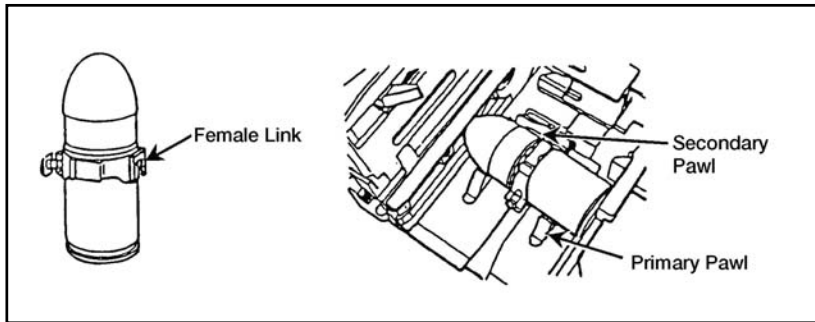
3. Insert the first round.
    - a. Open the top cover and insert the first round through the feed throat into the feeder, link opening first (figure 071-030-0005-1).
-



---

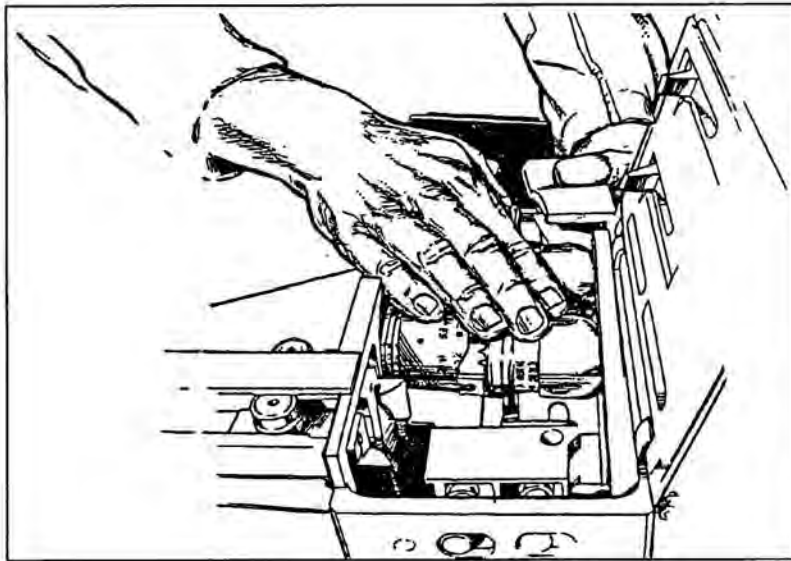
**Performance Steps**

---



**Figure 071-030-0005-1. Insertion of first round through feed throat**

**b.** Push or slide the round across the first set of feeder pawls, making sure the round is straight and firmly seated against the bolt (figure 071-030-0005-2).



**Figure 071-030-0005-2. Pushing round across feeder pawls**

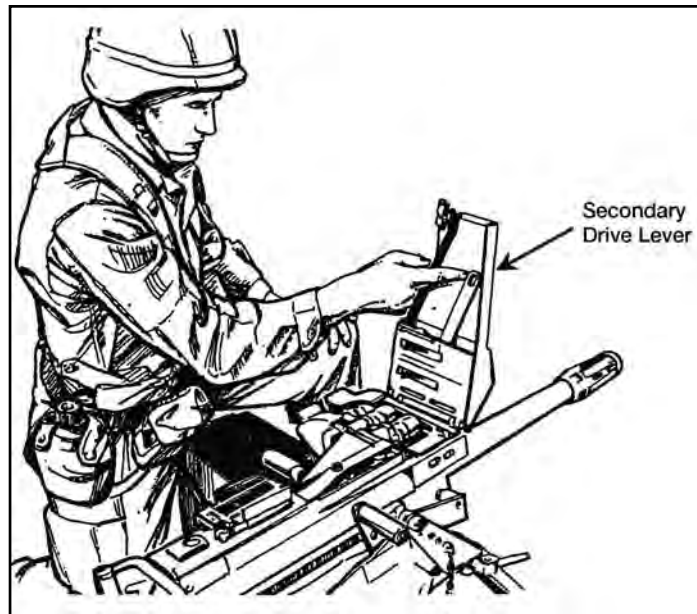
**c.** Index the feed slide assembly to the left and close the top cover (figure 071-030-0005-3).

---

---

**Performance Steps**

---



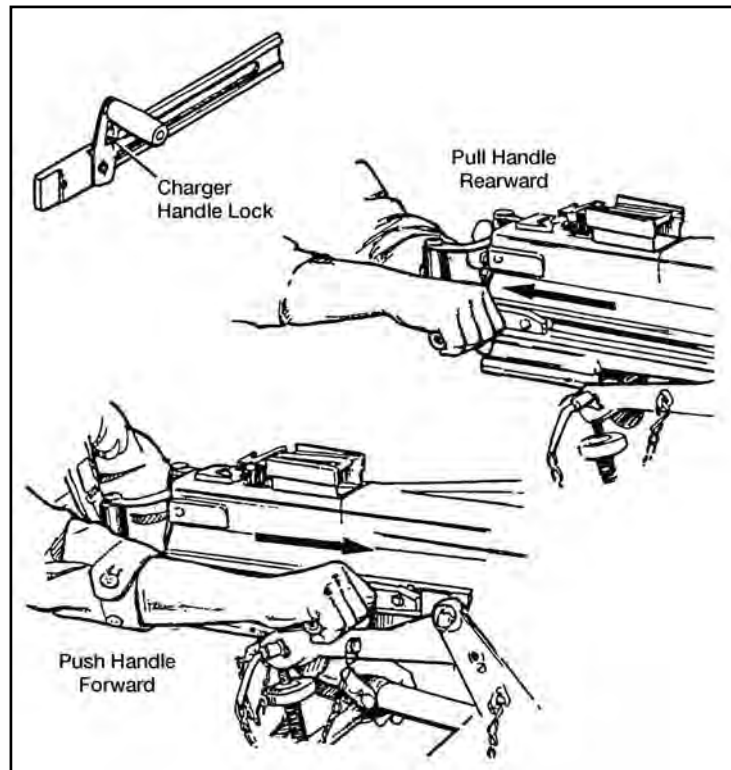
**Figure 071-030-0005-3. Indexing the feed slide assembly**

4. Charge the weapon (figure 071-030-0005-4).
    - a. Grasp charger handles palms down.
    - b. Press charger handle locks and rotate charger handles down.
    - c. Pull charger handles sharply to the rear until the bolt sears.
    - d. Push charger handles forward and rotate them up into the lock position.
-

---

**Performance Steps**

---



**Figure 071-030-0005-4. Charging the MK19 machine gun**

**5. Load the first round.**

- a.** Place safety switch in fire (F) position and press trigger.

**Note.** Bolt will move forward and load the first round on the bolt-face (half load).

- b.** Rotate charger handles down and pull them sharply to the rear until the bolt sears. This pulls the bolt with the loaded round into position for firing (full load).

- c.** Place safety switch in safe (S) position.

- d.** Push the chargers forward and rotate the charger handles up into the lock position. The weapon is fully loaded.

- e.** Leave safety switch on safe (S) position until ready to fire.
-

---

**Performance Steps**

---

**WARNING**

For firing, charger handles must be FORWARD and UP. Keep your weapon pointed downrange and the line of fire clear of objects.

---

**Evaluation Preparation:**

*Setup:* Provide the soldier with the equipment listed in conditions.

*Brief Soldier:* Tell the soldier to load the MK19 according to proper procedures.

Performance Measures	GO	NO GO
1. Made sure the chamber was empty, the bolt was forward, and the charger handles were in the lock position.	___	___
2. Made sure the safety switch was in the safe (S) position.	___	___
3. Inserted the first round.	___	___
a. Opened the top cover and inserted the first round through the feed throat and into the feeder, linked opening first.		
b. Pushed or slid the round across the first set of feeder pawls, made sure the round was straight and firmly seated against the bolt.		
c. Indexed the feed slide assembly to the left and closed the top cover.		
4. Charged the weapon.	___	___
a. Grasped the charger handles palms down.		
b. Pressed the charger handle locks and rotated charger handles down.		
c. Pulled charger handles sharply to the rear until the bolt seared.		
d. Pushed charger handles forward and rotated them up into the lock position.		
5. Loaded the first round.	___	___
a. Placed safety switch on the fire (F) position and pressed the trigger.		

Performance Measures	GO	NO GO
b. Rotated charger handles down and pulled them sharply to the rear until the bolt seared.		
c. Placed safety switch on the safe (S) position.		
d. Pushed charger forward and rotated the charger handles up into the locked position.		
e. Left safety switch in the safe (S) position until ready to fire.		

**Evaluation Guidance:** Score the soldier GO if all performance measures are passed. Score the soldier NO GO if any performance measure is failed. If the soldier scores NO GO, show him what was done wrong and how to do it correctly.

#### References

##### Required

##### Related

FM 23-27

TM 9-1010-230-10

---

## 071-030-0006

### Unload an MK19 Machine Gun

**Conditions:** Given an MK19 machine gun mounted on an M3 tripod or vehicle loaded with linked 40-mm grenade ammunition.

**Standards:** Unloaded the MK19 machine gun, removed ammunition and empty casings. Cleared the weapon, made sure the chamber was empty and the safety switch was in the safe (S) position.

---

#### Performance Steps

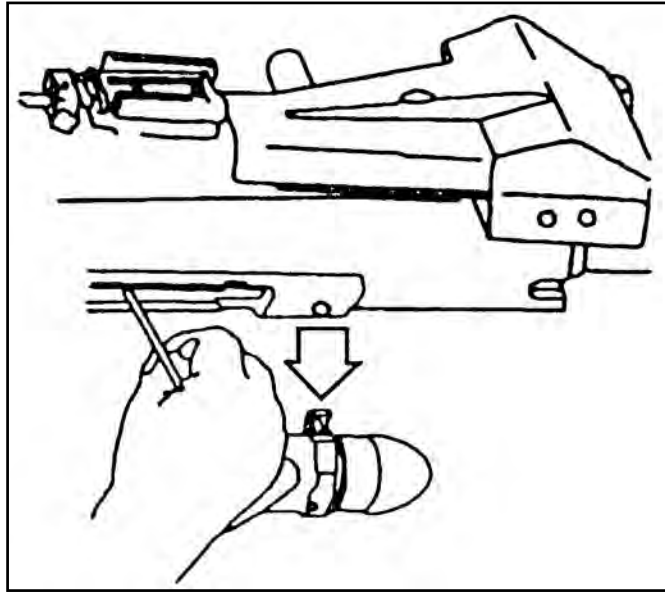
1. Place the safety switch on the safe (S) position.
  2. Charge the weapon.
  3. Return the charger handles to the forward position and rotate only one charger handle up.
  4. Remove the live round or spent case from bolt.
    - a. Insert the tip of a cleaning rod through the right hand rail as close to the bolt face as possible (figure 071-030-0006-1).
-

---

**Performance Steps**

---

b. Lift up on the cleaning rod to force the live round or case off the bolt face and out the bottom of the gun. Catch the live round or the spent case as it falls out.



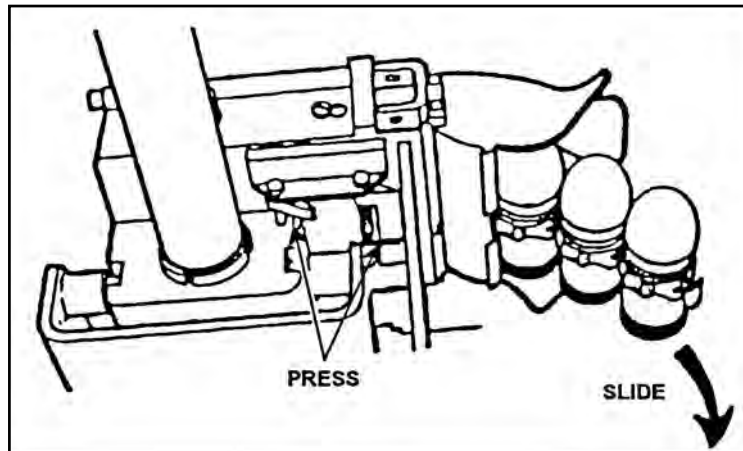
**Figure 071-030-0006-1. Removal of Round or Spent Case**

5. Remove linked rounds from the feeder.
- a. Open the top cover. Check for rounds in the feeder. If you find any rounds in the feeder, perform the following actions (figure 071-030-0006-2).
    - (1) With one hand, reach beneath the feeder. Press the primary and secondary positioning pawls at the same time.
    - (2) At the same time, slide the linked rounds out of the feeder and feed throat.
  - b. Place linked rounds in the ammunition can.
-

---

**Performance Steps**

---



**Figure 071-030-0006-2. Removal of Linked Rounds from the Feeder**

6. Place the safety switch in the fire (F) position.
7. Ride the bolt forward.
  - a. Hold one charger handle to the rear.
  - b. Press the trigger to release the bolt; ride the bolt forward.
  - c. Make sure both charging handles are forward and in the up position.
8. Place the safety switch in the safe (S) position.
9. Index the feed slide assembly to the left.
10. Close and latch the top cover.

---

**Evaluation Preparation:**

*Setup:* Provide the soldier with the equipment listed in the task conditions .

*Brief Soldier:* Tell the soldier to load the MK19 according to the task steps.

Performance Measures	GO	<u>NO GO</u>
1. Placed the safety switch on safe (S) position.	___	___
2. Charged the weapon.	___	___
3. Returned the charger handles to the forward position, and rotated only one charger handle up.	___	___

Performance Measures	GO	NO GO
4. Removed the live round or spent case from bolt.	___	___
a. Inserted the tip of a cleaning rod through the right-hand rail as close to the bolt face as possible.		
b. Raised up on the cleaning rod to force the live round or case off the bolt face and out the bottom of the gun. Caught the live round or the spent case as it fell out.		
5. Removed any linked rounds from the feeder.	___	___
a. Opened the top cover. Checked for rounds in the feeder. If there were rounds in the feeder, performed the following actions:		
(1) With one hand, reached beneath the feeder, and pressed the primary and secondary positioning pawls at the same time.		
(2) At the same time, slid the linked rounds out of the feeder and feed throat.		
b. Placed linked rounds in the ammunition can.		
6. Placed the safety switch on fire (F) position.	___	___
7. Rode the bolt forward.	___	___
a. Held one charger handle to the rear.		
b. Pressed the trigger to release the bolt, and ride the bolt forward.		
c. Made sure both charging handles were forward and in the up position.		
8. Placed the safety switch in the safe (S) position.	___	___
9. Indexed the feed slide assembly to the left.	___	___
10. Closed and latched the top cover.	___	___

**Evaluation Guidance:** Score the soldier GO if all performance measures are passed. Score the soldier NO GO if any performance measure is failed. If the soldier scores NO GO, show him what was done wrong and how to do it correctly.



---

## References

### Required

### Related

FM 23-27

TM 9-1010-230-10

---

## 071-030-0007

### Perform a Function Check on an MK19 Machine Gun

**Conditions:** Given a cleared MK19 machine gun mounted on an M3 tripod or vehicle carrier.

**Standards:** Conducted an operational check of the MK19 machine gun to make sure it was correctly assembled and functioned properly.

---

#### Performance Steps

**WARNING**

Before performing any procedure, make sure the weapon is clear of ammunition.

1. Check the functioning of the safety switch.
    - a. With the cover closed, place safety switch on safe (S).
    - b. Pull the bolt to rear, push charger handles to forward position, and rotate handles up.
    - c. Press the trigger. Bolt should not go forward.
    - d. Place the safety switch on fire (F) position.
    - e. Press the trigger. Bolt should spring forward.
    - f. Place the safety switch on safe (S) and leave the bolt in forward position.
  2. Open top cover assembly and inspect the feed tray assembly and the chamber to ensure the gun is clear.
    - a. Open the top cover.
    - b. Touch the firing pin. If it is not protruding, recharge and release the bolt spring under pressure.
    - c. Inspect the bolt face to make sure it is not worn, dirty, pitted, corroded, or in need of lubrication.
-

---

**Performance Steps**

---

**WARNING**

Do not allow the top cover to slam shut from the raised position. Doing so could injure your hand or damage the equipment.

3. Check the feed slide assembly and feeder.
  - a. Move the secondary drive lever back and forth. The feed slide assembly should move freely.
  - b. Press the feed pawls to check for spring pressure.
  - c. Inspect the link guide for roughness and galling.

**Note.** Before closing the top cover, always make sure that—  
Secondary drive lever is engaged with the feed slide pin.  
Feed slide assembly is to the left.  
Bolt is forward.

**Note.** Never try to force the top cover closed. Doing so could damage the equipment.

- d. Close and latch the top cover.

4. If you find any deficiencies that you cannot correct, the MK19 is unserviceable. Report the deficiencies to your supervisor.
- 

**Evaluation Preparation:**

*Setup:* At the test site, provide the soldier with the equipment listed in task conditions.

*Brief Soldier:* Tell soldier to perform a function check to determine if the MK19 machine gun functions properly.

Performance Measures	GO	NO GO
1. Checked functioning of safety switch.	___	___
2. Inspected interior of receiver assembly for missing or damaged parts.	___	___
3. Checked feed slide assembly and feeder.	___	___
4. Reported deficiencies to supervisor.	___	___

**Evaluation Guidance:** Score the soldier GO if all performance measures are passed. Score the soldier NO GO if any performance measure is failed. If the soldier scores NO GO, show him what was done wrong and how to do it correctly.

**References**

**Required**

**Related**

TM 9-1010-230-10

**SUBJECT AREA 14: CALIBER .50 M2 MACHINE GUN**

---

**071-022-0001**

**Maintain a Caliber .50 M2 Machine Gun**

**Conditions:** Given a caliber .50 M2 HB machine gun, M3 tripod, MK64 gun cradle mount, pintle, traversing and elevating (T&E) mechanism, linked caliber .50 ammunition, headspace and timing gauge, cleaner lubricant and preservative (CLP), rifle bore cleaner (RBC), lubricating oil semifluid (LSA), carbon removing compound, bore brush, wiping rags, M4 cleaning rod, small-arms (2-inch) cleaning swabs, and a wooden block.

**Standards:** Cleaned and lubricated the caliber .50 M2 machine gun and its components. Cleaned and inspected all parts and ammunition and turned in unserviceable parts for maintenance. Assembled the gun so it was operational.

---

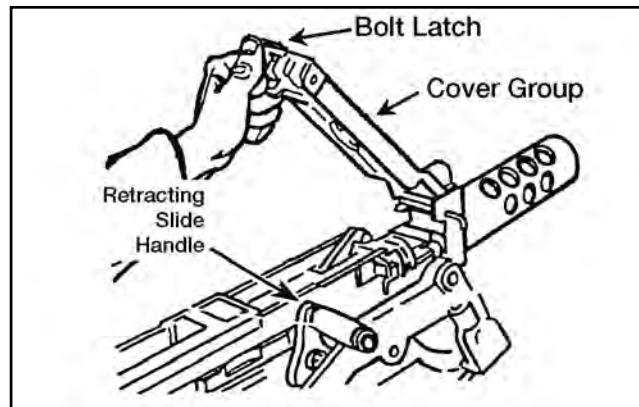
**Performance Steps**

1. Clear the caliber .50 machine gun.
    - a. Unlock the bolt latch release and raise the cover (figure 071-022-0001-1).
    - b. Pull and lock the bolt to the rear, leaving the retracting slide handle to the rear.
    - c. Inspect the chamber and T-slot to make sure they hold no rounds.
    - d. Place a wooden block inside the receiver, between the bolt and the rear of the barrel.
    - e. Insert the cleaning rod in the muzzle end of the barrel until you can see the rod in the receiver. Remove the cleaning rod.
    - f. Grasp the retracting slide handle, press the bolt latch release, and ease the bolt forward. Close the cover.
-

---

**Performance Steps**

---



**Figure 071-022-0001-1. Raising the cover**

2. Disassemble the machine gun.
    - a. Remove the barrel assembly.
      - (1) Raise the cover group (figure 071-022-0001-1).
      - (2) Grasp the retracting slide handle with the right hand, palm up. Pull the bolt to the rear until the barrel locking spring lug aligns with the 3/8-inch hole in the right side plate of the receiver (figure 071-022-0001-2).
      - (3) Place the smallest loop of a caliber .50 link between the trunnion block and the barrel extension (figure 071-022-0001-2). This keeps the barrel locking spring lug aligned with the 3/8-inch hole.
      - (4) Unscrew the barrel from the receiver. Be careful not to damage the threads or barrel locking notches.
      - (5) Remove the caliber .50 link to allow the bolt to go forward slowly. Make sure the bolt group does not slam forward with the barrel removed.
-

---

Performance Steps

---

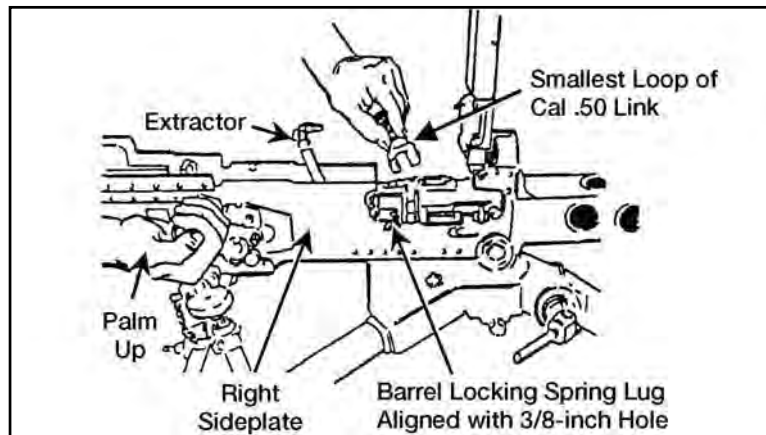


Figure 071-022-0001-2. Alignment of the lug

b. Remove the backplate assembly.

**WARNING**

Do not remove the backplate unless the bolt is in the forward position. When removing the backplate, stand to one side of the weapon to avoid possible injury from the driving spring rod.

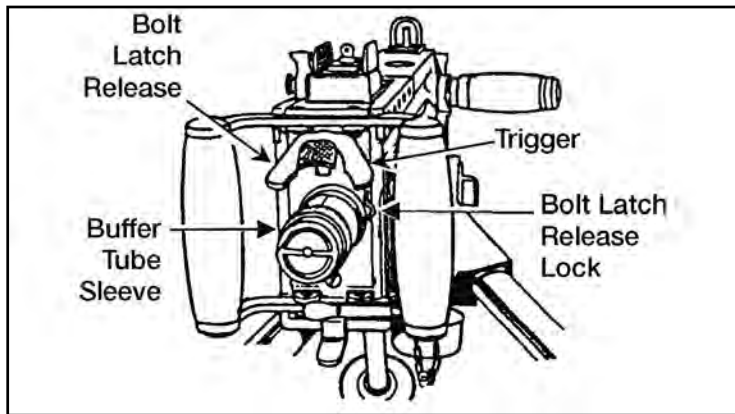
(1) Ensure that the bolt is forward and the bolt latch release is unlocked (in the single shot mode) (figure 071-022-0001-3).

---

---

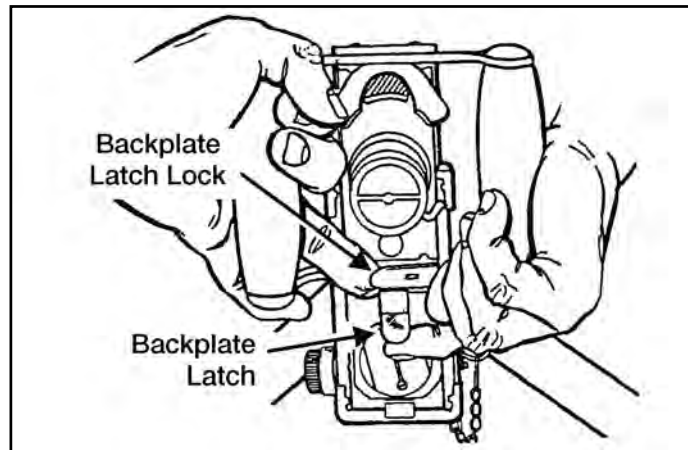
**Performance Steps**

---



**Figure 071-022-0001-3. Releasing the bolt latch**

**(2)** Pull the backplate latch lock straight back while lifting up on the backplate latch (figure 071-022-0001-4).



**Figure 071-022-0001-4. Removal of the backplate**

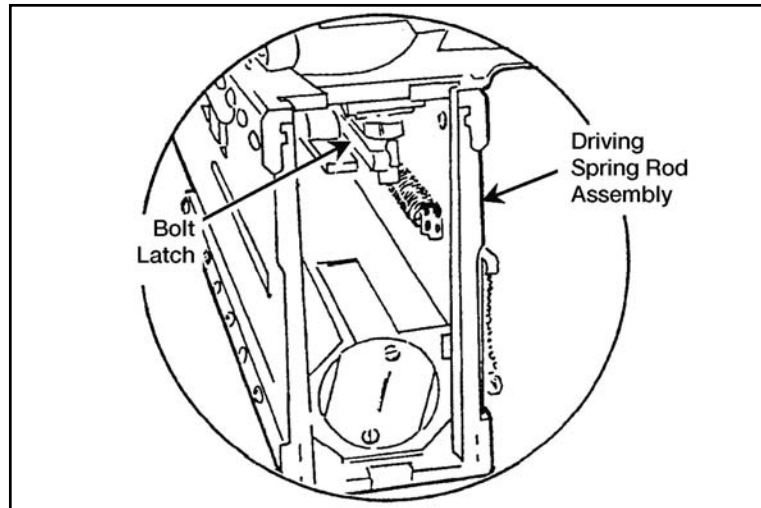
**(3)** Remove the backplate assembly by lifting straight up.  
**c.** Remove the driving spring rod assembly (figure 071-022-0001-5).

---

---

**Performance Steps**

---



**Figure 071-022-0001-5. Removal of the driving spring rod assembly**

(1) Push the rear of the driving rod assembly forward and to the left to free it from the side of the receiver.

**WARNING**

Never try to charge the machine gun while the backplate is off and the driving spring rod assembly is in place. If the backplate is off and the driving spring assembly is compressed, the retaining pin on the driving spring can slip from its seat in the side plate. This could cause serious injury to anyone behind the machine gun.

(2) Pull the driving spring rod assembly to the rear and out of the receiver.

d. Remove the bolt assembly.

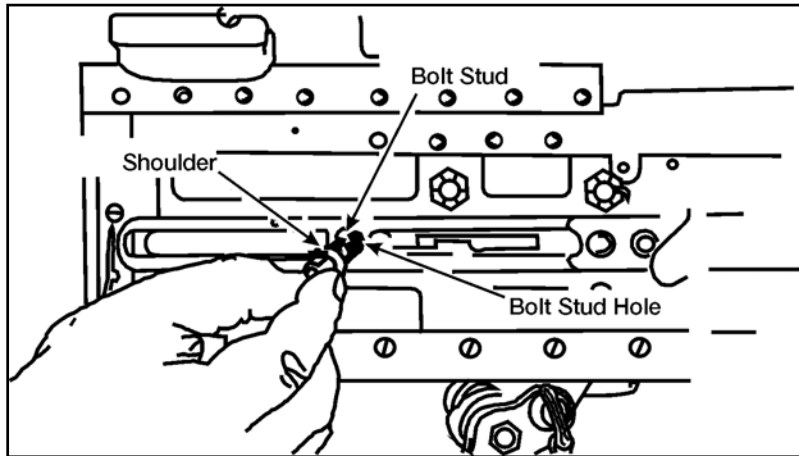
(1) Retract the bolt assembly far enough to the rear to align the bolt stud with the bolt stud hole in the right side plate of the receiver (figure 071-022-0001-6).

---

---

**Performance Steps**

---



**Figure 071-022-0001-6. Removal of the bolt stud**

**(2)** If you accidentally move the bolt all the way to the rear, the bolt latch will engage in the bolt latch notches in the top of the bolt. If this occurs, raise the bolt latch and push the bolt forward to align the bolt stud with the clearance hole (figure 071-022-0001-7).

---



---

Performance Steps

---

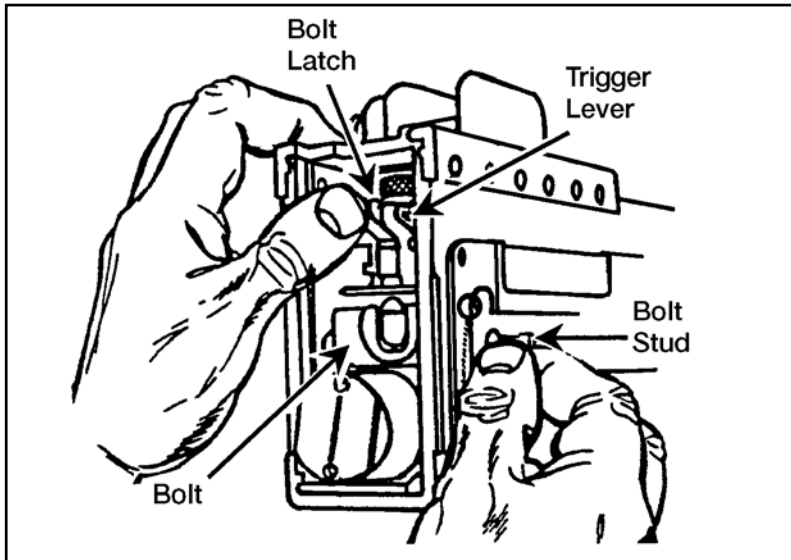


Figure 071-022-0001-7. Unlatching the bolt

- (3) Remove the bolt stud.
  - (4) Remove the bolt assembly by pulling it from the rear of the receiver (figure 071-022-0001-8).
-

---

Performance Steps

---

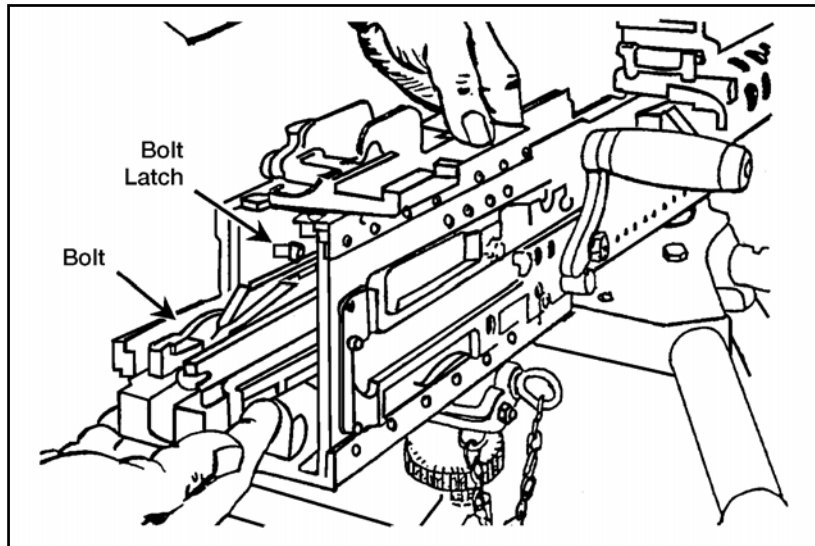


Figure 071-022-0001-8. Removal of the bolt from the receiver

(5) Disassemble the bolt.

(a) Rotate the cartridge extractor upward and remove it from the left side of the bolt (figure 071-022-0001-9).

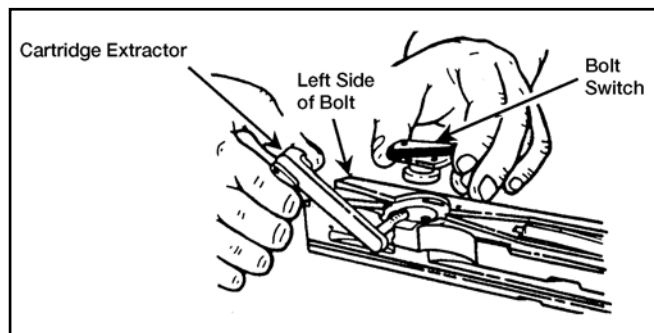


Figure 071-022-0001-9. Removal of the cartridge extractor and bolt

(b) Remove the bolt switch by lifting it straight up.

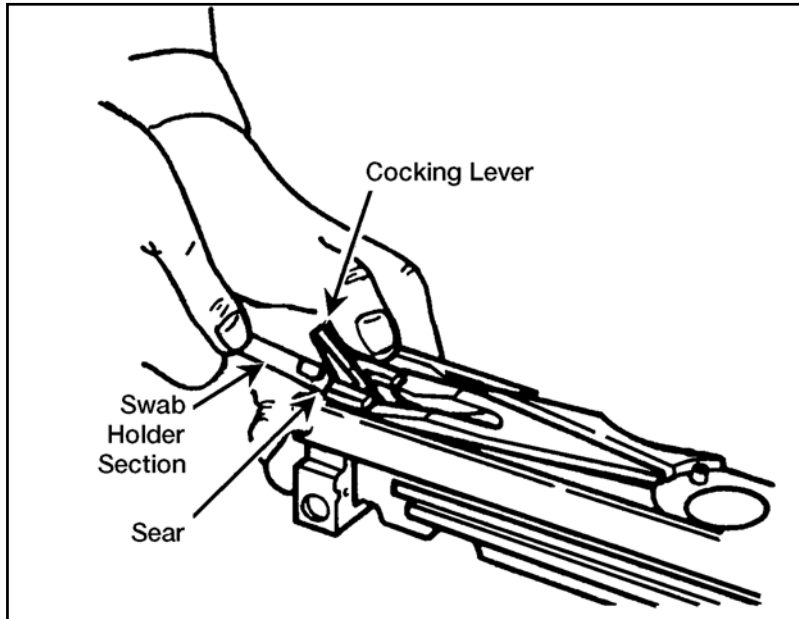
---

---

**Performance Steps**

---

(c) Place the cocking lever in its rearmost position. Press down on the sear with a swab holder and release the firing pin spring (figure 071-022-0001-10).



**Figure 071-022-0001-10. Releasing the firing pin spring**

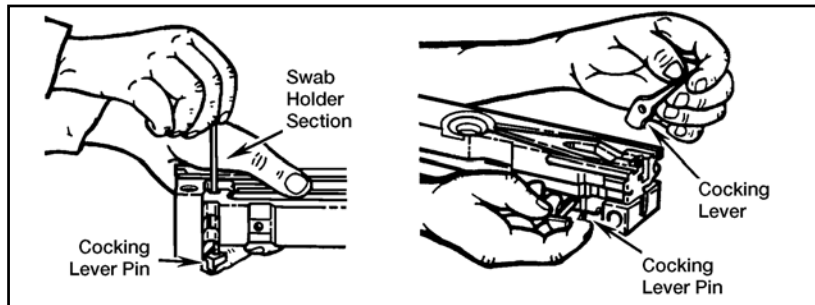
(d) Insert a swab holder section in the hole at the rear of the bolt and push out the cocking lever pin and the cocking lever (figure 071-022-0001-11).

---

---

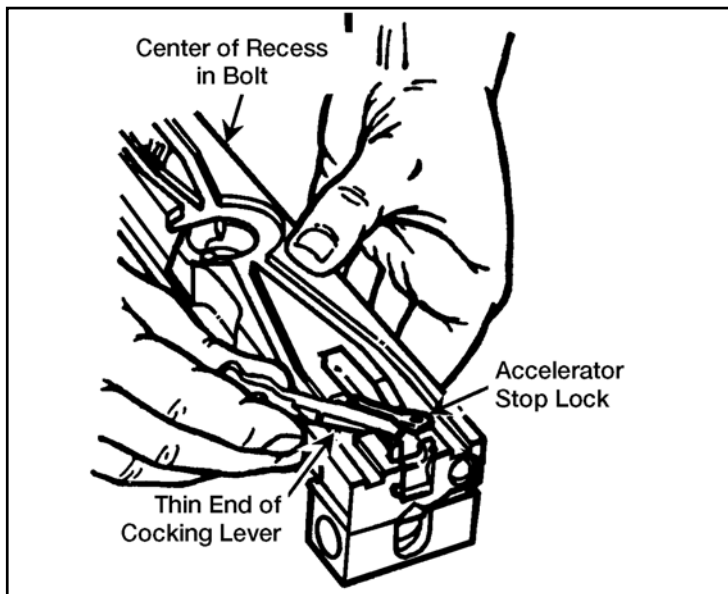
**Performance Steps**

---



**Figure 071-022-0001-11. Removal of the cocking lever pin and cocking lever**

(e) Use the thin end of the cocking lever to rotate the accelerator stop lock to the center of the bolt, then pry up the accelerator stop lock and remove it (figure 071-022-0001-12).



**Figure 071-022-0001-12. Removal of the accelerator stop lock**

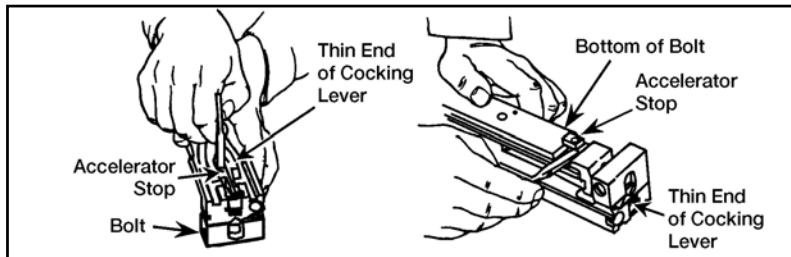
---

---

**Performance Steps**

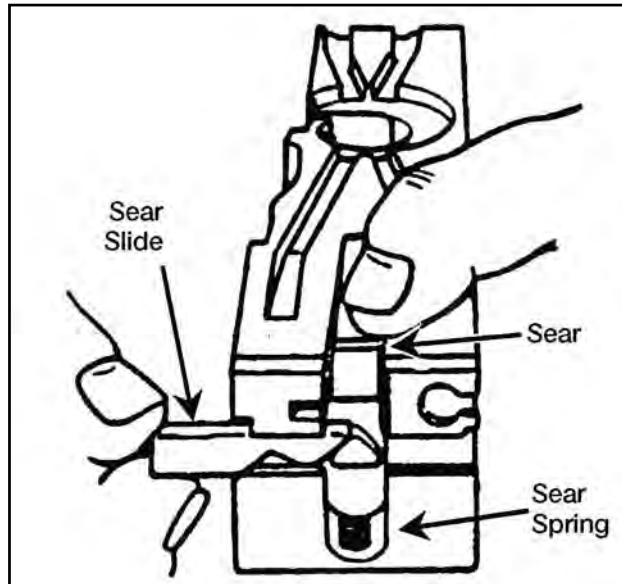
---

(f) Using the thin end of the cocking lever, press the accelerator stop from the bolt, turn the bolt over, and pry the accelerator stop from bottom of bolt (figure 071-022-0001-13).



**Figure 071-022-0001-13. Removal of the accelerator stop**

(g) Depress the sear and remove the sear slide, sear, and sear spring (figure 071-022-0001-14).



**Figure 071-022-0001-14. Removal of the sear slide, sear, and sear spring**

---

---

**Performance Steps**

---

(h) Tip the front end of the bolt upward and remove the firing pin extension assembly (figure 071-022-0001-15).

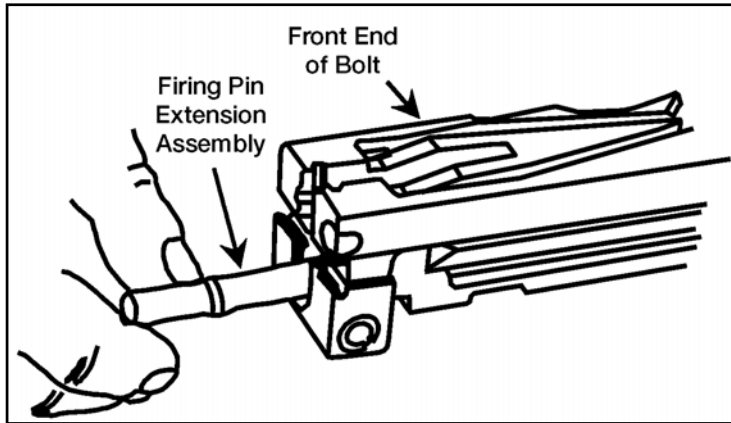


Figure 071-022-0001-15. Removal of the firing pin extension assembly

(i) Remove the firing pin from the firing pin extension assembly.

e. Remove the barrel buffer and barrel extension assemblies (figure 071-022-0001-16).

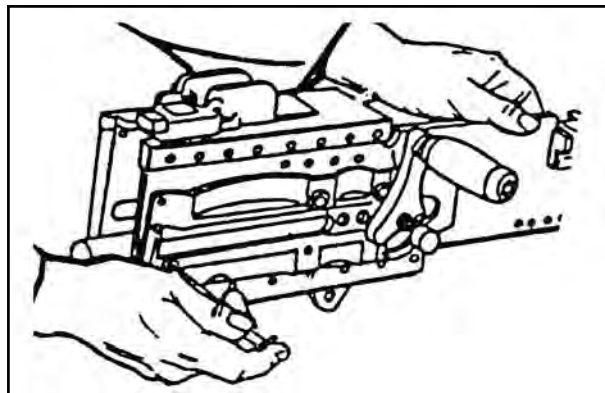


Figure 071-022-0001-16. Removal of the barrel buffer group and barrel extension group

---

---

**Performance Steps**

---

(1) Insert a pointed instrument (you can use the pointed end of the M4 cleaning rod) in the hole at the lower rear corner of the right side plate. Depress the buffer body lock and, at the same time, place one hand inside the receiver and push the barrel extension and buffer assemblies to the rear until the buffer accelerator is near the rear of the receiver body.

**WARNING**

Maintain thumb pressure on the buffer accelerator while removing the barrel buffer and barrel extension assemblies.

(2) Maintain pressure on the buffer accelerator with your thumb and remove the barrel buffer and barrel extension assemblies from the receiver. Separate them by pushing forward on the accelerator tips (figure 071-022-0001-17).

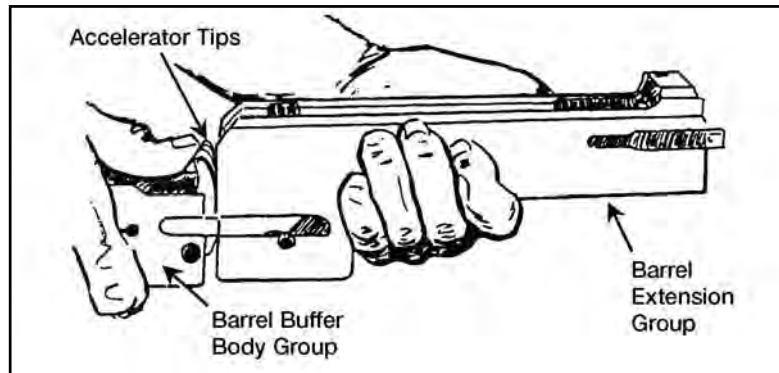


Figure 071-022-0001-17. Separation of the barrel buffer and barrel extension assemblies.

(3) Disassemble the barrel buffer assembly.

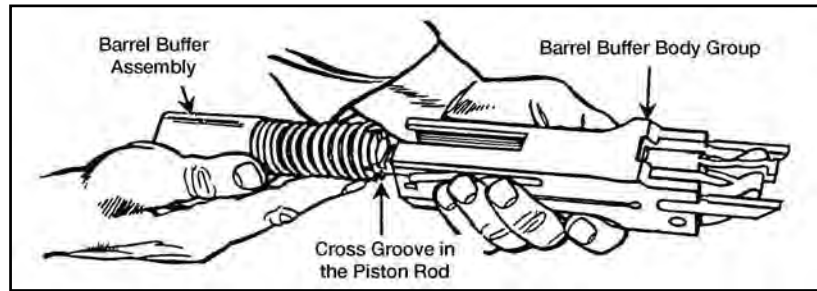
(a) Remove the buffer assembly by pushing it out the rear of the body of the barrel buffer (figure 071-022-0001-18).

---

---

**Performance Steps**

---



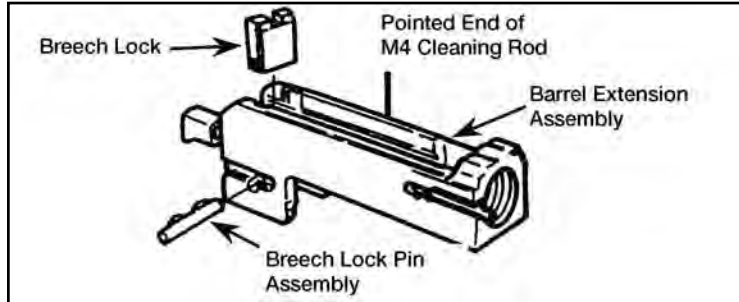
**Figure 071-022-0001-18. Removal of the barrel buffer assembly**

(b) Using a swab holder, drive the accelerator pin assembly from the barrel buffer body group.

(c) Remove the buffer accelerator.

(4) Disassemble barrel extension assembly.

(a) Using the pointed end of the M4 cleaning rod, remove breech lock pin assembly (figure 071-022-0001-19).



**Figure 071-022-0001-19. Removal of the breech lock pin assembly and breech lock**

(b) Remove breech lock.

f. Disassemble receiver assembly.

(1) Remove the front cartridge stop and rear cartridge stop assembly (figure 071-022-0001-20).

---



---

Performance Steps

---

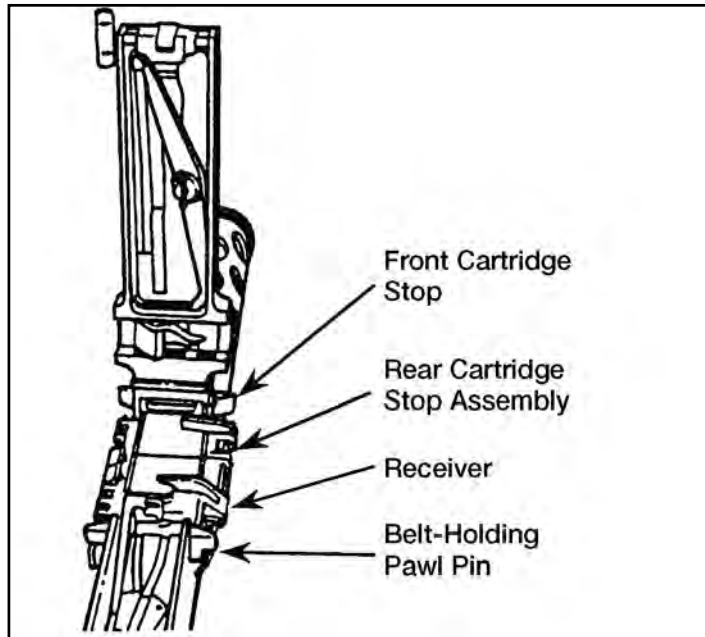


Figure 071-022-0001-20. Removal of the cartridge stop assemblies

(2) Press down on belt holding pawl assembly to prevent loss of springs, and remove the belt holding pawl pin. Remove belt holding pawl assembly and springs (figure 071-022-0001-21).

---

---

Performance Steps

---

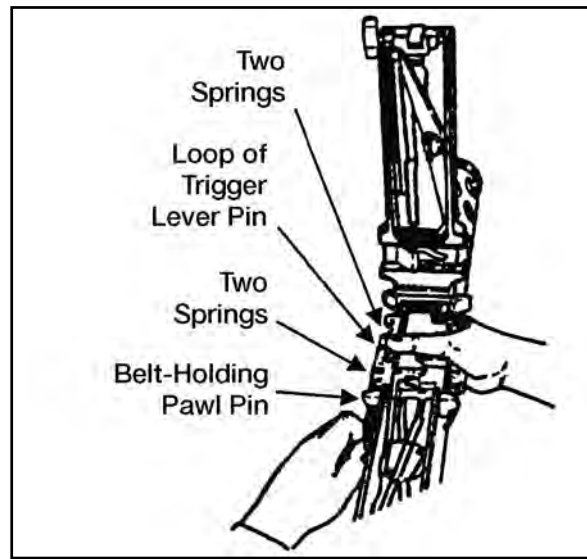


Figure 071-022-0001-21. Removal of the belt holding pawl pin, assembly, and springs

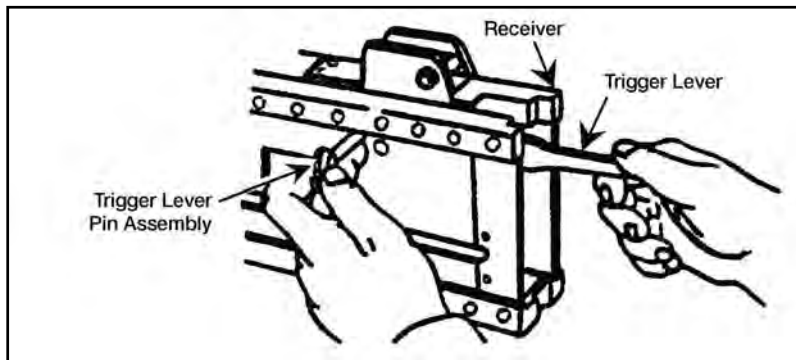
(3) Raise the loop of the trigger lever pin and rotate it into a vertical position. Reach inside the receiver, grasp the trigger lever, and remove the trigger pin assembly and trigger lever (figure 071-022-0001-22).

---

---

**Performance Steps**

---



**Figure 071-022-0001-22. Removal of the trigger lever pin assembly and trigger lever**

**3. Clean the .50 caliber machine gun and components.**

**a. Barrel assembly.**

**(1)** Clean the bore. Screw the bore brush into the cleaning rod, dip the bore brush in RBC, and push the cleaning rod through the chamber end of barrel. Unscrew the bore brush from the cleaning rod. Repeat the process until clean.

**(2)** Clean the chamber. Screw the chamber brush into the cleaning rod, dip the chamber brush in RBC, and clean the chamber using a clockwise twisting motion.

**(3)** Insert a cleaning swab in the cleaning rod and swab out the bore from the chamber end and back. Repeat until a swab comes out clean.

**(4)** Wipe outside surfaces of barrel with carbon removing compound.

**(5)** Remove all traces of RBC before lubricating.

**Note.** Do not submerge the backplate assembly in any fluid.

**b. Backplate assembly.** Use only clean wiping rags to remove foreign matter from backplate.

**c. Bolt assembly.** Clean all parts of bolt assembly with a cleaning swab saturated with carbon removing compound. Clean the face of the bolt with a cleaning swab soaked in RBC.

---

---

**Performance Steps**

---

**d.** Clean barrel buffer assembly, barrel extension assembly, and receiver assembly with a cleaning swab saturated with carbon removing compound. Wipe all parts dry with clean wiping rags.

**e.** Clean components.

**(1)** T&E mechanism. Remove foreign matter with a clean dry wiping rag. Use a small arms cleaning brush to clean numbers on the scale.

**(2)** Clean M3 tripod, MK64 gun cradle mount, and pintle with a cleaning swab saturated with carbon removing compound. Wipe all parts dry with clean wiping rags.

**f.** Ammunition. Remove foreign matter with a clean dry wiping rag.

**4.** Inspect for serviceability.

**a.** Barrel assembly.

**(1)** Check barrel locking notches for wear.

**(2)** Check the bore for bulges, missing bands, and large pits.

**b.** Backplate assembly.

**(1)** Check guides for burrs and bends.

**(2)** Check backplate latch and backplate lock for proper functioning.

**(3)** Make sure locking pins are in place.

**(4)** Check trigger and bolt latch release for proper functioning.

**(5)** Make sure handle grips do not move freely and are not cracked.

**c.** Driving rod assembly.

**(1)** Check for flat spots on springs.

**(2)** Make sure springs operate freely and rod and pin are not bent.

**d.** Bolt assembly.

**(1)** Check movement of cartridge extractor in bolt; it should raise and lower without binding. Check movement of cartridge ejector.

**(2)** Check bolt switch, cocking lever pin, cocking lever, accelerator stop lock, accelerator stop, and sear slide for cracks, bends, and burrs.

**(3)** Inspect sear for cracks and burrs. Inspect sear notch for wear, chips, and burrs. Inspect sear spring for breaks and lack of tension.

**(4)** Inspect firing pin for cracks and chipped or sharp tip. Tip should be smooth and well rounded.

---

---

**Performance Steps**

---

(5) Check firing pin extension for cracks, burrs, and free movement in bolt.

(6) Make sure bolt is free of burrs and cracks and firing pin hole is not visually out of round.

**e.** Barrel buffer assembly.

(1) Inspect buffer body lock for tension, staking, and retention in barrel buffer body.

(2) Inspect buffer accelerator for broken claws or chipped tips.

(3) Inspect accelerator pin assembly for broken or missing spring.

(4) Inspect buffer spring for cracks or breaks.

(5) Inspect breech lock depressors. They must have slight vertical (up and down) movement but should have no lateral (side to side) movement.

**f.** Barrel extension assembly.

(1) Make sure barrel extension assembly is not bent and the bolt guideways are smooth and free of burrs.

(2) Inspect threads of barrel extension assembly for damage.

(3) Make sure barrel locking spring is staked and fully seated in its groove. Also, make sure the locking end of the spring has good tension and the lug is not damaged.

(4) Check breechblock for smooth movement in guideways of barrel extension assembly.

**g.** Receiver and cover assembly.

(1) Inspect belt holding pawl brackets for looseness, bends, and cracks.

(2) Inspect side plates for bends that would affect movement of any internal parts.

(3) Check for cracks and burrs at backplate grooves.

(4) Check operation of rear sight. Make sure windage and elevation screws function properly, leaf assembly has good spring tension, and sight assembly is secured tightly to receiver.

(5) Make sure bolt stop is present and in good condition.

(6) Make sure trigger lever moves freely.

(7) Make sure trigger lever pin locks in place.

(8) Make sure cotter pin is in place on extractor switch.

---

---

**Performance Steps**

---

**(9)** Check retracting slide assembly for visible damage. Check retracting slide handles for smooth movement. Make sure cotter pins are present and in good condition, and safety wire is in place and properly laced.

**h.** Inspect components.

**(1)** T&E mechanism.

**(a)** Inspect hand wheels and threads for burrs and rust. Check hand wheels for smooth operation.

**(b)** Make sure traversing slide lock lever has spring action. Make sure elevating mechanism sleeve fits on traversing bar and clamps firmly.

**(c)** Check traversing and elevating scales for legibility.

**(d)** Inspect quick release pin and chain for burrs and rust. Check quick release pin for presence of spring loaded balls.

**(2)** M3 tripod.

**(a)** Check for completeness of tripod. Make sure all nuts and bolts are tightly secured.

**(b)** Check for visible cracks on legs and tripod head.

**(c)** Check for missing, broken, or inoperative sleeve lock latch.

**(d)** Check pintle lock assembly. Check surfaces of pintle, bolt, and nut for burrs and rust. Make sure cotter pin is present and in good condition.

**(e)** Check locking action of front leg clamping assembly.

**(f)** Check that rear legs lock in the open position. Make sure sleeve latch notch and right leg slide notch engage completely. Make sure latch spring has good tension.

**(g)** Check telescoping, indexing, and locking action of rear legs and front leg clamping assembly.

**(3)** MK64 gun cradle mount.

**(a)** Check for missing or damaged parts.

**(b)** Check for rust, cracks, and burrs.

**(c)** Check pintle lock assembly. Check surfaces of pintle, bolt, and nut for burrs and rust. Make sure cotter pin is present and in good condition.

**i.** Inspect ammunition. Check for damage or corroded rounds.

**5.** Lubricate the .50 caliber machine gun.

---

---

**Performance Steps**

---

- a. Remove all traces of RBC or carbon removing compound.

**CAUTION**

Do not mix lubricants on the same weapon. The weapon must be thoroughly cleaned with dry cleaning solvent during change from one lubricant to another.

- b. Lubricate exterior of backplate with a light coat of oil. Do not lubricate interior of backplate.

- c. Lubricate all other parts with a light coat of LSA or CLP (at temperatures above 0 degrees Fahrenheit) or LAW (at temperatures below 0 degrees Fahrenheit).

6. Assemble the .50 caliber machine gun.

- a. Assemble the trigger lever (Figure 071-022-0001-23).

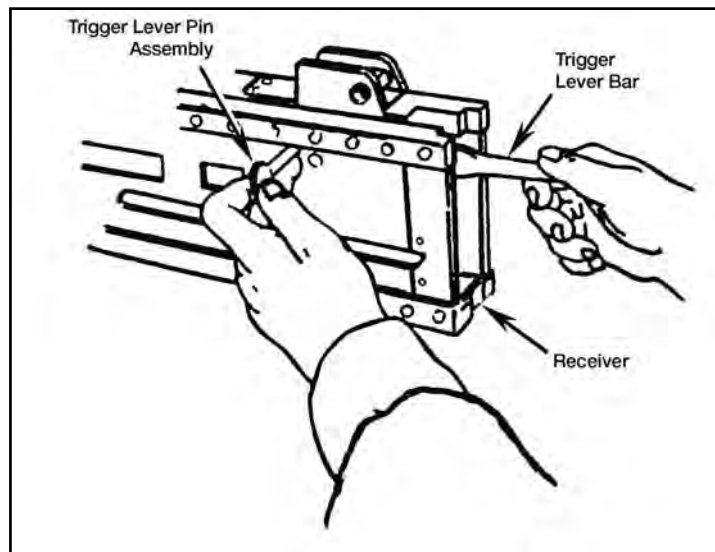


Figure 071-022-0001-23. Assembly of the trigger lever

- (1) Place the trigger lever bar in the receiver directly under the timing nut so the hole in the trigger lever bar is aligned with the mounting hole in the receiver.

- (2) Insert trigger lever pin assembly (loop end vertical) in the assembly hole on left side of receiver. Match key on trigger lever pin with keyway in side plate of receiver and install the pin completely.
-

---

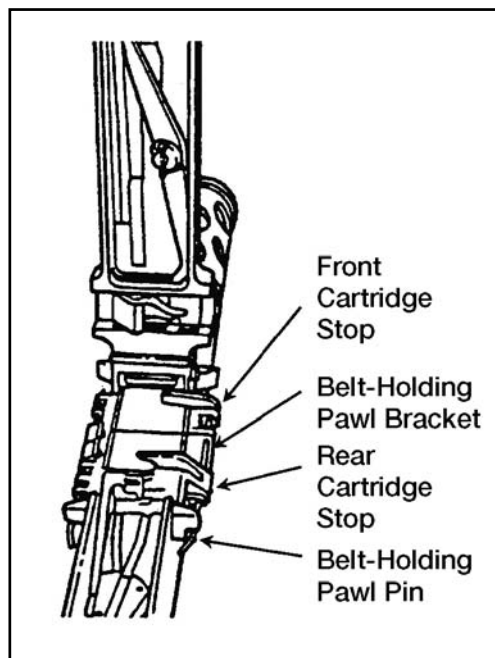
**Performance Steps**

---

(3) Rotate trigger pin lever assembly 90 degrees and lock in place. Fold the loop end down.

**b.** Assemble receiver group.

(1) Determine the direction of feed. Figure 071-022-0001-24 shows left-hand feed. Place the right-hand rear cartridge stop assembly and front cartridge stop on the belt holding pawl bracket.



**Figure 071-022-0001-24. Installation of the rear cartridge stop assembly and front cartridge stop**

(2) Install belt holding pawl pin with hooked end to rear.

(3) Seat belt holding pawl springs in place on the belt holding pawl bracket.

(4) Place belt holding pawl assembly on the springs. Compress springs and insert belt holding pawl pin (figure 071-022-0001-25).

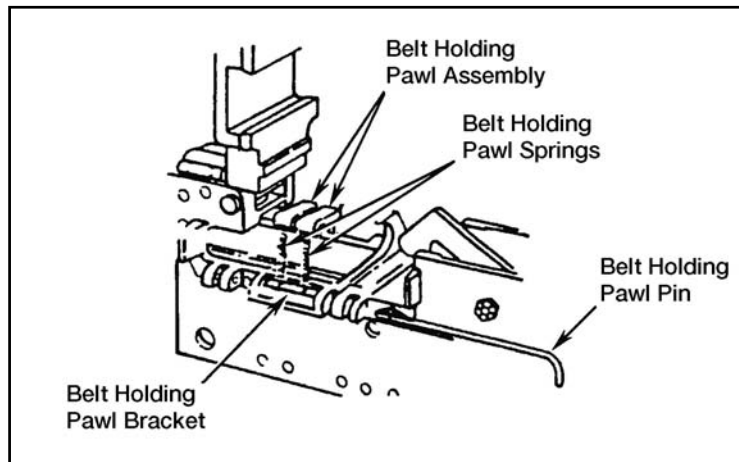
---



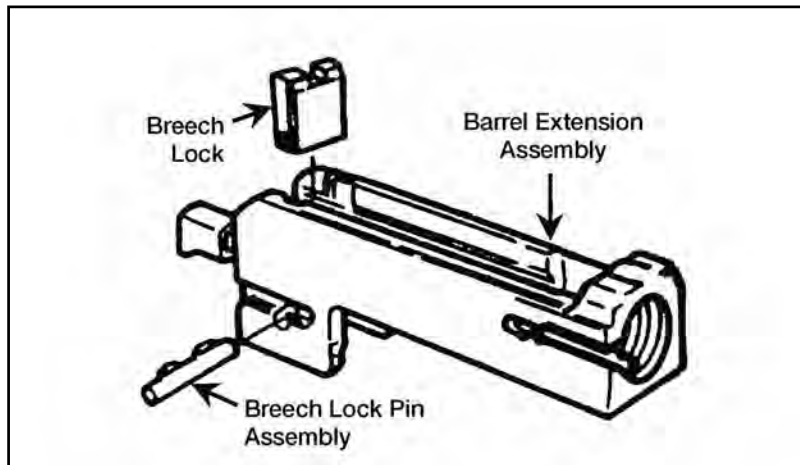
---

**Performance Steps**

---



**Figure 071-022-0001-25. Installation of the belt holding pawl assembly**  
c. Assemble barrel extension (figure 071-022-0001-26).



**Figure 071-022-0001-26. Assembly of the barrel extension assembly**

**(1)** Install breechblock lock with beveled edge up and to the front of barrel extension assembly.

---

---

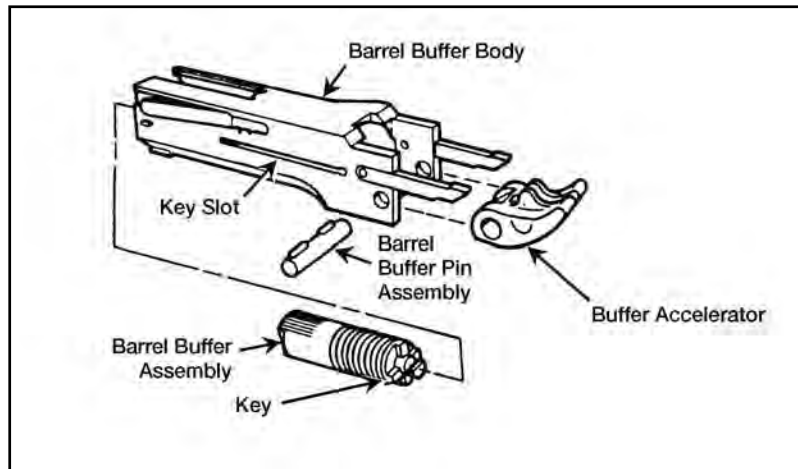
**Performance Steps**

---

(2) Install breech lock pin assembly in barrel extension. Make sure both ends of breech lock pin assembly are flush with sides of barrel extension assembly.

**d. Assemble barrel buffer assembly.**

(1) Place buffer accelerator (tips up) into barrel buffer body, align mounting holes, and install buffer pin assembly. Ensure both ends of barrel buffer pin assembly are flush with sides of barrel buffer body (figure 071-022-0001-27).



**Figure 071-022-0001-27. Assembly of the barrel buffer assembly**

(2) Align key on barrel buffer assembly with key slot in barrel buffer body and slide barrel buffer assembly into barrel buffer body.

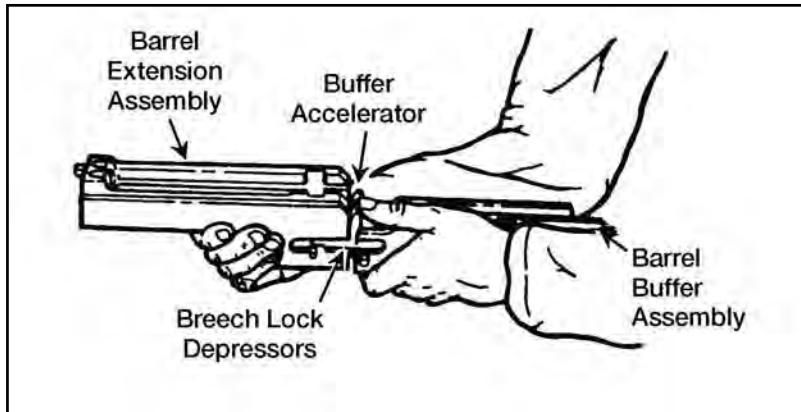
(3) Hold the barrel buffer assembly with the buffer accelerator up and engage the notch on the shank of the barrel extension assembly with the cross groove in the piston rod of the barrel assembly (figure 071-022-0001-28).

---

---

**Performance Steps**

---



**Figure 071-022-0001-28. Attachment of the barrel buffer and barrel extension assemblies**

**(4)** Align breech lock depressors in grooves of barrel extension assembly and push barrel buffer assembly forward.

**(5)** Install barrel buffer assembly and barrel extension assembly in receiver (figure 071-022-0001-29).

---

---

Performance Steps

---

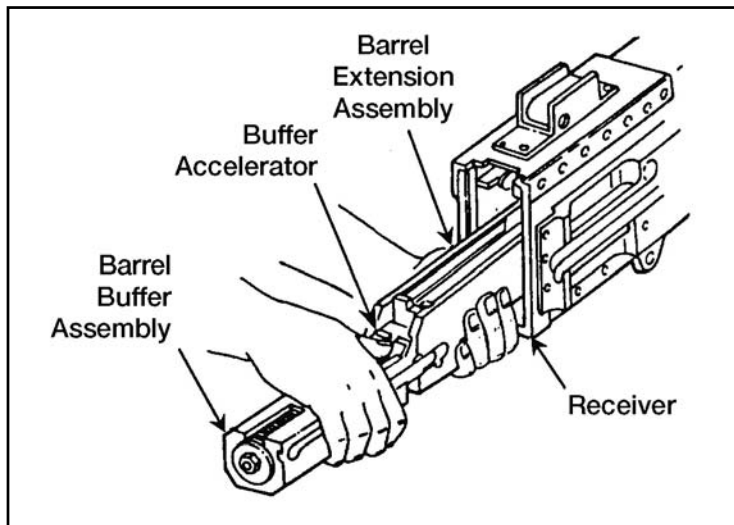


Figure 071-022-0001-29. Installation of the barrel buffer and barrel extension assemblies

e. Assemble bolt assembly.

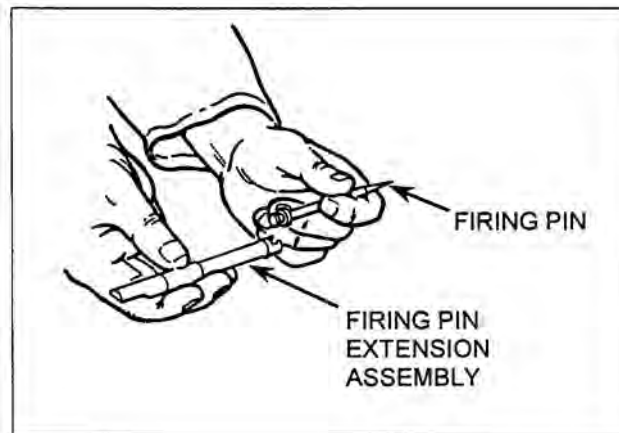
(1) Attach firing pin to firing pin extension assembly (figure 071-022-0001-30).

---

---

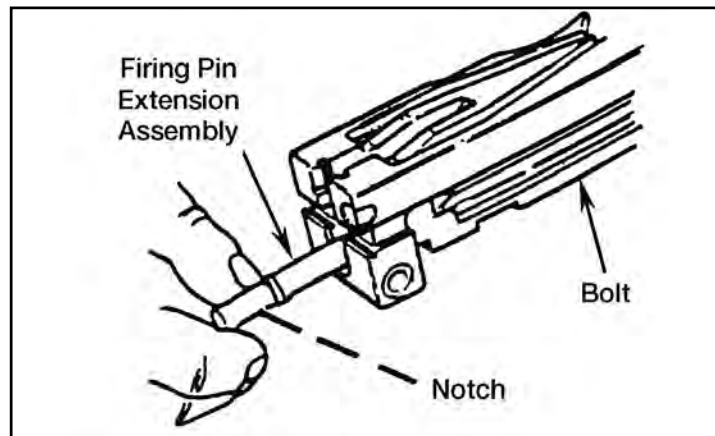
**Performance Steps**

---



**Figure 071-022-0001-30. Attachment of the firing pin to the firing pin extension assembly**

**(2)** Insert firing pin extension assembly into bolt with notch of firing pin extension assembly down (Figure 071-022-0001-31).



**Figure 071-022-0001-31. Installation of the firing pin extension assembly**

**(3)** Slide firing pin extension assembly forward so tip of firing pin protrudes from face of bolt.

---

---

**Performance Steps**

---

(4) Place sear spring in recess on bolt. Slide sear down into vertical grooves at rear of bolt with wedge-shaped lug pointed outward and upward (figure 071-022-0001-32).

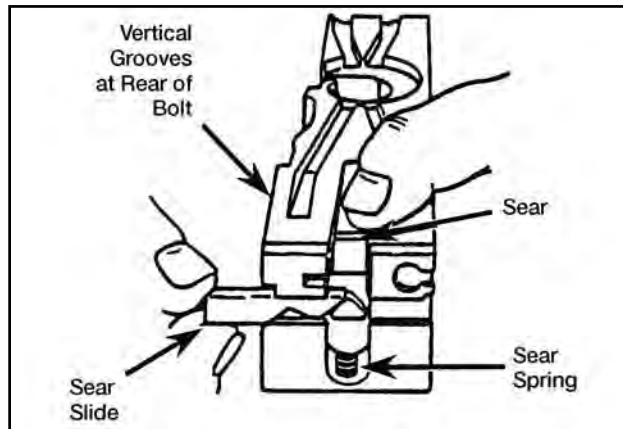


Figure 071-022-0001-32. Installation of the sear side

(5) Compress sear spring by pressing down on the sear. Install sear slide from left side of bolt in grooves of bolt with "V" notch down.

**Note.** Make sure the pin end of the accelerator is installed behind the firing pin spring, not through a coil.

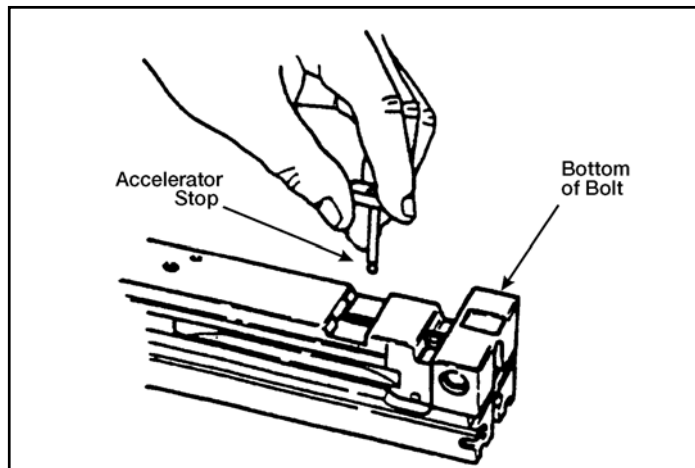
(6) Insert pin end of accelerator stop through bottom of bolt (figure 071-022-0001-33).

---

---

### Performance Steps

---



**Figure 071-022-0001-33. Attachment of the accelerator stop**

**Note.** Base end of accelerator stop should be installed with long end forward so beveled edges match.

**(7)** Turn bolt over. Place forked end of accelerator stop lock on notched end of accelerator stop.

**(8)** Using the wedge-shaped end of the cocking lever, press down on the flat end of the accelerator stop lock, and move the cocking lever into the groove on the left side of the bolt (figure 071-022-0001-34).

---

---

Performance Steps

---

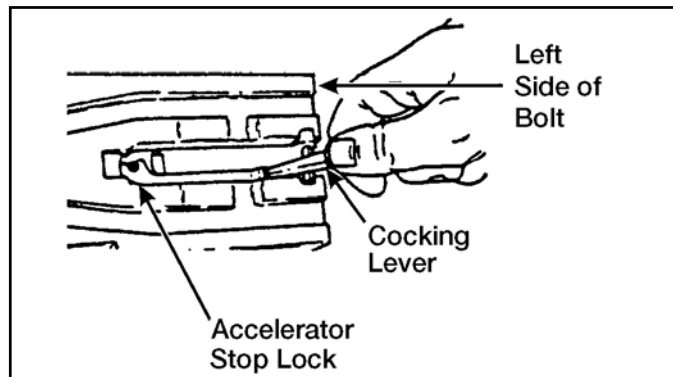


Figure 071-022-0001-34. Attachment of the accelerator stop lock

(9) Insert cocking lever, with rounded nose on lower end of lever to rear, into slot in top of bolt (figure 071-022-0001-35).

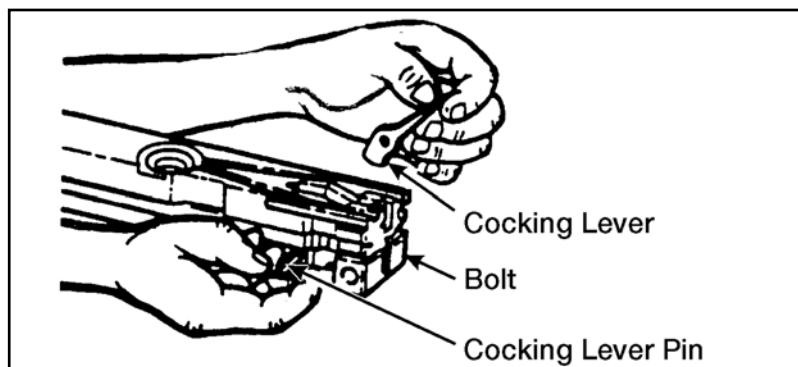


Figure 071-022-0001-35. Attachment of the cocking lever

(10) Align the hole in the cocking lever with the holes in the bolt. Insert the cocking lever pin from the left side.

(11) Push the cocking lever forward to charge the firing pin. Return the cocking lever to the rearward position.

---



---

**Performance Steps**

---

**WARNING**

Do not try to release the firing pin with the cocking lever forward. The cocking lever could spring back forcibly and cause serious injury.

(12) Test firing pin release. Trip the firing pin by depressing the top of the sear with a section of a swab-holder. If doing so makes a sharp metallic sound, the firing pin spring is in good condition (figure 071-022-0001-36).

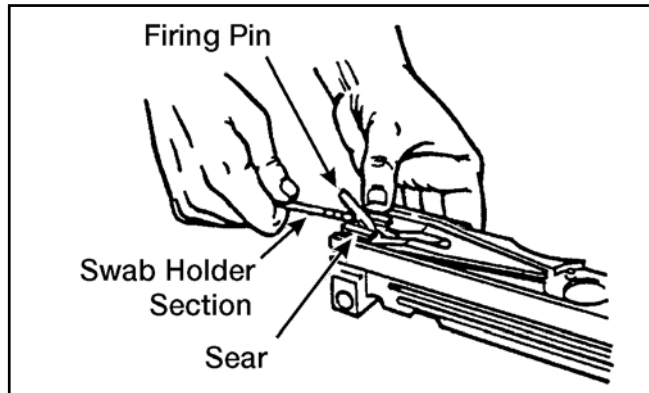


Figure 071-022-0001-36. Testing the firing pin release

(13) Place cocking lever in forward position. Determine the direction of feed before installing the bolt switch.

(14) Place bolt switch in position so the feed groove is continuous for feed direction indicated (figure 071-022-0001-37).

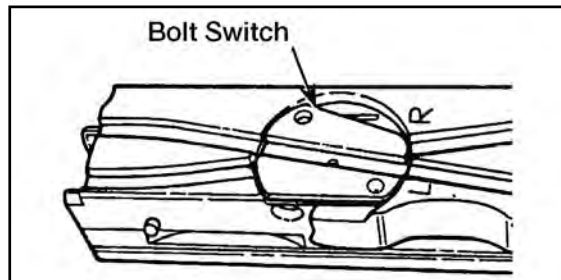


Figure 071-022-0001-37. Setting the bolt switch

---

**Performance Steps**

---

(15) Hold cartridge extractor in vertical position and insert shank end of cartridge extractor into left side of bolt. Make sure cartridge extractor fits into bolt as far as possible.

(16) Rotate cartridge extractor downward to full horizontal position. Check that flange on bottom of cartridge extractor has engaged shoulder on bolt.

(17) Ensure cocking lever is forward.

(18) Push bolt assembly forward into receiver until bolt latch engages notches in top of bolt assembly (figure 071-022-0001-38).

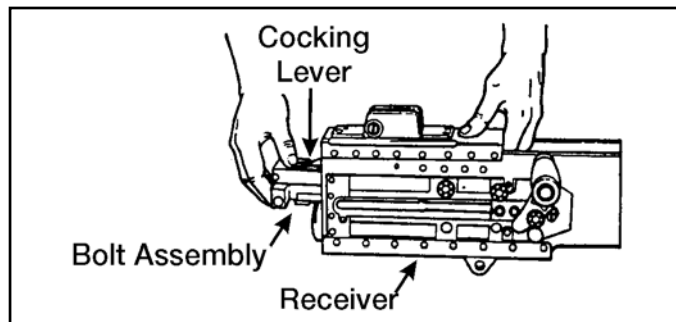


Figure 071-022-0001-38. Installation of the bolt assembly

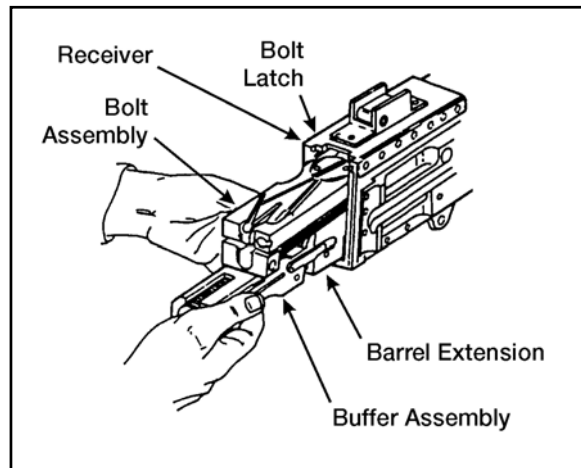
(19) If you cannot install the bolt this way, remove the barrel extension and buffer assembly from the receiver. Install the bolt assembly into the barrel extension and buffer assembly, then install them in the receiver (figure 071-022-0001-39).

---

---

**Performance Steps**

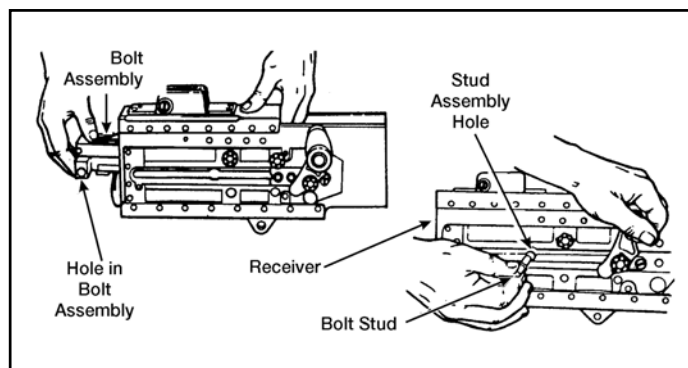
---



**Figure 071-022-0001-39. Installation of the bolt assembly within the barrel extension and buffer assembly**

**(20)** Raise bolt latch and push bolt assembly into the receiver.

**(21)** Align holes in bolt assembly with stud assembly hole in receiver and install bolt stud in hole in bolt assembly. Place bolt in forward position (figure 071-022-0001-40).



**Figure 071-022-0001-40. Installation of the bolt assembly**

---

---

**Performance Steps**

---

f. Assemble driving spring rod assembly (figure 071-022-0001-41). Install the driving spring rod assembly in the upper right corner of the bolt. Push forward and to the right until the driving spring rod assembly engages in the hole in the side plate of the receiver—not in the groove for the backplate.

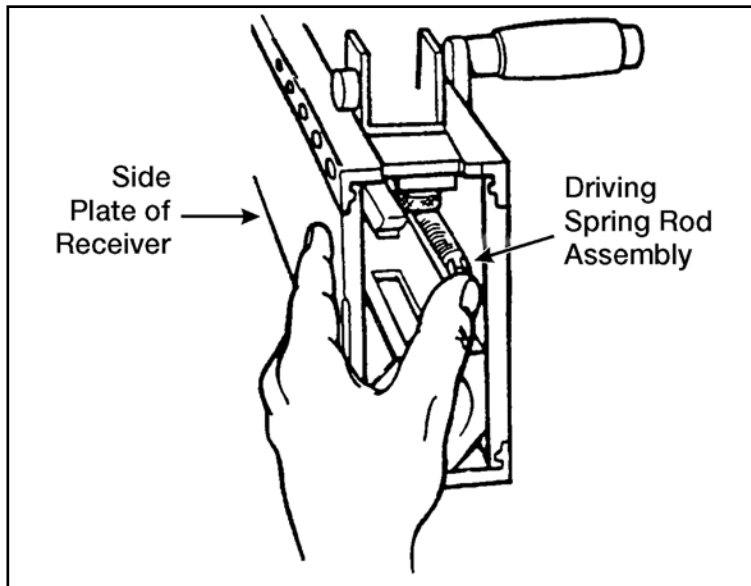


Figure 071-022-0001-41. Installation of the driving spring rod assembly

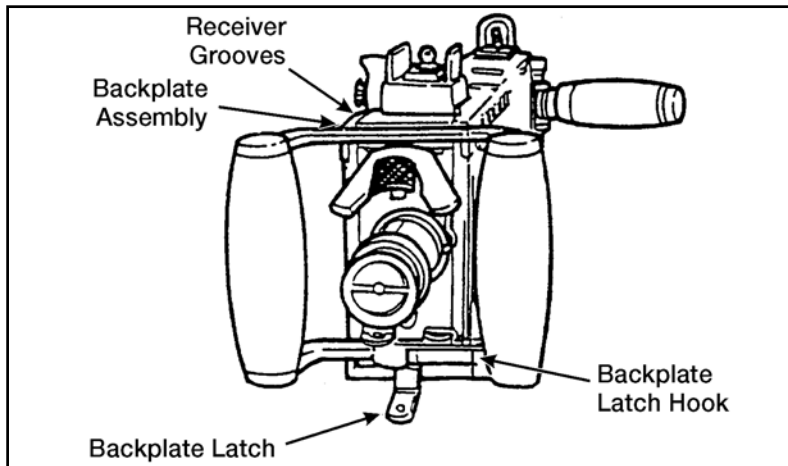
g. Install backplate assembly (figure 071-022-0001-42).

---

---

**Performance Steps**

---



**Figure 071-022-0001-42. Installation of the backplate assembly**

(1) Align backplate assembly with receiver grooves. Pull backplate latch lock while lifting up on backplate latch. Lower backplate assembly down until engaged in receiver.

(2) Test proper locking by pulling up on backplate assembly.

**h. Assemble barrel assembly.**

(1) Retract bolt far enough for barrel locking spring lug to center in barrel locking spring hole on right side of receiver.

(2) Place the smallest loop of a caliber .50 link between the trunnion block and the barrel extension. This holds the barrel locking spring lug aligned with the 3/8-inch hole.

(3) Install and screw barrel assembly completely into receiver. Unscrew barrel assembly two clicks and check headspace.

**7. Perform a function check to make sure weapon is assembled correctly.**

**a. Place the weapon in the single-shot mode.**

**b. Open the cover and pull the retracting slide handle to the rear. Bolt should lock to rear in single-shot mode.**

**c. Hold the retracting slide handle to the rear; depress bolt latch release and ease the bolt forward.**

**d. Press trigger; weapon should fire.**

---

---

**Performance Steps**

---

- e. Place the weapon in the automatic-fire mode.
  - f. Pull the retracting slide handle to the rear and hold. Bolt should not lock to rear in automatic-fire mode.
  - g. Release pressure on the retracting slide handle and ease the bolt forward.
  - h. Press trigger; weapon should fire.
- 

**Evaluation Preparation:**

*Setup:* At the test site, provide the soldier with equipment listed in conditions. Use performance steps in the training outline to evaluate soldier's performance of the task.

*Brief Soldier:* Tell the soldier to clear, disassemble, clean, inspect, lubricate, assemble, and perform a function check on the weapon.

Performance Measures	GO	NO GO
1. Cleared the weapon.	___	___
2. Disassembled the weapon without damaging any parts.	___	___
3. Cleaned the weapon, components, and ammunition.	___	___
4. Identified any damaged, worn, or malfunctioning parts.	___	___
5. Lubricated weapon using the correct lubrication technique.	___	___
6. Assembled weapon in correct sequence without damaging any parts.	___	___
7. Performed a function check.	___	___

**Evaluation Guidance:** Score the soldier GO if all performance measures are passed. Score the soldier NO GO if any performance measure is failed. If the soldier scores NO GO, show him what was done wrong and how to do it correctly.

**References****Required****Related**

FM 23-65

TM 9-1005-213-10

---

**071-022-0003****Load a Caliber .50 M2 Machine Gun**

**Conditions:** Given a cleared caliber.50 machine gun, mounted on a tripod or cupola, and linked caliber.50 ammunition.

**Standards:** Loaded the linked ammunition in the feed tray groove so, when the cover was closed, a round remained in the tray groove and the ammunition fed correctly.

---

**Performance Steps**

---

1. Check to ensure weapon is clear.
2. Load ammunition.
  - a. Ensure the bolt is forward and the cover is closed.
  - b. Insert the double-loop end of the belt in the feed tray until the belt-holding pawl engages the first round.
  - c. With the palm of your hand facing up, pull the retracting slide handle to the rear and release it. (If the bolt latch release is up, return the retracting slide handle to the forward position then release the bolt.)
  - d. With the palm of your hand facing up, pull the retracting slide handle to the rear a second time and release it. When the bolt goes forward the second time, the gun is loaded.
  - e. To set the gun in automatic mode, lock the bolt-latch release down.
  - f. To set gun in single-shot mode, keep the bolt-latch release unlocked and in the up position. Release it manually for each round.

---

**Evaluation Preparation:**

*Setup:* Provide the soldier with equipment and materials listed in the conditions. Evaluate this task in a classroom or training area using dummy linked caliber.50 ammunition.

*Brief Soldier:* Tell the soldier to load the weapon using the belt of ammunition.

Performance Measures	GO	NO GO
1. Ensured the bolt was forward and the cover was closed.	___	___
2. Inserted the double-loop end of the belt into the feed way until the belt-holding pawl held the first round.	___	___

Performance Measures	GO	NO GO
3. Pulled the retracting slide handle to the rear and released it. If the bolt latch release was up, returned the retracting slide handle to the forward position, then released the bolt.	_____	_____
4. Pulled the retracting slide handle to the rear a second time and released it. When the bolt went forward the second time, the gun was loaded.	_____	_____

**Evaluation Guidance:** Score the soldier GO if all performance measures are passed. Score the soldier NO GO if any performance measure is failed. If the soldier scores NO GO, show him what was done wrong and how to do it correctly.

#### References

##### Required

##### Related

FM 23-65

TM 9-1005-213-10

---

## 071-022-0004

### Unload a Caliber .50 M2 Machine Gun

**Conditions:** Given a caliber .50 M2 machine gun, mounted on a tripod or cupola, loaded with linked caliber .50 ammunition.

**Standards:** Removed all ammunition and links from the machine gun. Cleared the weapon, ensured the chamber was empty and the weapon was in the single-shot mode.

---

#### Performance Steps

1. Unload a cold weapon (less than 200 rounds have been fired from the weapon).
    - a. Keep gun oriented on target area.
    - b. Place the gun in the single-shot mode.
    - c. Raise the cover.
    - d. Lift the extractor away from the ammunition belt.
    - e. Remove the ammunition belt from the feed-way.
    - f. With palm up, pull the retracting slide handle to the rear to lock the bolt to the rear.
-





Performance Measures	GO	NO GO
7. Held charging handle and released the bolt, allowing it to move slowly forward.	___	___
8. Pressed the trigger.	___	___

**Evaluation Guidance:** Score the soldier GO if all performance measures are passed. Score the soldier NO GO if any performance measure is failed. If the soldier scores NO GO, show him what was done wrong and how to do it correctly.

**References**

**Required**

**Related**

FM 23-65

TM 9-1005-213-10

---

**071-313-3454**

**Engage Targets with a Caliber .50 M2 Machine Gun**

**Conditions:** Given a zeroed caliber .50 machine gun (tripod or cupola mounted), linked caliber .50 ammunition, and a sector of fire with engageable targets.

**Standards:** Fired the caliber .50 machine gun to engage targets in your assigned sector of fire. Applied the correct target-engagement techniques so the entire target was covered with fire.

---

**Performance Steps**

1. Assume a suitable firing position. Based on your situation, assume a firing position that will allow you to observe and engage targets, but reduce your exposure to enemy fire.

a. Prone position (figure 071-313-3454-1).

---

---

**Performance Steps**

---



**Figure 071-313-3454-1. Prone position (tripod mount)**

**b. Sitting position (figure 071-313-3454-2).**



**Figure 071-313-3454-2. Sitting position (tripod mount)**

**c. Standing position (figure 071-313-3454-3).**

---

---

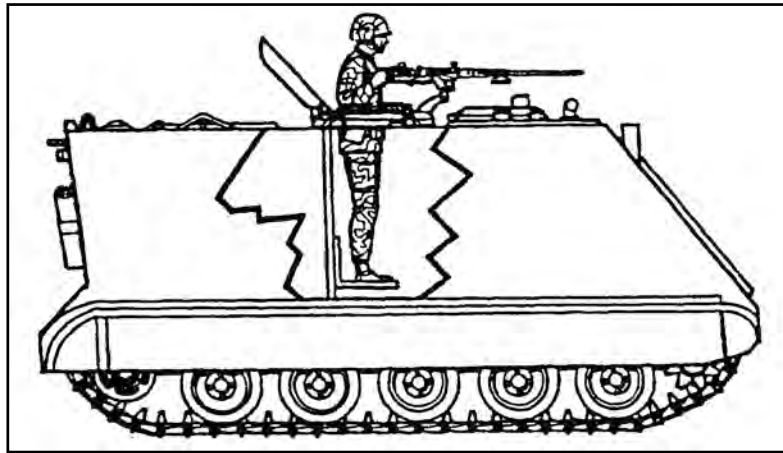
**Performance Steps**

---



**Figure 071-313-3454-3. Standing position (tripod mount)**

**d. Standing position for cupola-mounted gun (figure 071-313-3454-4).**



**Figure 071-313-3454-4. Standing position (cupola mount)**

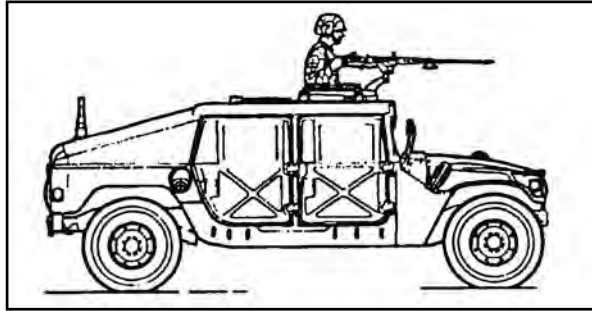
**e. Standing position for high-mobility, multipurpose wheeled vehicle (HMMWV)-mounted gun (figure 071-313-3454-5).**

---

---

**Performance Steps**

---



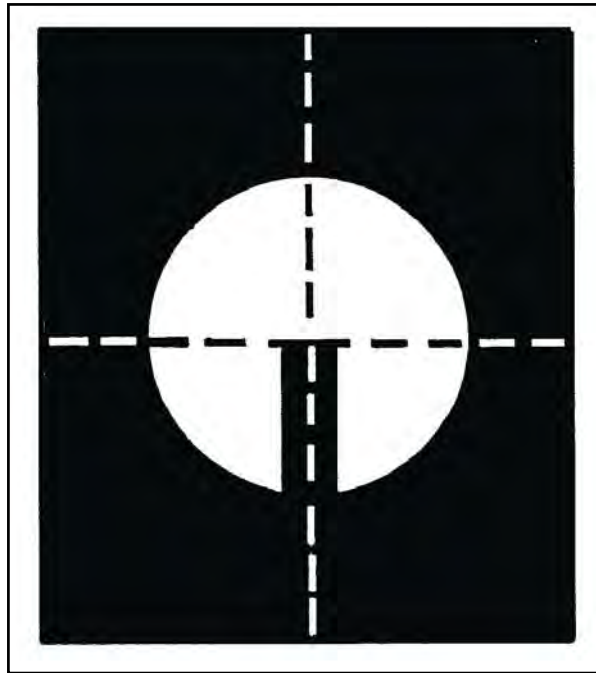
**Figure 071-313-3454-5. Standing position (HMMWV mount)**

2. Obtain the correct sight picture.
    - a. Sight alignment. Center the front sight post in the peep sight (figure 071-313-3454-6).
-

---

**Performance Steps**

---



**Figure 071-313-3454-6. Correct sight alignment**

**b.** Sight picture. Place top center of front sight blade at bottom center of intended target (figure 071-313-3454-7).

---

---

**Performance Steps**

---



**Figure 071-313-3454-7. Correct sight picture**

- 3.** Apply the correct engagement technique based on target type (figure 071-313-3454-8).
-

---

Performance Steps

---

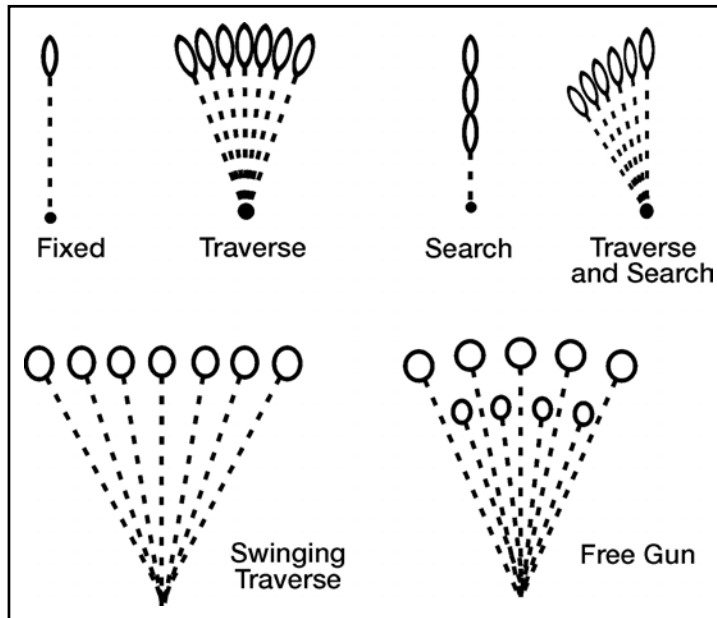


Figure 071-313-3454-8. Techniques of fire with respect to the gun

a. Use the correct gun manipulation technique.

(1) Fixed fire. Refers to fire delivered against a point target. Only one aiming point is necessary, with little or no manipulation of the gun.

(2) Traversing fire. Refers to fire distributed against a wide target, requiring successive changes in the gun direction. To distribute fire laterally, use the T&E mechanism to traverse the gun left or right.

(3) Searching fire. Refers to fire delivered against a deep target or a linear target with depth by successively changing elevation. To distribute fire in depth, use the T&E mechanism to move the muzzle of the weapon up or down.

(4) Traversing and searching fire. Refers to fire delivered in width and depth by successive changes in direction and elevation. Use this type of fire against a target whose long axis is oblique to the direction of fire.

(5) Swinging traverse. Refers to fire delivered against targets that require major changes in direction but little or no change in elevation. Loosen the traversing slide lock enough to swing the gun laterally.

---



---

**Performance Steps**

---

(6) Free gun. Refers to fire delivered against moving targets that must be rapidly engaged with fast changes in direction and elevation. To fire free gun, remove the T&E mechanism.

b. Correctly apply fire to engage specific targets.

(1) Point target. Engage point targets with fixed fire using a single aiming point (figure 071-313-3454-9).



Figure 071-313-3454-9. Point target

(2) Linear target. Initially aim at the midpoint of the target. Traverse fire to one flank and then to the other to cover the entire target (figure 071-313-3454-10).

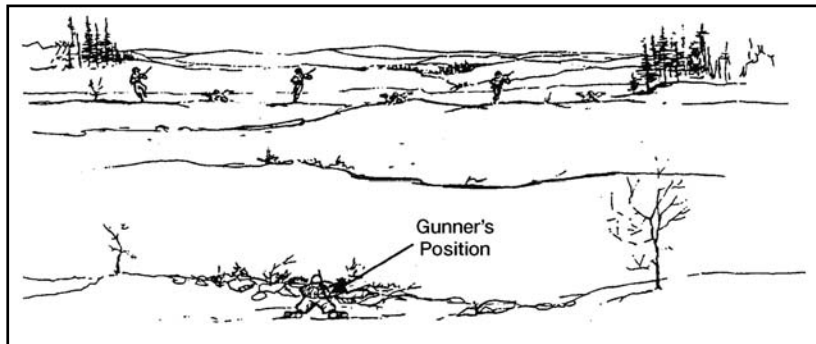


Figure 071-313-3454-10. Linear target and one gun

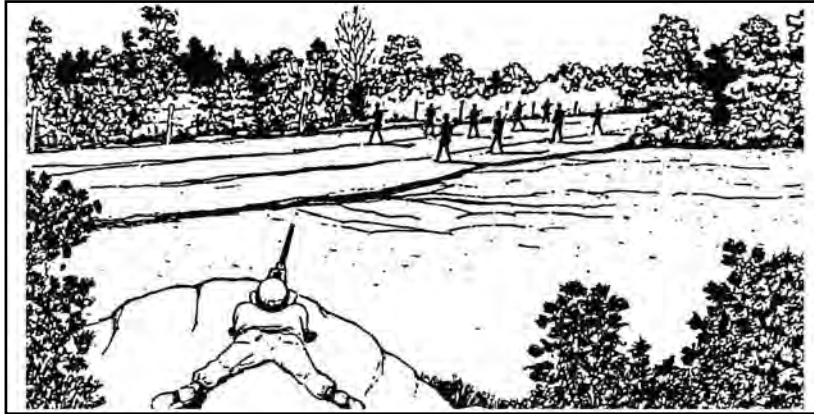
(3) Linear target with depth. Initially aim at the midpoint of the target, unless another portion of the target is more critical or presents a greater threat. Traverse and search to the flank closest to your position, then back to the other flank, so you cover the entire target (figure 071-313-3454-11).

---

---

**Performance Steps**

---



**Figure 071-313-3454-11. Linear target with depth**

(4) Deep target. Initially aim at the midpoint of the target, unless another portion of the target is more critical or presents a greater threat. Search down to the near end, then search up to the far end (figure 071-313-3454-12).



**Figure 071-313-3454-12. Deep target**

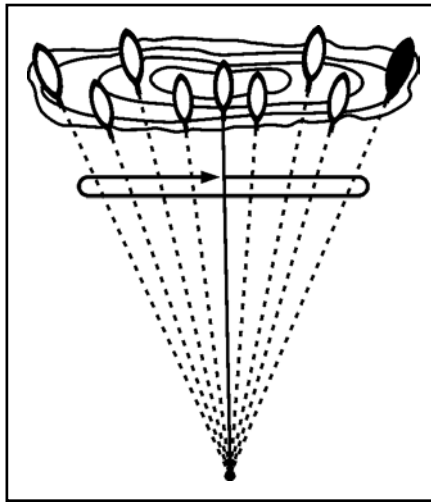
(5) Area target. Initially aim at midpoint of the target area. Traverse and search to either flank, then traverse and search to the opposite flank (figure 071-313-3454-13).

---

---

**Performance Steps**

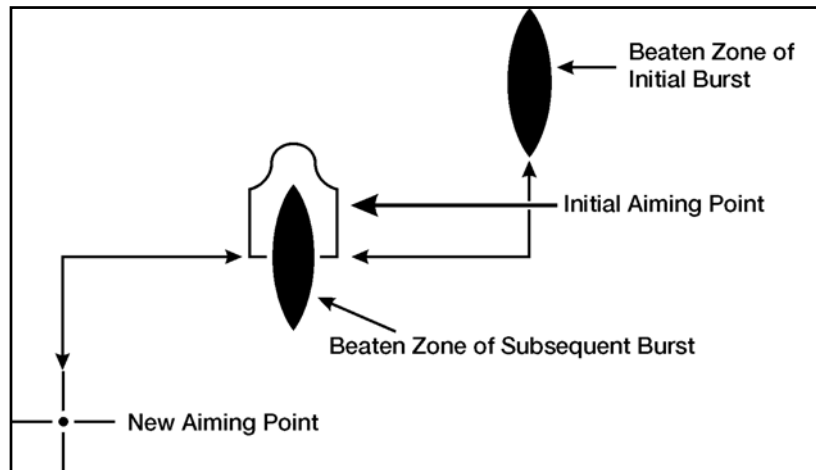
---



**Figure 071-313-3454-13. Engagement of area targets**

- 4.** Observe fire and adjust the aiming point to place effective fire on the target.
    - a.** Observation of fire. Observe bursts of fire by noting tracers in flight or the strike of the rounds in the target area.
    - b.** Adjusted aiming point. Adjust fire quickly without adjusting the sight. If the initial burst misses the target, rapidly select a new aiming point the same distance from the center of impact of the initial burst but in the opposite direction. Fire a second burst (figure 071-313-3454-14).
-

**Performance Steps**



**Figure 071-313-3454-14. Adjusted aiming point method**

5. Fire on the targets until they are all destroyed, or until you receive an order to cease fire.

**Evaluation Preparation:**

*Setup:* Evaluate this task on a 10-meter live-fire range equipped with the basic machine gun target pasters (FSN 6920-078-5128). Provide the soldier with a caliber .50 M2 machine gun (tripod mounted) with 236 rounds of linked caliber .50 ammunition (117 rounds for practice and 119 rounds for qualification). Conduct 10-meter firing according to FM 23-65, appendix C, table I.

*Brief Soldier:* Tell the soldier he will fire table I according to FM 23-65, appendix C (brief the conditions, standards, and ammunition). Tell the soldier that, when you instruct him to fire, you will evaluate his ability to apply correct target engagement techniques and to place effective fire on targets.

Performance Measures	GO	NO GO
1. Assumed a suitable firing position.	___	___
2. Applied correct engagement technique based on target type.	___	___
a. Used correct gun manipulation technique.		
b. Used correct application of fire to engage specific targets.		

Performance Measures	GO	NO GO
3. Placed effective fire on targets (score a minimum of 84 points).	—	—

**Evaluation Guidance:** Score the soldier GO if all performance measures are passed. Score the soldier NO GO if any performance measure is failed. If the soldier scores NO GO, show him what was done wrong and how to do it correctly.

#### References

##### Required

##### Related

FM 23-65

TM 9-1005-213-10

### SUBJECT AREA 15: M136 LAUNCHER

#### 071-054-0001

##### Prepare an M136 Launcher for Firing

**Conditions:** Given an M136 launcher (AT4) and a requirement to prepare it for firing.

**Standards:** Performed prefire checks on the M136 AT4 and prepared the round for firing.

##### Performance Steps

**Note.** Because the M136 launcher is issued as a round of ammunition rather than as a weapon, the launcher is completely used; therefore, inspection is limited to visual examination of the external components.

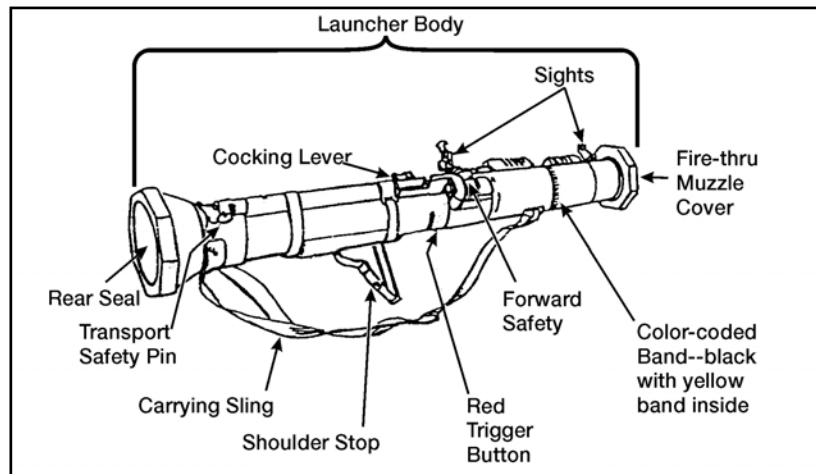
1. Perform the prefire checks. The overall condition of the launcher should be inspected before it is used (figure 071-054-0001-1). The firer should ensure—
  - a. The transport safety pin is in place and fully seated and the lanyard is attached.
  - b. The cocking lever is in the SAFE position and folded down.
  - c. The fire-through muzzle cover is intact. If the seal is torn, it should be removed to ensure that no foreign objects have gotten into the launcher.
  - d. The launcher's color-coded band is the correct color: black for high-explosive antitank, gold for target-practice tracers, and blue for field-handling trainers.

---

**Performance Steps**

---

- e. The sights function properly. Open the sight covers to ensure the sights pop up and are not damaged.
- f. The red safety catch does not move when depressed.
- g. The rear seal is not damaged.
- h. The shoulder stop is not broken or damaged and it unsnaps and folds down.
- i. The carrying sling is not frayed and is attached to the launcher.
- j. The launcher body has no cracks, dents, or bulges.



**Figure 071-054-0001-1. Parts of the M136 launcher to be inspected**

- 2. Prepare the launcher for firing. Preparation procedures are—
    - a. Remove the launcher from the carrying position and cradle it with the left arm (figure 071-054-0001-2).
-

---

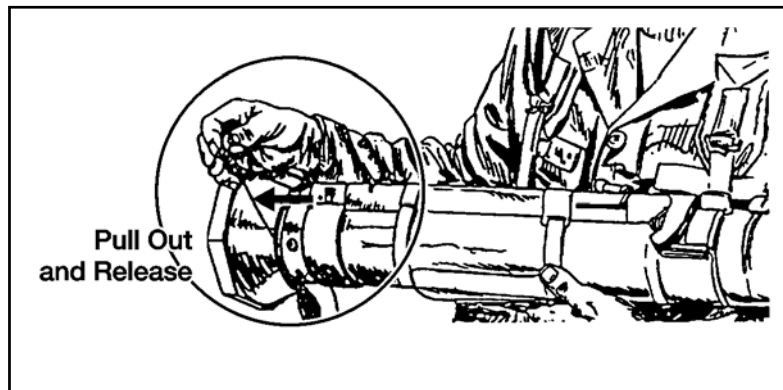
**Performance Steps**

---



**Figure 071-054-0001-2. Cradle position**

**b.** While cradling the launcher, pull the transport safety pin with the right hand and release it (figure 071-054-0001-3).



**Figure 071-054-0001-3. Removing the transport safety pin**

---

**Performance Steps**

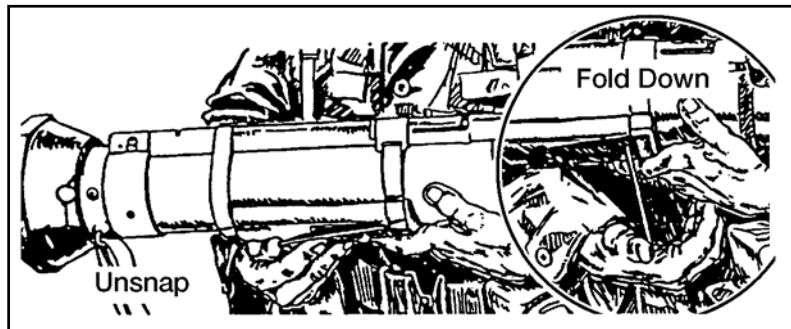
---

**Note.** Ensure the transport safety pin is attached to the launcher by its lanyard. If the launcher has no lanyard, place the transport safety pin in your pocket. If the launcher remains unfired, reinsert the transport safety pin.

**WARNINGS**

Make sure personnel wear earplugs.  
Point the weapon toward the target.  
Clear the back blast area.

- c. Unsnap and unfold the shoulder stop (figure 071-054-0001-4).



**Figure 071-054-0001-4. Unsnapping the shoulder stop**

- d. With the shoulder stop in position, place the launcher on the right shoulder.
- e. With the launcher on the right shoulder and supported with the left hand, release the front sight by pressing down on the sight cover and sliding it to the rear. Release the rear sight by pressing down on the cover and sliding it forward. Sliding the covers off allows the sights to pop up.
- f. Check the backblast area.
- g. Cock the launcher by unfolding the cocking lever with the right hand. Place the thumb of the right hand under the cocking lever. Grip the front of the firing mechanism for support. Push the cocking lever forward to the right. Let the cocking lever slide back (figure 071-054-0001-5).
-



---

Performance Steps

---

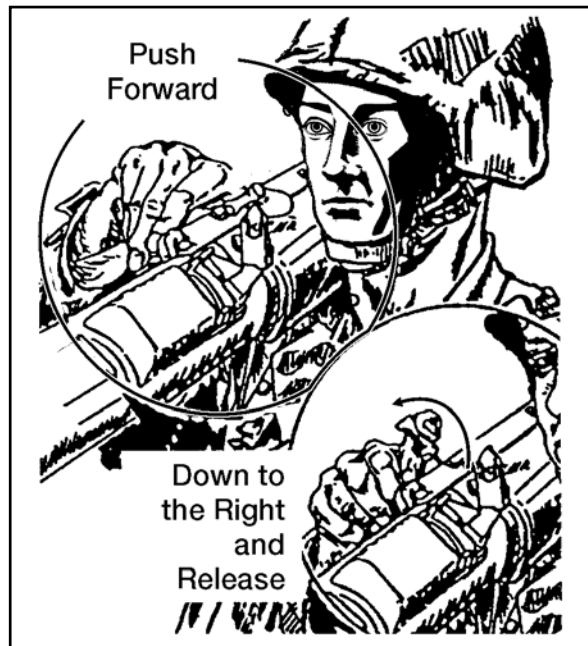


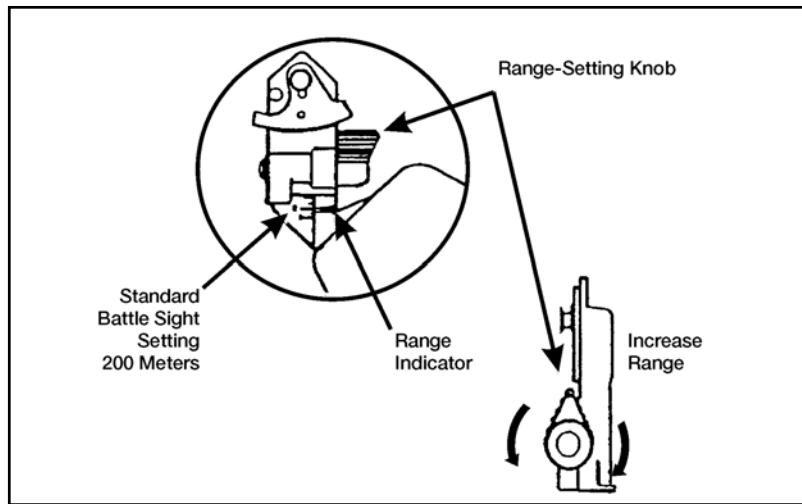
Figure 071-054-0001-5. Cocking the launcher

h. Adjust the rear sight for the required range.

(1) When closing the sight cover, set the sight on a range of 200 meters. When the rear sight is uncovered, the battlesight setting is 200 meters. If the range to the target is more than 200 meters but less than 250 meters, no sight adjustment is required (figure 071-054-0001-6).

---

**Performance Steps**



**Figure 071-054-0001-6. Adjusting the rear sight**

(2) To adjust the rear sight range setting to more than 200 meters, turn the range knob clockwise (toward the muzzle). To decrease the range, turn the range knob counterclockwise (toward the gunner). There is a click at each 50-meter increment; this sound aids you during limited visibility (figure 071-054-0001-6).

**Evaluation Preparation:**

*Setup:* At the test site, provide an expended AT4 or a tracer trainer in the carrying configuration; have the soldier place it in the carrying position. Tell the soldier the range to the target. Ask the soldier when the rear sight requires adjustment.

*Brief Soldier:* Tell the soldier to prepare the launcher to fire. Tell the soldier he will be required to answer questions about the launcher.

Performance Measures	GO	NO GO
1. Performed the prefire checks.	___	___
a. Checked the transport safety pin.		
b. Ensured the cocking lever was on SAFE.		
c. Checked the fire-through muzzle cover.		
d. Checked the color-coded band.		

Performance Measures	GO	NO GO
e. Checked the front and rear sights.		
f. Checked the red safety catch.		
g. Checked the rear seal.		
h. Checked the shoulder stop.		
i. Checked the carrying sling.		
j. Checked the body of the launcher.		
2. Prepared the launcher for firing.	___	___
a. Removed the transport safety pin.		
b. Unsnapped and unfolded the shoulder stop.		
c. Placed the launcher on the right shoulder.		
d. Released the front and rear sights.		
e. Checked the back-blast area.		
f. Cocked the launcher.		
g. Adjusted the rear sight.		

**Evaluation Guidance:** Score the soldier GO if all performance measures are passed. Score the soldier NO GO if any performance measure is failed. If the soldier scores NO GO, show him what was done wrong and how to do it correctly.

**References**

**Required**

**Related**

FM 3-23.25

---

**071-054-0002**

**Restore an M136 Launcher to Carrying Configuration**

**Conditions:** Given an M136 launcher (AT4) prepared for firing and the requirement to restore the launcher to carrying configuration.

**Standards:** Restored the launcher to a safe carrying configuration without damaging the equipment.

---

**Performance Steps**

**Note:** The launcher is prepared for immediate firing but is not fired.

1. If the gunner remains in the same position, he should—

---

---

**Performance Steps**

---

(a) Release the red safety catch (this step applies only if the firing sequence has proceeded to this point).

(b) Return the cocking lever to the SAFE (uncocked) position by pushing it up and to the left, then pulling it rearward and fold the cocking lever down.

(c) Keep the launcher pointed at the target area, and remove the launcher from his shoulder.

(d) Replace the transport safety pin, with the launcher cradled in his left arm.

2. If the gunner is to move to another position, in addition to the steps shown above, he must—

(a) Return the rear sight to the battlesight setting of 200 meters, fold down the front and rear sights, and close the sight covers.

**CAUTION**

The rear sight may be damaged if it is not returned to a battlesight setting of 200 meters before closing the sight cover.

(b) Fold the shoulder stop and snap it back into position.

---

**Evaluation Preparation:**

*Setup:* At the test site, provide an expended AT4 or a tracer trainer. The AT4 or tracer trainer is in the ready to fire configuration.

*Brief Soldier:* Tell the soldier to assume a correct standing, ready-to-fire position with the launcher. Once he has assumed the firing position, tell him to return the launcher to the carrying configuration.

Performance Measures	GO	NO GO
<i>Note.</i> The performance measures are scored in sequence.		
1. Released the red safety catch.	___	___
2. Returned the cocking lever to the SAFE position and folded the cocking lever down.	___	___
3. Removed the launcher from the shoulder and cradled it with the left arm.	___	___
4. Replaced the transport safety pin.	___	___
5. Returned the rear sight to the battlesight setting.	___	___
6. Folded and covered the sights.	___	___
7. Folded the shoulder stop and snapped it in place.	___	___

**Evaluation Guidance:** Score the soldier GO if all performance measures are passed. Score the soldier NO GO if any performance measure is failed. If the soldier scores NO GO, show him what was done wrong and how to do it correctly.

**References**

**Required**

**Related**

FM 3-23.25

TM 9-1315-886-12

**SUBJECT AREA 16: M203 GRENADE LAUNCHER**

**071-311-2125**

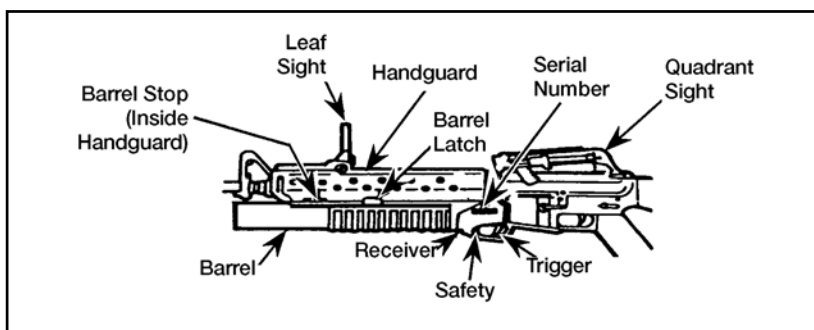
**Maintain an M203 Grenade Launcher**

**Conditions:** Given an M203 grenade launcher; cleaner, lubricant, preservative (CLP); thong; bore brush; and clean rags.

**Standards:** Cleared the M203 grenade launcher; disassembled the M203; cleaned and lubricated the M203; inspected the M203 before assembly; assembled the M203; and performed a function check on the M203.

**Performance Steps**

1. Clear the M203 grenade launcher.
2. Disassemble the M203 (figure 071-311-2125-1).



**Figure 071-311-2125-1. Components of the M203 grenade launcher**

---

**Performance Steps**

---

**WARNING**

Before disassembling the weapon, clear the rifle and grenade launcher.

- a. Remove the quadrant sight (if used) by loosening the knurled screw on the right side (figure 071-311-2125-2).

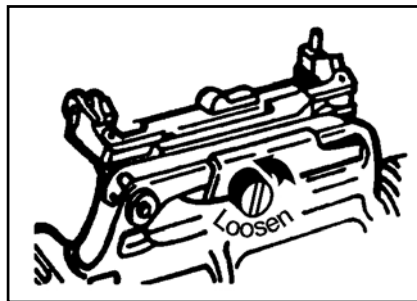


Figure 071-311-2125-2. Removing quadrant sight

- b. Pull back the slip ring. Lift up on the handguard and pull it to the rear to remove (figure 071-311-2125-3).

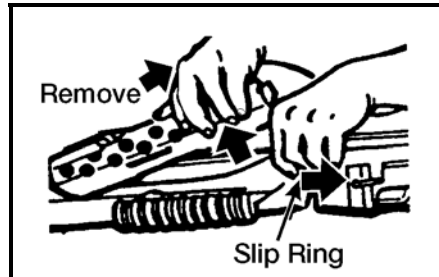


Figure 071-311-2125-3. Removing handguard

- c. Press the barrel latch and move the barrel forward to the barrel stop (figure 071-311-2125-4).
-

---

**Performance Steps**

---

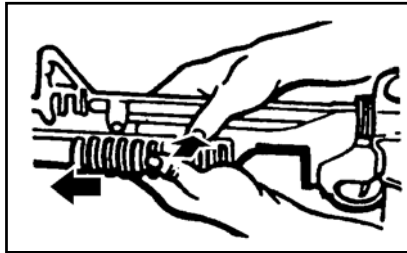


Figure 071-311-2125-4. Unlocking and opening the M203 barrel

d. Press the barrel stop to release the barrel from the receiver and remove the barrel (figure 071-311-2125-5).

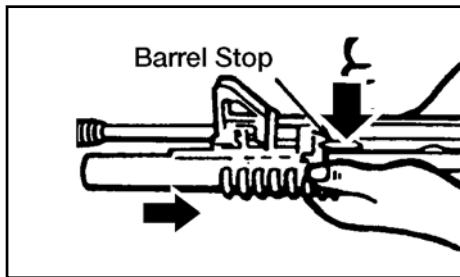


Figure 071-311-2125-5. Removing the M203 barrel

**Note.** Further disassembly may be performed only by the armorer.

**3.** Clean and lubricate the M203.

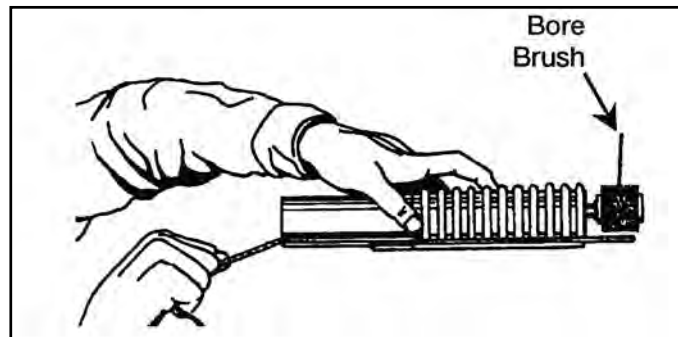
**a.** Bore. Attach a clean, dry rag to the thong and thoroughly moisten the rag with CLP. Pull the rag through the bore several times. Attach the bore brush to the thong, pull it through the bore several times, and follow this with more rags, moistened with CLP, if needed (figure 071-311-2125-6). Pull dry rags through the bore and inspect each rag as it is removed. The bore is clean when a dry rag is removed unfouled. Pull a rag lightly moistened with CLP through the bore to leave a light coat of lubricant inside the barrel.

---

---

**Performance Steps**

---



**Figure 071-311-2125-6. Cleaning the M203 barrel**

**b.** Breech insert. Clean the face of the breech insert retainer with a patch and CLP. Remove the CLP cleaner with dry rags, then lubricate the breech with a light coat of CLP.

**c.** All other parts. Use a brush and dry rags to clean all other parts and surfaces. Apply a light coat of CLP to the exterior of the launcher after cleaning.

**d.** Safety mechanism. Clean the safety mechanism properly with CLP. Lubricate the safety with CLP.

**Note.** For cleaning the rifle portion of the launcher, refer to Task 071-311-2025.

**4.** Inspect the M203 before assembly.

**a.** Check handguard for cracks, dents, or distortion that prevent its firm attachment to the rifle.

**b.** Check leaf sight for bent or damaged parts and for rust or corrosion.

**c.** Check leaf sight for legibility of marking.

**d.** Check barrel for cracks and general condition. Inspect all parts for wear and damage.

**e.** Check for burrs, scratches, nicks, or other damage.

**5.** Assemble the M203.

**a.** Press the barrel stop. Slide the barrel into the receiver (figure 071-311-2125-7).

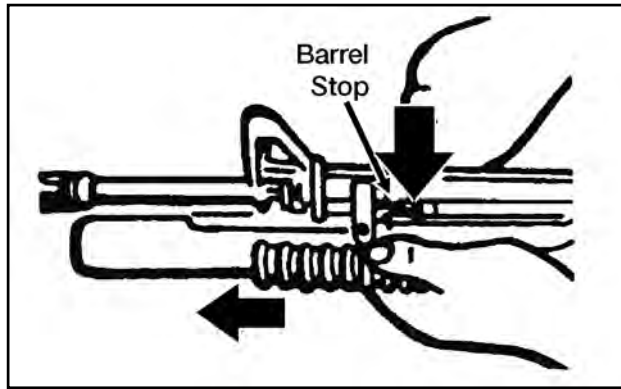
---



---

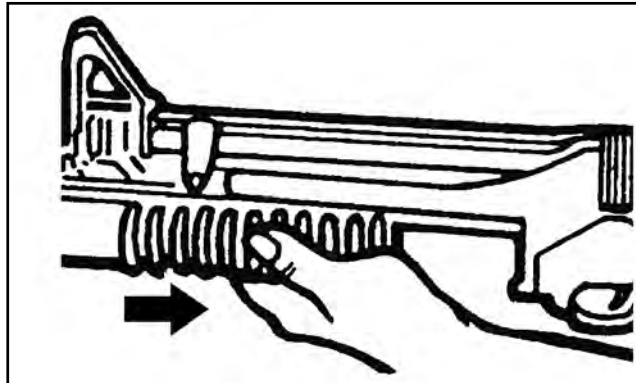
**Performance Steps**

---



**Figure 071-311-2125-7. Installing the M203 barrel**

**b.** Move the barrel rearward to lock (figure 071-311-2125-8).



**Figure 071-311-2125-8. Locking the M203 barrel**

**c.** Install the handguard and secure with the slip ring (figure 071-311-2125-9).

---

---

Performance Steps

---

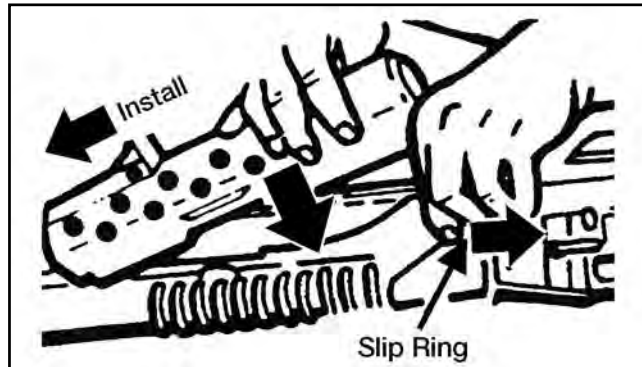


Figure 071-311-2125-9. Installing the handguard

- d. Install the quadrant sight (figure 071-311-2125-10).

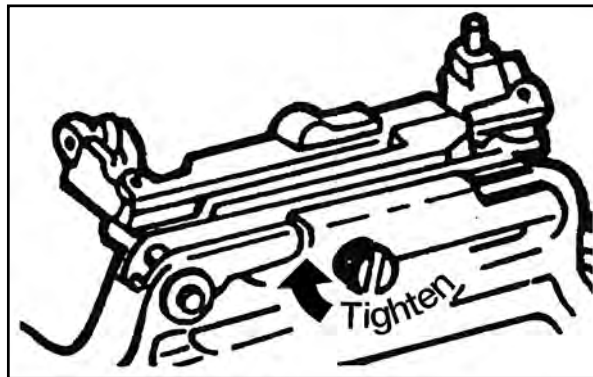


Figure 071-311-2125-10. Installing the quadrant sight

6. Perform a function check on the M203.
- a. Check the proper operation of the sears. Cock the launcher and pull the trigger. The firing pin should release. Hold the trigger to the rear and cock the launcher. Release the trigger, then pull. The firing pin should release.
  - b. Check the safety in both SAFE and FIRE positions with trigger. Launcher must be cocked before safety can be placed in SAFE position.
-

---

**Performance Steps**

---

c. Check the leaf sight windage adjustment screw for proper operation. Do not move the elevation adjustment screw if the weapon has been zeroed.

d. Move barrel forward and back to be sure the stop and barrel latch function.

---

**Evaluation Preparation:**

*Setup:* At the test site, provide all materials and equipment given in the task conditions.

*Brief Soldier:* Tell the soldier he will perform unit maintenance on the M203 grenade launcher.

Performance Measures	GO	NO GO
1. Cleared the M203 grenade launcher.	___	___
2. Disassembled the M203.	___	___
a. Removed the quadrant sight.		
b. Pulled back the slip ring.		
c. Moved the barrel forward to the barrel stop.		
d. Removed the barrel.		
3. Cleaned and lubricated the M203.	___	___
a. Cleaned the bore.		
b. Cleaned the breech insert.		
c. Cleaned all other parts.		
d. Cleaned the safety mechanism.		
4. Inspected the M203 before assembly.	___	___
a. Checked the handguard.		
b. Checked the leaf sight.		
c. Checked the barrel.		
d. Checked for burrs, scratches, and other damage.		
5. Assembled the M203.	___	___
a. Slid the barrel into the receiver.		
b. Closed the barrel.		
c. Installed the handguard.		
d. Installed the quadrant sight.		

Performance Measures	GO	NO GO
6. Performed a function check on the M203.	___	___
a. Checked operation of the sears.		
b. Checked safety in both the SAFE and the FIRE positions.		
c. Checked the leaf sight windage adjustment screws for proper operation.		
d. Checked the barrel latch and the stop function.		

**Evaluation Guidance:** Score the soldier GO if all performance measures are passed. Score the soldier NO GO if any performance measure is failed. If the soldier scores NO GO, show him what was done wrong and how to do it correctly.

#### References

##### Required

##### Related

FM 23-31

TM 9-1010-221-10

---

## 071-311-2127

### Load an M203 Grenade Launcher

**Conditions:** Given an M203 grenade launcher, ammunition, and a requirement to load the weapon.

**Standards:** Inserted ammunition into the chamber without damaging the equipment or injuring personnel. Followed all safety procedures in accordance with TM 9-1010-221-10.

---

#### Performance Steps

<b>WARNING</b>
----------------

Keep muzzle down range and clear of all troops.
---

1. Ensure that the safety switch is in the SAFE ("S") position until ready to fire.
  2. Depress the barrel latch.
  3. Slide the barrel assembly forward (extraction and cocking automatically take place during this step).
  4. Before loading, make sure that the bore and chamber are clean and dry.
- 

3-516

071-311-2127

---

**Performance Steps**

---

5. Insert the ammunition into the chamber.

**WARNING**

Do not fire pyrotechnic ammunition made for the AN-M8 pyrotechnic pistol in the M203 grenade launcher. Make sure you have the right ammunition. Never load aircraft ammunition M384 (HE) or M385 (practice). It could result in serious injury.

6. Slide the barrel closed until it locks and clicks.
- 

**Evaluation Preparation:**

*Setup:* At the test site, in an outside field environment, provide all equipment and materials listed in the task condition statement.

*Brief Soldier:* Tell the soldier to load the M203 grenade launcher and to perform all steps correctly.

Performance Measures	GO	NO GO
1. Ensured that the safety switch was in the SAFE ("S") position until ready to fire.	___	___
2. Pressed the latch and slid the barrel forward.	___	___
3. Before loading, made sure that the bore and chamber were cleaned and dried.	___	___
4. Inserted the ammunition into the chamber.	___	___
5. Slid the barrel closed until it locked and clicked.	___	___

**Evaluation Guidance:** Score the soldier GO if all performance measures are passed. Score the soldier NO GO if any performance measure is failed. If the soldier scores NO GO, show him what was done wrong and how to do it correctly.

**References****Required****Related**

FM 23-31

TM 9-1010-221-10

---

## 071-311-2128

### Unload an M203 Grenade Launcher

**Conditions:** Given a loaded M203 grenade launcher and a requirement to unload it.

**Standards:** Pressed the latch and moved the barrel forward to eject ammunition. Caught the round as it dropped.

---

#### Performance Steps

**Note.** If weapon has been fired and only shell casing is in chamber, disregard step 3 and the requirement for slow movement in step 4.

1. Place safety in the ON position.
2. Depress the barrel latch.
3. Place one hand under the barrel assembly forward of the trigger guard.
4. Slowly slide the barrel assembly forward (the round will eject).
5. Secure the round.

---

#### Evaluation Preparation:

*Setup:* At the test site, in an outside field environment, provide all equipment and materials listed in the task conditions statement.

*Brief Soldier:* Tell the soldier to unload the M203 grenade launcher, performing all steps correctly.

Performance Measures	GO	NO GO
1. Pressed the latch.	___	___
2. Moved the barrel forward.	___	___
<b>Note.</b> The round extracts and ejects automatically.		
3. Caught the round—did not let it drop.	___	___

**Evaluation Guidance:** Score the soldier GO if all performance measures are passed. Score the soldier NO GO if any performance measure is failed. If the soldier scores NO GO, show him what was done wrong and how to do it correctly.

#### References

**Required**

**Related**

FM 23-31

TM 9-1010-221-10

3-518

071-311-2128

---

## 071-311-2129

### Correct Malfunctions of an M203 Grenade Launcher

**Conditions:** Given an M203 grenade launcher mounted on an M16-series rifle and 40-mm ammunition. The grenade launcher has failed to function or fire.

**Standards:** Corrected malfunctions of an M203 grenade launcher. Followed all safety precautions according to TM 9-1010-221-10.

---

#### Performance Steps

---

1. Keep the weapon pointed at the target and keep all soldiers clear of the muzzle (at least 80 meters or 264 feet).

**Note.** M203 malfunctions consist of hangfires and misfires. A hangfire is a delay in the propellant's igniting. A misfire is a failure to fire. Both are handled in the same way because they are often indistinguishable.

2. Wait 30 seconds from the time of the failure to fire, then open the breech.

3. Remove the round from the breech.

a. Release the barrel latch.

b. Slide the barrel forward to eject the round.

c. Either catch the ejected round or reduce the distance the round falls by holding the weapon close to the ground.

d. If the round does not eject, tap the casing with the rifle cleaning rod.

e. If the casing cannot be removed, notify the NCOIC or unit maintenance.

4. Examine the primer to determine whether the round or the firing mechanism is defective.

a. If the primer is dented, keep the damaged round separate from other ammunition until it can be disposed of properly.

b. If the primer is not dented, the firing mechanism is faulty. Report it to the NCOIC or unit maintenance.

**Note.** If the primer is not dented, the round may be reloaded on an operational M203.

---

#### Evaluation Preparation:

**Setup:** Provide all materials listed in the task conditions. Use dummy ammunition for training.

**Brief Soldier:** Tell the soldier he must assume a firing position to apply any required immediate action.

Performance Measures	GO	NO GO
1. Kept the weapon pointed at the target and kept all troops clear of the muzzle (at least 80 meters or 264 feet).	—	—
2. Waited 30 seconds from the time of the failure to fire, then opened the breech.	—	—
3. Removed the round from the breech.	—	—
a. Released the barrel latch.		
b. Slid the barrel forward to eject the round.		
c. Caught either the ejected round or reduced the distance the round fell by holding the weapon close to the ground.		
d. If the round did not eject, tapped the casing with the rifle cleaning rod.		
e. If casing could not be removed, notified the NCOIC or unit maintenance.		
4. Examined the primer to determine whether the round or the firing mechanism was defective.	—	—
a. If the primer was dented, kept the damaged round separate from other ammunition until it could be disposed of properly.		
b. If the primer was not dented, reported the faulty firing mechanism to the NCOIC or unit maintenance.		

**Evaluation Guidance:** Score the soldier GO if all performance measures are passed. Score the soldier NO GO if any performance measure is failed. If the soldier scores NO GO, show him what was done wrong and how to do it correctly.

#### References

##### Required

##### Related

FM 23-31

TM 9-1010-221-10



---

## 071-311-2130

### Engage Targets with an M203 Grenade Launcher

**Conditions:** Given a zeroed M203 grenade launcher mounted on an M16-series or M4-series rifle, enemy targets located within engagement ranges, and sufficient ammunition.

**Standards:** Destroyed or disabled enemy targets without causing injury or death to friendly personnel.

---

#### Performance Steps

---

**Note.** This task may be performed using either of two sights found on the system.

#### WARNING

Keep muzzle pointed downrange and clear of all friendly troops.

1. Keep the safety in the SAFE position until ready to fire.
2. Load the M203 grenade launcher (Task 071-311-2127).

#### WARNING

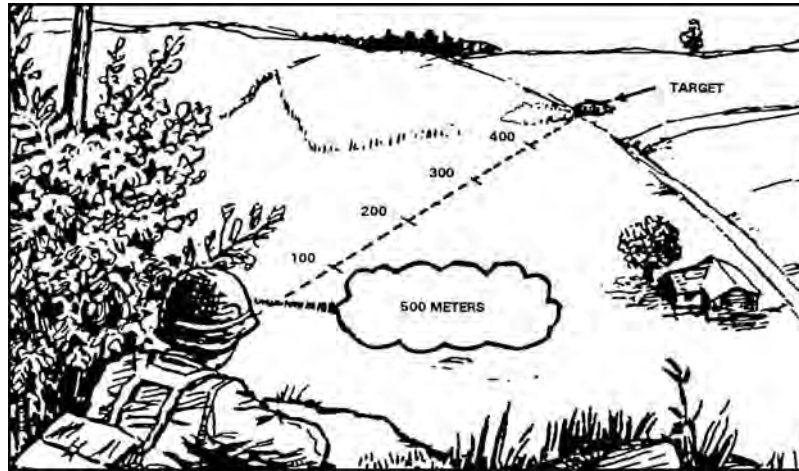
Fire high-explosive (HE) grenades at targets within 130 meters (427 feet) (minimum safe) only from a protected position. When training (minimum safe), do not fire at targets within 130 meters (427 feet). In combat, do not fire at targets closer than 31 meters (102 feet).

3. Determine range to target (figure 071-311-2130-1).
-

---

**Performance Steps**

---



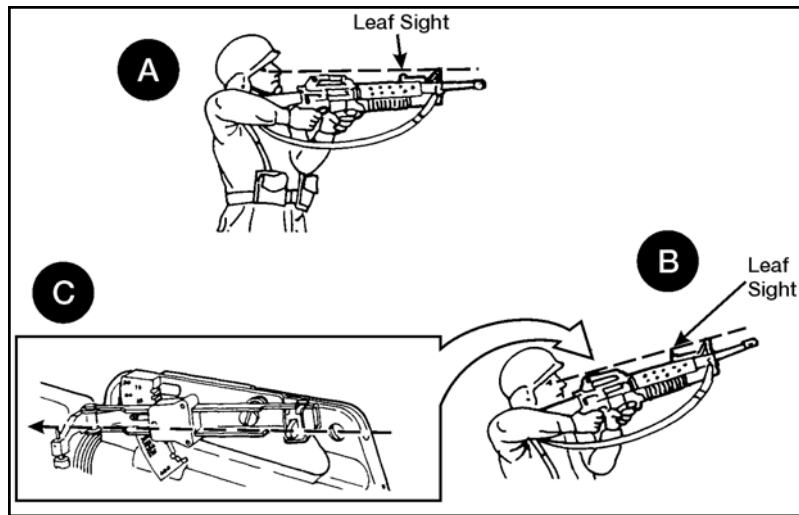
**Figure 071-311-2130-1. Range estimation**

4. Determine if target is engageable.
  5. Determine if target should be engaged.
  6. Select the appropriate firing technique based on target range (figure 071-311-2130-2).
-

---

**Performance Steps**

---



**Figure 071-311-2130-2. Firing techniques**

**a.** For short-range targets at 50 meters or less, place the leaf sight down and use the rifle sights (A, figure 071-311-2130-2).

**Note.** Estimate distance to target and aim head high on the target.

**b.** For targets from 50 to 250 meters, raise the leaf sight and use with the rifle front sight (B, figure 071-311-2130-2).

**c.** For targets from 250 to 400 meters, use the front and rear sight of the quadrant sight only (C, figure 071-311-2130-2).

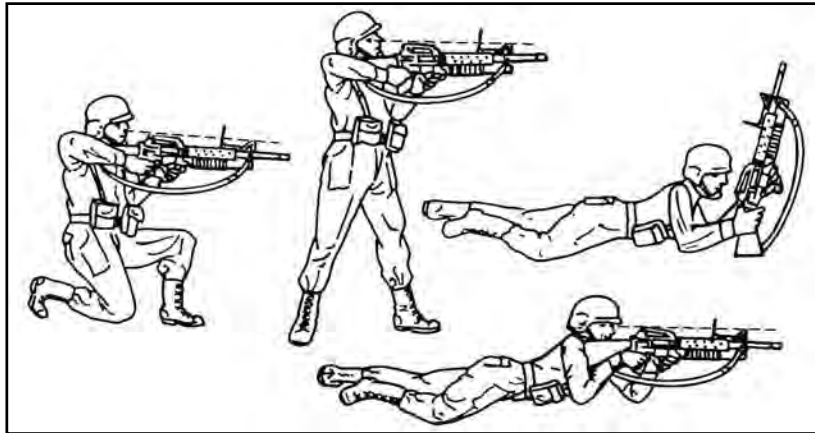
**7.** Select and assume an appropriate firing position (figure 071-311-2130-3).

---

---

**Performance Steps**

---



**Figure 071-311-2130-3. Firing positions**

**Note.** Launcher may be fired from the standing, kneeling, or prone position.

**a.** Place the stock of the weapon on the ground when firing long range from the prone position.

**b.** Hold the stock firmly against your shoulder for all other positions.

**8.** Obtain sight picture (using leaf sight or quadrant sight).

**Note.** Leaf sight may be used at ranges between 50 and 250 meters. Quadrant sight ranges are from 50 to 400 meters.

**9.** Adjust the leaf sight if necessary (figure 071-311-2130-4).

---

---

**Performance Steps**

---

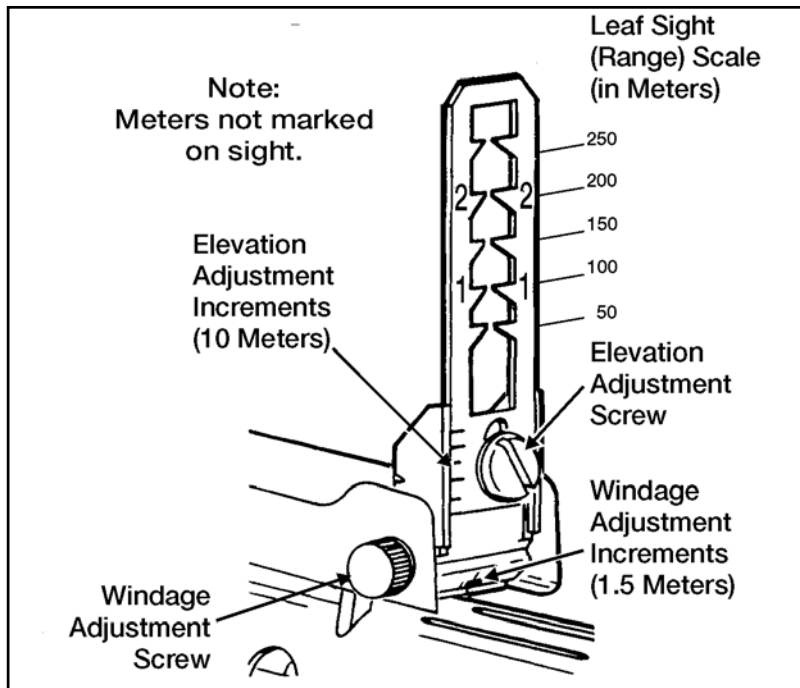


Figure 071-311-2130-4. Leaf sight

**Notes.**

1. For range, the leaf sight scale is marked in 50-meter (165-foot) increments for targets from 50 to 250 meters.

2. For elevation, one increment equals 10 meters (33 feet) at a 200-meter (660-foot) range.

3. For windage, one increment equals 1.5 meters (5 feet) at a 200-meter (660-foot) range.

**a. For headwind and rear wind—**

(1) Loosen the elevation adjustment screw to move the leaf sight up to increase range for head wind.

(2) Lower it to decrease range for rear wind.

(3) Use the rim of a used 40-mm cartridge to turn the elevation adjustment screw.

**b. For left wind and right wind—**

---

---

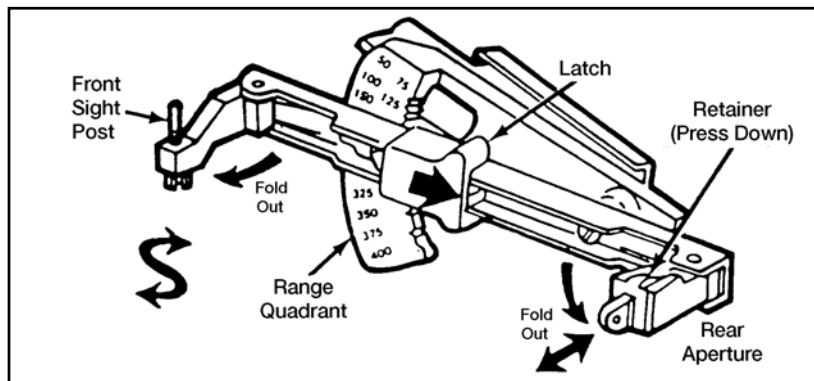
**Performance Steps**

---

(1) Turn the windage adjustment screw clockwise to adjust for wind from the left.

(2) Turn the windage adjustment screw counterclockwise to adjust for wind from the right.

10. Adjust the quadrant sight if necessary (figure 071-311-2130-5).



**Figure 071-311-2130-5. Quadrant sight**

**Note.** Range quadrant is marked in 25-meter (83-foot) increments from 50 to 400 meters (165 to 1,320 feet).

- a. Pull the latch toward you to release the quadrant sight arm.
- b. Select elevation.

**Note.** For elevation adjustment, one notch equals 5 meters (17 feet) at a 200-meter (660-foot) range.

- c. For head wind and rear wind—
  - (1) Turn the front sight post left to increase range for head wind.
  - (2) Turn the front sight post right to decrease range for rear wind.
- d. For left wind and right wind:

(1) Depress the retainer and slide the rear aperture in to adjust for wind from the right.

(2) Slide the rear aperture out to adjust for wind from the left.

**Note.** The vertical line marks the center. One notch equals 1.5 meters (5 feet) at a 200-meter (660-foot) range.

11. Move safety to the FIRE position.

---

---

**Performance Steps**

---

**WARNING**

Be sure there are no obstacles (such as the sling or branches) in the line of fire.

12. Aim and squeeze the trigger to fire.

**Note.** Practice breath control when firing the rifle.

13. If the first round misses, adjust fire as necessary by sensing the impact of the round and manipulating the sight.

**Note.** Continue the adjustment process until a hit is obtained or the area has been covered by fire.

a. If time allows, whether using the AN/PVS-4 or AN/PVS-7, adjust the sights, but if time is critical, adjust the point of aim instead.

b. If the grenade lands more than 25 meters over or short of the target, adjust the range quadrant to bring the next grenade on target.

c. If the grenade explodes less than 25 meters from the target, adjust the point of aim to bring the next grenade on target.

d. If the launcher is properly zeroed, deviation errors will be small and you can easily correct them by adjusting the aiming point. Adjust for wind as described in steps 9 and 10.

---

**Evaluation Preparation:**

*Setup:* At a live-fire M203 range, provide all the materials indicated in the task conditions.

*Brief Soldier:* Tell the soldier to engage targets in his sector of fire at ranges from 50 to 250 meters.

Performance Measures	GO	NO GO
1. Kept the safety in the SAFE position until ready to fire.	___	___
2. Loaded the M203 grenade launcher.	___	___
3. Determined range to target.	___	___
4. Selected the appropriate firing technique based on target range.	___	___
5. Selected firing position.	___	___
6. Adjusted the leaf sight.	___	___

Performance Measures	GO	NO GO
7. Adjusted the quadrant sight.	___	___
8. Moved safety to the FIRE position.	___	___
9. Aimed and squeezed the trigger to fire.	___	___
10. Adjusted fire by sensing the impact of the round and manipulating the sight.	___	___

**Evaluation Guidance:** Score the soldier GO if all performance measures are passed. Score the soldier NO GO if any performance measure is failed. If the soldier scores NO GO, show him what was done wrong and how to do it correctly.

#### References

##### Required

##### Related

FM 23-31

TM 9-1010-221-10

### SUBJECT AREA 17: M4 CARBINE

## 071-100-0003

### Engage Targets with an M4 or M4A1 Carbine

**Conditions:** Given an M4 or M4A1 carbine, magazines, ammunition, individual combat equipment, and stationary or moving targets (personnel or equipment) at engageable ranges.

**Standards:** Detected and determined range to targets. Fired the M4 or M4A1 carbine to engage targets in assigned sector of fire. Applied correct marksmanship fundamentals and target engagement techniques so each target was hit or suppressed.

#### Performance Steps

1. Assume an appropriate firing position based on the situation. The firing position should protect you from enemy fire and observation, yet allow you to place effective fire on targets in your sector of fire.

a. Foxhole. Advantages: best when available. Disadvantages: no overhead cover.



---

**Performance Steps**

---

**b.** Prone. Advantages: steady, easy to assume, low silhouette, and easily adapted to use of cover and support. Disadvantages: effectiveness can be limited by terrain and vegetation irregularities.

**c.** Prone supported. Advantages: steadier than prone, other advantages the same as prone. Disadvantages: same as prone.

**d.** Kneeling. Advantages: used when firing from behind something; used on ground that is level or gently sloping upward. Disadvantage: exposed to small arms fire.

**e.** Kneeling supported. Advantages: steadier than kneeling; other advantages the same as kneeling. Disadvantages: exposed to small arms fire.

**f.** Standing. Advantages: used in assault to surprise targets or when other positions are not appropriate. Disadvantages: exposed to small arms fire.

**2.** Identify targets in your designated sector of fire.

**3.** Determine range to a target.

**a.** Your M4 or MA1 carbine sights can be used to estimate range to targets(s). Viewed through the front sight, a man-sized target appears:

**(1)** Twice the width as the front sight post at about 90 meters.

**(2)** The same width as the front sight post at about 175 meters.

**(3)** Half the width of the front sight post at about 350 meters.

**4.** Load and fire on targets using appropriate engagement techniques.

**a.** Load the weapon.

**b.** Use the appropriate aiming technique.

**(1)** Engage a stationary target using reference points or sighting points.

**(2)** Engage a target moving toward you as you would a stationary target.

**(3)** Engage a target moving laterally, using the single lead technique, by placing the trailing edge of the front sight post at the center of the target. This method causes the lead to increase automatically as the range increases.

**(4)** Engage multiple targets by first firing at the one presenting the greatest danger (usually the closest) and then rapidly proceeding to next target.

**c.** Use the quick-fire technique when there is no time to properly aim. Use this technique on targets within 30 meters of your location. (This technique is most effective in urban terrain or heavy bush.)

---

---

**Performance Steps**

---

- (1) Use the standing position.
  - (2) Use the raised stockwell. Look two or three inches above the sights, on a plane that is level with the barrel.
  - (3) Look at the target, NOT at the sights.
- d. Fire on the targets until they are destroyed or until you receive an order to cease fire.
- 

**Evaluation Preparation:**

*Setup:* On a live-fire range, provide sufficient quantities of equipment and ammunition to support the number of soldiers tested. Have each soldier use his own rifle and magazine.

*Brief Soldier:* Tell soldier he is to detect and engage targets in his sector and, when asked, state the range to the target.

Performance Measures	GO	NO GO
1. Assumed an appropriate firing position based on the situation.	___	___
2. Identified targets in your designated sector of fire.	___	___
3. Determined the range to a target.	___	___
4. Loaded and fired on targets using appropriate engagement techniques.	___	___

**Evaluation Guidance:** Score the soldier GO if all performance measures are passed. Score the soldier NO GO if any performance measure is failed. If the soldier scores NO GO, show him what was done wrong and how to do it correctly.

**References****Required****Related**

FM 21-75

FM 23-9

TM 9-1005-319-10

---

**071-100-0004****Maintain an M4 or M4A1 Carbine**

**Conditions:** Given an M4 or M4A1 carbine, magazine, 5.56-mm ammunition, and small-arms accessory case with the following cleaning materials: clean wiping rags, bore brush, chamber brush, toothbrush,

3-530

071-100-0004

cleaning rod, small-arms swabs, pipe cleaners, cleaner lubricant and preservative (CLP), lubricating oil arctic weather (LAW), and carbine bore cleaner.

**Standards:** Cleaned, inspected, and lubricated the carbine and magazine so they functioned correctly. Cleaned and inspected the ammunition. Turned in any unserviceable ammunition.

---

**Performance Steps**

---

**1. Clear the carbine.**

- a. Remove the magazine from the carbine, if there is one present.
- b. Cock the carbine.
- c. Turn the selector to SAFE.

**Note.** The selector cannot be turned to SAFE unless the carbine is cocked.

**d. Lock the bolt open.**

- (1) Pull the charging handle rearward.
- (2) Press the bottom of the bolt catch.
- (3) Allow the bolt to move forward until it engages the bolt catch.
- (4) Return the charging handle to the forward position.
- (5) Ensure the selector is on SAFE.

e. Check the receiver and chamber to ensure they do not contain ammunition.

**2. Disassemble the carbine.****CAUTION**

Do not use a screwdriver or any other tool when removing the handguards. Doing so may damage the handguards, slip ring, or both.

**WARNING**

Use care not to bend or dent the gas tube while removing handguards.

- a. Remove the sling.
- b. Remove the handguards if you can see dirt or corrosion through the vent holes. Handguards are interchangeable because they are identical.

**CAUTION**

Use only hand pressure to disengage the pivot and takedown pins. Force other than hand pressure may cause damage to the weapon so replacement of the weapon is required. Push the pivot and takedown pins only far enough to disengage the upper receiver from the lower receiver.

c. Push the takedown pin as far as it will go and pivot the upper receiver from the lower receiver.

---

---

**Performance Steps**

---

- d. Push the receiver pivot pin.
- e. Separate the upper and lower receivers.
- f. Pull back the charging handle.
- g. Remove the bolt carrier and bolt.
- h. Remove the charging handle.

**CAUTION**

Do not fully remove the round nuts from the threaded studs. The threaded studs are flared on the end to prohibit removal. However, if the nuts are inadvertently removed, they may be reinstalled.

- i. Remove carrying handle assembly. Loosen the round nuts on the left side of the carrying handle approximately four turns. Loosen the clamping bar from the left side of the upper receiver and lift off the carrying handle.
  - j. Remove the firing pin retaining pin.
  - k. Put the bolt assembly in the locked position by pushing in the bolt.
  - l. Remove the firing pin by allowing it to drop out of the rear of the bolt carrier into your hand.
  - m. Remove the bolt cam pin by turning it one-quarter turn and lifting it out.
  - n. Pull the bolt assembly from the carrier.
- Note.** Perform steps o through q only when the parts are dirty or damaged.
- o. Press the rear of the extractor pin to check spring function. Report any weak springs to unit armorer for replacement.
  - p. Remove the extractor pin by pushing it out with the firing pin (use care not to damage the firing pin).
  - q. Lift out the extractor and spring, taking care that the spring does not separate from the extractor.
  - r. Release the buffer by pressing the buffer and depressing the retainer.
  - s. Remove the buffer and action spring separating the buffer from the spring.
  - t. Extend the buttstock assembly to full open. The M4/M4A1 has a four-position buttstock: closed, 1/2 open, 3/4 open, and full open.
  - u. Grasp the lock lever in the area of the retaining nut, pull downward, and slide the buttstock to the rear to separate the buttstock assembly from the lower receiver extension.

**3. Clean the carbine.**

---

---

**Performance Steps**

---

- a. Upper receiver group.
    - (1) Use small-arms swabs, CLP, and bore brush to clean bore.
    - (2) Use rags, cleaning brush, and CLP to remove powder fouling, corrosion, dirt, and rust from other areas.
    - (3) Clean bolt lugs with CLP and chamber brush.
    - (4) Use CLP and bore brush to clean barrel locking lugs and gas tube.
  - b. Lower receiver group.
    - (1) Remove powder fouling, corrosion, and dirt with rags, cleaning brush, and CLP.
    - (2) Clean buffer tube and buttstock tube with rag attached to holder.
    - (3) Clean buffer action spring and inside lower receiver extension with brush and rags.
  - c. Bolt carrier group.
    - (1) Clean outer and inner surfaces of bolt carrier with rags and CLP.
    - (2) Clean carrier key (use worn bore brush).
    - (3) Clean firing pin recess and firing pin with brush and CLP.
    - (4) Clean firing pin hole with pipe cleaner and CLP.
    - (5) Clean carbon deposits and dirt from locking lugs with cleaning brush and CLP.
    - (6) Clean areas behind bolt ring and under lip of extractor with brush and CLP.
  4. Inspect carbine for serviceability.
    - a. Upper receiver group.
      - (1) Check for free movement of the forward assist assembly.
      - (2) Check for broken or damaged ejection port cover.
      - (3) Check rear sight windage and elevation knob for damage and looseness.
      - (4) Check carrying handle assembly for missing or damaged parts and ensure the handle assembly will mount to the upper receiver.
      - (5) Check front sight assembly for damage.
      - (6) Inspect bore and chamber for pitting or obstructions.
      - (7) Inspect bolt lugs for cracks and burrs.
-

---

### Performance Steps

---

(8) Check for free movement of slip ring.

(9) Check the compensator for proper alignment.

**Note.** The compensator has five slots. The third or middle slot should line up with the front sight post. If not, turn the compensator in for maintenance.

(10) Check the bolt guide rails for chips and burrs.

b. Lower receiver.

(1) Check trigger mechanism for missing or damaged parts.

(2) Check bolt catch for free movement.

(3) Check magazine release button for free movement.

(4) Check buttstock assembly for dents and rust and ensure proper operation of retaining nut and lock-release lever.

(5) Check action spring and buffer for damage.

c. Bolt carrier group.

(1) Check bolt carrier for chips, burrs, and cracks.

(2) Check bolt for cracks or fractures, especially in the cam pin hole area. Bolts that contain pits in the firing pin hole need replacing.

(3) Check firing pin retaining pin for bends and excessive wear.

(4) Check firing pin for bends, cracks, and blunted or sharp end.

(5) Check cam pin for cracks and chips.

(6) Check extractor for chipped or broken edges in the area of the lip that engages the cartridge rim. Check to ensure the rubber insert is inside the extractor spring.

d. Report and turn in unserviceable parts for maintenance.

5. Lubricate the carbine.

**Note.** Under all but the coldest arctic conditions, CLP is the lubricant to use on the carbine. Between +10 degrees Fahrenheit and -10 degrees Fahrenheit, either CLP or LAW can be used. For -35 degrees Fahrenheit or lower, use LAW only.

**Note.** Lightly lube means apply a film of lubricant barely visible to the eye.

**Note.** Generously lube means apply the lubricant heavily enough so it can be spread with the finger.

a. Upper receiver and carrying handle.

(1) Upper receiver. Lightly lube inside of receiver, bore, chamber, locking lugs, outer surfaces of barrel and front sight, and mating surface for carrying handle.

---

---

**Performance Steps**

---

(2) Carrying handle. Apply a drop or two of lubricant to both threaded studs. Lightly lube the clamping bar and both round nuts. Lightly lube the mating surface.

(3) Front sight detent. Depress and apply two or three drops of CLP to front sight detent. Depress several times to work lube into the spring.

(4) Adjustable rear sights. Use one or two drops of CLP. Rotate the following parts to ensure lubricant is spread evenly above and below:

(a) Elevation screw shaft.

(b) Elevation knob.

(c) Windage knob.

(d) Windage screw.

**b. Lower receiver group.**

(1) Lightly lube inside and outside lower receiver extension, buffer, and action spring. Lightly lube inside buttstock assembly. Generously lube buttstock lock-release lever and retaining pin.

(2) Generously lube takedown pin, pivot pin, detents, and all other moving parts and their pins.

**c. Bolt carrier group.**

(1) Lightly lube charging handle and inner and outer surfaces of bolt carrier.

(2) Place one drop of CLP in the carrier key.

(3) Apply a light coat of CLP on firing pin and firing pin recess in bolt.

(4) Generously lube outside the bolt body, bolt rings, and cam pin area.

(5) Apply a light coat of CLP on extractor and pin.

**6. Assemble the carbine.**

**a.** Install buttstock assembly. Align the buttstock assembly with lower receiver extension; pull downward on the lock release lever near the retaining pin, and slide the buttstock assembly onto the lower receiver extension.

**b.** Insert action spring and buffer.

**c.** Insert extractor and spring.

**d.** Push in extractor pin.

**e.** Slide bolt into carrier.

---

---

**Performance Steps**

---

**WARNING**

Be sure the cam pin is installed in the bolt group. If it is not, the carbine can still fire and will explode.

- f. Replace bolt cam pin.
- g. Drop in and seat firing pin.
- h. Pull bolt back.
- i. Replace retaining pin.
- j. Engage, then push charging handle in part of the way.

**WARNING**

Do not exchange or switch bolt assemblies from one M4 or M4A1 to another.

- k. Slide in bolt carrier group.
  - l. Push in charging handle and bolt carrier group together.
  - m. Join upper and lower receivers.
  - n. Engage receiver pivot pin.
  - o. Close upper and lower receiver groups. Push in takedown pin.
  - p. Replace handguards.
  - q. Replace sling.
7. Perform a function check on the M4 or M4A1 carbine to determine correct functioning according to Task 071-100-0005.
8. Maintain M16/M4 magazine and ammunition.
- a. Maintain magazine.
    - (1) Disassemble magazine.
      - Insert the nose of a cartridge into the hole in the base of the magazine and raise the rear of the magazine until the indentation on the base is clear of the magazine.
      - Slide the base forward until free of the tabs.
      - Remove the magazine spring and follower (do not separate).
    - (2) Clean all parts using a rag soaked with CLP. Dry all parts.
    - (3) Inspect parts for damage such as dents and corrosion. If any damage is found, turn in to maintenance.
    - (4) Lubricate the magazine. Lightly lube the spring only.
-



---

**Performance Steps**

---

**(5) Assemble the magazine.**

- Insert the follower and spring in the magazine tube and jiggle the spring to seat them in the magazine.

- Slide the base under all four tabs until it is fully seated.

Make sure the printing is on the outside.

**b. Maintain ammunition.****(1) Clean ammunition with a clean dry rag.****(2) Inspect and turn in any ammunition with the following defects:** corrosion, dented cartridges, cartridges with loose bullets, and cartridges with the bullet pushed in.

---

**Evaluation Preparation:**

*Setup:* Have soldiers use their own weapons and magazines. Provide swabs, cleaner, lubricant, preservative (CLP), pipe cleaners, lubricating oil, and rifle bore cleaner (the soldier should not select rifle bore cleaner for use). Also provide several rounds of dummy ammunition, if available.

*Brief Soldier:* Tell the soldier to clean, inspect, and lubricate the weapon and magazine following normal safety practices.

Performance Measures	GO	NO GO
1. Cleared the carbine.	___	___
2. Disassembled the carbine.	___	___
3. Cleaned the weapon using the correct materials.	___	___
4. Inspected for unserviceable parts.	___	___
5. Assembled the carbine.	___	___
6. Performed a function check.	___	___
7. Disassembled the magazine.	___	___
8. Cleaned the magazine.	___	___
9. Assembled the magazine	___	___
10. Cleaned the ammunition.	___	___

**Evaluation Guidance:** Score the soldier GO if all performance measures are passed. Score the soldier NO GO if any performance measure is failed.

If the soldier scores NO GO, show him what was done wrong and how to do it correctly.

#### References

##### Required

##### Related

TM 9-1005-319-10

### SUBJECT AREA 18: 9MM PISTOL

---

## 071-004-0001

### Maintain an M9 Pistol

**Conditions:** Given an M9 pistol with components (M12 or M7 holster, magazine, and ammunition pocket), 9-mm ammunition, cleaner lubricant preservative (CLP), lubricating oil arctic weather (LAW), lubricating oil semifluid (LSA), bore brush, wiping rags, M4 cleaning rod (a one-section handle and a swab holder), and small-arms cleaning swabs.

**Standards:** Cleaned and lubricated M9 pistol and magazine; inspected parts, turned in unserviceable parts for maintenance, assembled pistol, ensured pistol was operational, cleaned and inspected ammunition for serviceability, and turned in unserviceable ammunition.

---

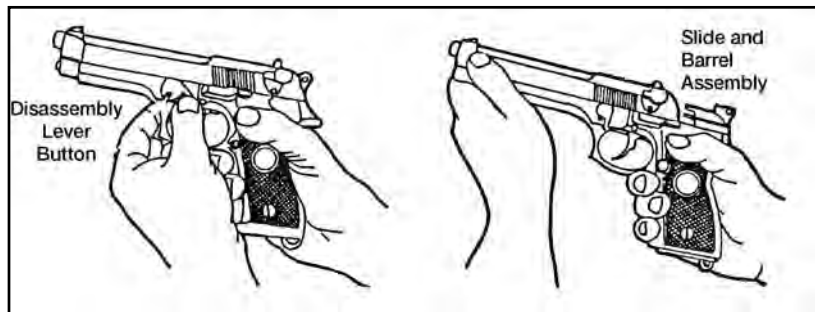
#### Performance Steps

1. Clear the pistol.
    - a. Place the safety lever in the SAFE position.
    - b. Hold the pistol in the raised pistol position.
    - c. Depress the magazine release button; remove the magazine from the pistol.
    - d. Pull the slide to the rear; remove any chambered round.
    - e. Push the slide stop up, locking the slide to the rear.
    - f. Look into the chamber to ensure it is empty.
  2. Disassemble the pistol and magazine.
    - a. Depress the slide stop and let the slide go forward.
    - b. With your right hand, hold the pistol with the muzzle slightly raised.
    - c. With your forefinger, press the disassembly lever button (figure 071-004-0001-1).
-

---

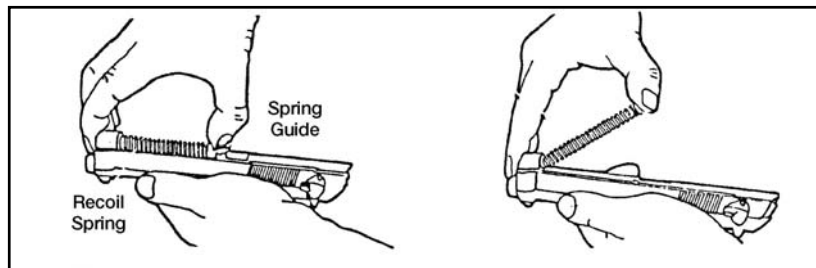
**Performance Steps**

---



**Figure 071-004-0001-1. Disassembly lever button**

- d. Rotate the disassembly lever downward until it stops.
- e. Pull the slide and barrel assembly forward (figure 071-004-0001-1), and remove it from the receiver.
- f. Slightly compress the recoil spring and spring guide. At the same time, lift them up and remove them, allowing the recoil spring to stretch slowly (figure 071-004-0001-2).



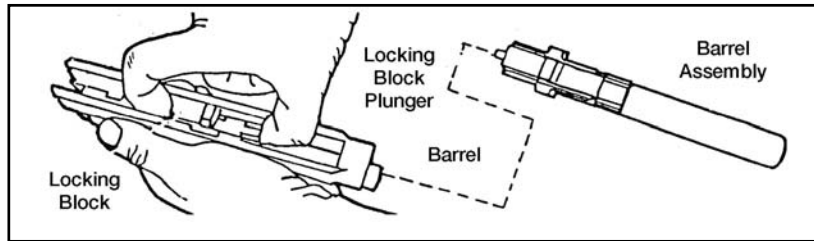
**Figure 071-004-0001-2. Removal of the recoil spring and spring guide**

- g. Separate the recoil spring from the spring guide.
  - h. Push in on the locking block plunger while pushing the barrel forward slightly. Lift and remove the locking block and barrel assembly from the slide (figure 071-004-0001-3).
-

---

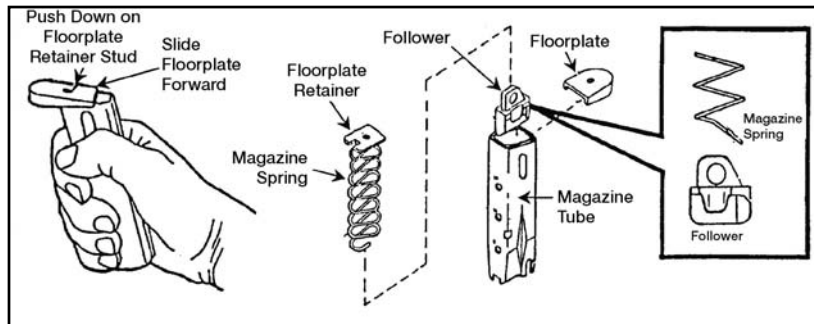
**Performance Steps**

---



**Figure 071-004-0001-3. Removal of the locking block and barrel assembly**

i. Disassemble the magazine (figure 071-004-0001-4).



**Figure 071-004-0001-4. Disassembly of the magazine**

- (1) Grasp the magazine firmly, with the floor plate up and the back of the magazine tube against the palm of your hand.
  - (2) Depress the locking block to make the locking block plunger protrude.
  - (3) Using the locking block plunger, push down on the floor plate retainer stud.
  - (4) Slide the floor plate slightly forward with your thumb.
  - (5) While removing the floor plate, use your thumb to keep pressure on the magazine spring.
  - (6) Remove the floor plate retainer, the magazine spring, and the follower from the magazine tube.
  - (7) Remove the magazine spring from the follower.
  - (8) Remove the floor plate retainer from the magazine spring.
- 3. Clean the pistol and magazine.**
-

---

**Performance Steps**

---

**CAUTION**

Use the bore brush to clean only the bore. Using it on any other part of the pistol will cause damage.

- a. Slide assembly.
    - (1) Clean slide assembly with a cloth. Use CLP on a soft brush to remove excess dirt and carbon.
    - (2) Wipe the slide assembly dry with a clean cloth.
  - b. Barrel assembly.
    - (1) Attach a bore brush to a cleaning rod. Moisten the bore brush with CLP and insert it into the chamber end of the barrel. Make sure the brush completely clears the muzzle before you pull it back through the bore. Repeat this procedure several times to loosen carbon deposits.
    - (2) To clean and dry the barrel, push a clean swab through the bore. Repeat as necessary with fresh swabs until a swab comes out clean.
    - (3) Clean locking block with a soft brush.
    - (4) Clean the recoil spring and spring guide with CLP and, if needed, a soft brush or cloth.
  - c. Receiver assembly. Wipe the receiver assembly clean with a cloth and, if needed, a soft brush.
  - d. Magazine (figure 071-004-0001-4).
    - (1) Wipe the magazine tube and the follower with CLP, a cloth, and a soft brush.
    - (2) Clean the magazine spring, floor plate retainer, and floor plate with a clean cloth.
  - e. Holster. Remove dirt from exterior with stiff brush. Wipe interior with clean cloth.
  - f. Ammunition. If ammunition gets wet or dirty, clean it and remove corrosion from it at once using a dry cloth.
4. Inspect for serviceability.
    - a. Slide assembly.
      - (1) Check to ensure the ambidextrous safety moves freely.
      - (2) Check the firing block for damage.
      - (3) Check the rear sight for looseness.
    - b. Barrel assembly.
      - (1) Inspect the bore and chamber for pitting or obstructions.
-

---

**Performance Steps**

---

(2) Check the locking block plunger to ensure the locking block moves freely.

(3) Inspect the locking lugs for cracks and burrs.

c. Recoil spring and recoil spring guide.

(1) Check recoil spring to ensure it is not bent or damaged.

(2) Check recoil spring to ensure it is straight and free of cracks and burrs.

d. Receiver assembly.

(1) Check for bends, chips, and cracks.

(2) Check to ensure the slide stop and magazine stop move freely.

(3) Check the guide rails for excessive wear, burr, cracks, or chips.

e. Magazine assembly (figure 071-004-0001-4).

(1) Check for damage to the spring and follower.

(2) Inspect magazine lips to ensure they are not bent excessively and that they have no cracks and burrs.

(3) Check to ensure the magazine tube is not bent.

f. Ammunition.

(1) Check for damaged or corroded ammunition. Turn in heavily corroded or damaged ammunition.

(2) Check to ensure ammunition is free of oil and grease.

5. Lubricate the pistol and magazine.

**Note.** CLP, LSA, and LAW are the only lubricants authorized for this pistol.

**Note.** You can use CLP and LSA interchangeably.

**Note.** Before firing, remove excess lubricant from the bore.

a. Lubricate all parts with a light coat of LSA or CLP at temperatures above -10 degrees Fahrenheit, or LAW at temperatures below +10 degrees Fahrenheit.

b. Do not mix LAW with other lubricants.

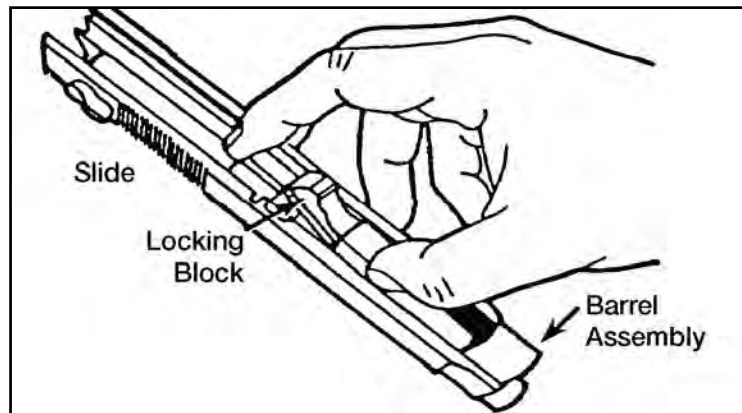
6. Assemble the pistol.

---

---

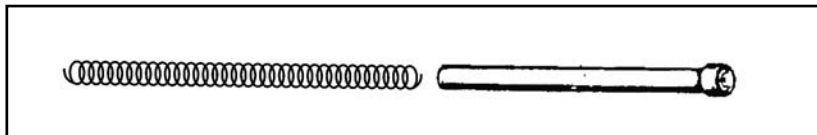
**Performance Steps**

---



**Figure 071-004-0001-5. Insertion of the barrel assembly**

- a. Grasp the slide with the bottom facing up (figure 071-004-0001-5).
- b. With the other hand, grasp the barrel assembly with the locking block facing up.
- c. Insert the muzzle into the forward end of the slide. At the same time, lower the rear of the barrel assembly by moving the barrel slightly downward with light thumb pressure. The barrel will fall into place.
- d. Insert the recoil spring guide into the recoil spring (figure 071-004-0001-6).



**Figure 071-004-0001-6. Recoil spring and spring guide**

- e. Insert the end of the recoil spring and the recoil spring guide into the recoil spring housing. At the same time, compress the recoil spring and lower the spring guide until it is fully seated on the locking block cutaway (figure 071-004-0001-7).
-

---

### Performance Steps

---

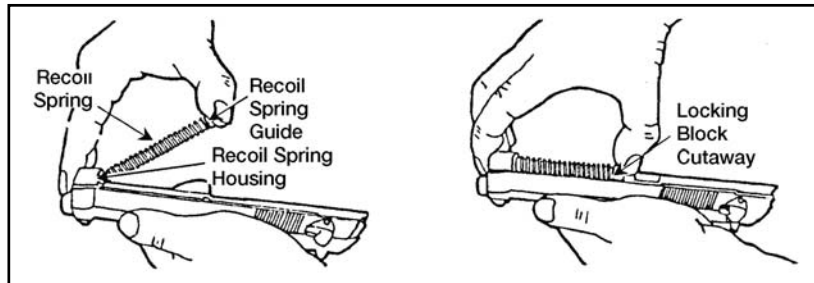


Figure 071-004-0001-7. Insertion of the recoil spring and guide

**CAUTION**

Be sure that the hammer is uncocked and firing pin block lever is in the down position. If the hammer is cocked, *manually and carefully* lower the hammer. Do not pull the trigger while placing the slide onto the receiver.

f. Push the firing pin block lever down. Grasp the slide and barrel assembly with the sights up, and align the slide on the receiver assembly guide rails (figure 071-004-0001-8).

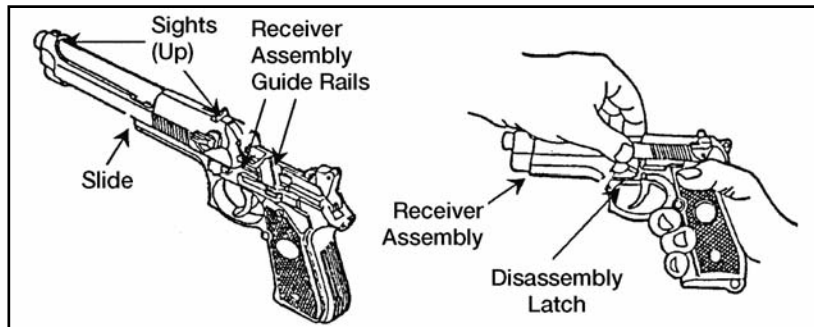


Figure 071-004-0001-8. Final assembly

g. Push until the rear of the slide is a short distance beyond the rear of the receiver assembly and hold. At the same time, rotate the disassembly latch upward. A click indicates a positive lock (figure 071-004-0001-8).

h. Assemble the magazine.

(1) Insert the follower into the top coil of the magazine spring. Make sure the notches on the follower and magazine tube are on the same side.

---



---

**Performance Steps**

---

(2) Insert the magazine spring with follower into magazine tube.

(3) Turn the magazine bottom up, with its back against the palm of the hand. Attach and center the floor plate retainer on the bottom spring coil.

**CAUTION**

After inserting the magazine spring, keep tension on it with your thumb. Be careful not to place the lips of the magazine tube on a hard surface while you reassemble the magazine.

(4) Push and hold the magazine spring and floor plate retainer down. At the same time, slide the floor plate over the sidewalls until it seats fully.

(5) Carefully insert the magazine into the pistol well. You will hear a click when it locks into position.

**WARNING**

Make sure the pistol is clear and unloaded.

7. Perform a function check.

**Evaluation Preparation:**

*Setup:* At the test site, provide a field table with all the equipment given in the task conditions.

*Brief Soldier:* Tell the soldier to clear, disassemble, clean, inspect, lubricate, assemble, and perform a function check on the weapon.

Performance Measures	GO	NO GO
1. Cleared the pistol.	___	___
2. Disassembled the pistol and magazine without damaging any parts.	___	___
3. Cleaned the pistol, components, and ammunition.	___	___
4. Inspected the pistol, components, and ammunition for defects.	___	___
5. Lubricated the pistol and magazine correctly.	___	___
6. Assembled the pistol and magazine in correct sequence.	___	___
7. Performed a function check.	___	___

**Evaluation Guidance:** Score the soldier GO if all performance measures are passed. Score the soldier NO GO if any performance measure is failed. If the soldier scores NO GO, show him what was done wrong and how to do it correctly.

**References**

**Required**

**Related**

TM 9-1005-317-10

---

**071-004-0003**

**Load an M9 Pistol**

**Conditions:** Given an unloaded M9 pistol and a separate magazine loaded with M9 ammunition.

**Standards:** Correctly loaded the magazine and ammunition into the pistol; ensured safety lever was in the safe position.

---

**Performance Steps**

**WARNING**

The M9 pistol has single- and double-action firing modes. When the safety is set to FIRE, squeezing the trigger will automatically cock and fire the pistol (this is the double-action mode).

Keep your finger away from the trigger until you intend to fire.

1. Place safety lever in SAFE position.
2. Insert the loaded magazine into the pistol magazine well until you hear a click when the magazine seats fully.
3. Point the pistol in a safe direction (usually at the target or skyward).
4. Retract the slide fully and release it. This strips a cartridge from the magazine and chambers it.

---

**Evaluation Preparation:**

*Setup:* At the test site, provide the equipment listed in the task conditions . Use dummy rounds to evaluate this task.

*Brief Soldier:* Tell the soldier to load the M9 pistol so it will fire a round when he squeezes the trigger.

Performance Measures	GO	NO GO
1. Placed the safety lever in SAFE position.	___	___
2. Inserted the loaded magazine into the magazine well.	___	___

Performance Measures	GO	NO GO
3. Pointed the pistol in a safe direction (usually at the target or skyward).	—	—
4. Retracted and released the slide to chamber a cartridge from the magazine.	—	—

**Evaluation Guidance:** Score the soldier GO if all performance measures are passed. Score the soldier NO GO if any performance measure is failed. If the soldier scores NO GO, show him what was done wrong and how to do it correctly.

#### References

##### Required

##### Related

TM 9-1005-317-10

---

## 071-004-0004

### Unload an M9 Pistol

**Conditions:** Given an M9 pistol loaded with rounds.

**Standards:** Correctly removed magazine and ammunition from the pistol; removed all the rounds from the magazine; and ensured the pistol safety lever was in the SAFE position.

---

#### Performance Steps

#### WARNING

The M9 pistol will fire single- or double-action mode. With the safety in the FIRE position, squeezing the trigger automatically cocks and fires the pistol. This is the double-action mode of firing the pistol. Keep your finger away from the trigger unless you intend to fire.

1. Remove the magazine and the ammunition from the pistol.
  - a. Place the safety lever in the SAFE position.
  - b. Depress the magazine release button, and remove the magazine from the pistol.
  - c. Point the pistol in a safe direction (usually at the target or skyward).
  - d. Retract the slide fully to remove the chambered cartridge.
  - e. Lock the slide to the rear using the slide stop. Visually inspect the chamber to make sure it is empty.
  - f. Release the slide. Ensure the safety lever is in the SAFE position.

---

**Performance Steps**

---

2. Remove the ammunition from the magazine.

a. With one hand, hold the magazine upright, front end forward. With your thumb, firmly press down on the cartridge rim, and push forward. As the cartridge moves forward, tip the forward end of it up and out with your index finger.

b. Repeat the above steps until the magazine is empty.

---

**Evaluation Preparation:**

*Setup:* At the test site, provide the equipment listed in the task conditions. You can use dummy rounds to evaluate this task.

*Brief Soldier:* Tell the soldier to unload the M9 pistol and remove all ammunition from the magazine.

Performance Measures	GO	NO GO
1. Removed magazine and ammunition from the pistol.	___	___
2. Removed ammunition from magazine.	___	___

**Evaluation Guidance:** Score the soldier GO if all performance measures are passed. Score the soldier NO GO if any performance measure is failed. If the soldier scores NO GO, show him what was done wrong and how to do it correctly.

**References**

**Required**

**Related**

TM 9-1005-317-10

---

**071-004-0006****Engage Targets with an M9 Pistol**

**Conditions:** Given an M9 pistol and one or more magazines loaded with 9-mm ammunition.

**Standards:** Applied the correct M9 target engagement techniques, and engaged hostile targets.

---

**Performance Steps**

---

1. Identify the target(s). The most likely target you will engage is an enemy soldier on foot.

2. Apply the fundamentals of quick fire.

---

---

**Performance Steps**

---

**Note.** To fire quickly without using the pistol sights, use the pistol as an extension of your arm.

- a. To use the pistol grip, hold the pistol in your nonfiring hand. Form a "V" with the thumb and forefinger of your firing hand.
- b. Place the pistol in the "V," with the sights in line with your firing arm.
- c. Hold your upper arm close to your body, and your forearm at about a 45-degree angle.
- d. Wrap your lower three fingers around the grip, putting equal pressure to the rear with all three fingers (figure 071-004-0006-1).
- e. Place your thumb alongside the pistol without applying any pressure.
- f. Place your trigger finger on the trigger so it can be pulled to the rear.
- g. Tightly grip the pistol until your hand begins to tremble. Relax until the trembling stops. At this point, you have applied the necessary pressure for a solid grip.



**Figure 071-004-0006-1. Pistol ready position, one-hand grip**

**Note.** If you relax any of your three fingers on the grip, you must reapply the entire grip.

---

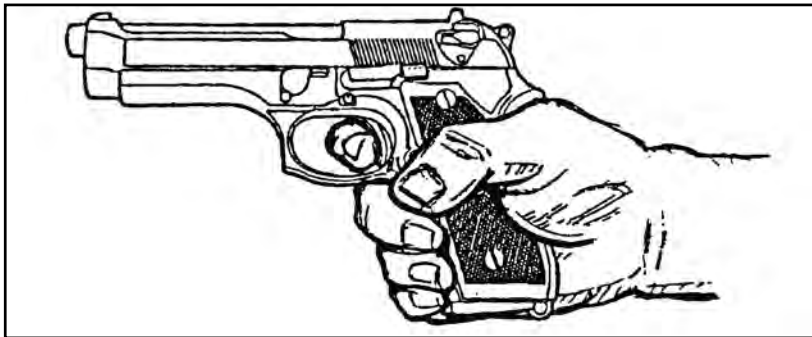
---

**Performance Steps**

---

**3. Choose one of the following supported or unsupported grips:**

**a. Supported grip.** The only supported grip is the one-hand grip (figure 071-004-0006-2). Begin by gripping the weapon as previously described (step 2). Allow the thumb of your firing hand to rest without pressure beside your weapon. Place your trigger finger, between the tip and the second joint, on the trigger, so you can squeeze the trigger to the rear. Your trigger finger must work independently of your other fingers.



**Figure 071-004-0006-2. One-hand grip**

**b. Unsupported grips.** You may use any of three nonfiring hand grips to support your firing hand (figure 071-004-0006-3, figure 071-004-0006-4, and figure 071-004-0006-5).

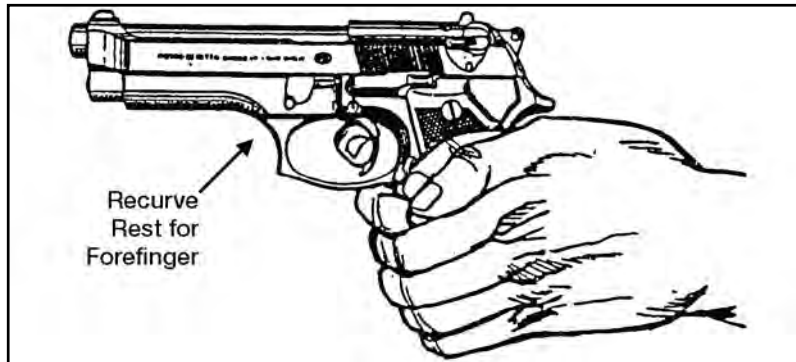
**(1) Fist grip** (figure 071-004-0006-3). Begin by gripping the weapon as previously described (step 2). Firmly close the fingers of your nonfiring hand over the fingers of your firing hand. Make sure the index finger of your nonfiring hand is between the middle finger of your firing hand and the guard. Place your nonfiring thumb beside your firing thumb.

---

---

**Performance Steps**

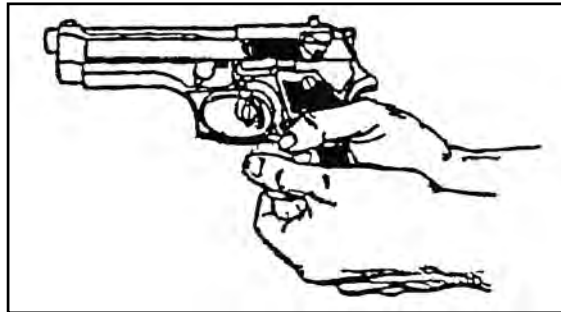
---



**Figure 071-004-0006-3. Fist grip**

**Note.** The M9 pistol has a recurved trigger guard, which allows you to place the index finger of your nonfiring hand on the front of the trigger guard if you wish.

(2) Palm-supported grip (figure 071-004-0006-4). Begin by gripping the weapon as previously described (step 2). Place your nonfiring hand under your firing hand. Wrap your nonfiring fingers around the back of your firing hand. Place your nonfiring thumb over the middle finger of your firing hand.



**Figure 071-004-0006-4. Palm-supported grip**

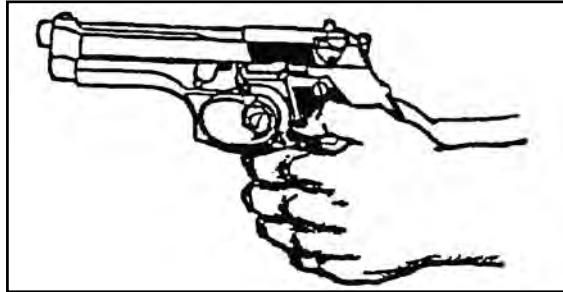
(3) Weaver grip (figure 071-004-0006-5). Apply this grip the same as the fist grip, but wrap your nonfiring thumb over your firing thumb.

---

---

**Performance Steps**

---



**Figure 071-004-0006-5. Weaver grip**

**4.** Select the most stable firing position with the best cover. Consider the following positions:

**a.** Prone (figure 071-004-0006-6). To assume the prone position—

**(1)** Lie flat on the ground, facing the target.

**(2)** Extend your arms to the front, with your firing arm locked.

**(3)** Wrap your nonfiring hand around either the wrist or the fingers of your firing hand.

**(4)** Face forward. Keep your head down between your arms and behind the weapon.



**Figure 071-004-0006-6. Prone position**

**b.** Standing-with-support (figure 071-004-0006-7). To assume this position--

**(1)** Use available cover for support. For example, stand behind a tree or wall.

**(2)** Stand behind a barricade, with your firing side in line with the edge of the barricade.

---



---

**Performance Steps**

---

(3) Place the palm of your nonfiring hand at eye level on the edge of the barricade, and extend your thumb past the edge of the barricade.

(4) Lock the elbow of your firing arm. Rest your forearm on the extended thumb of your nonfiring hand.

(5) Move the foot on your nonfiring side forward until your toe touches the bottom of the barricade.

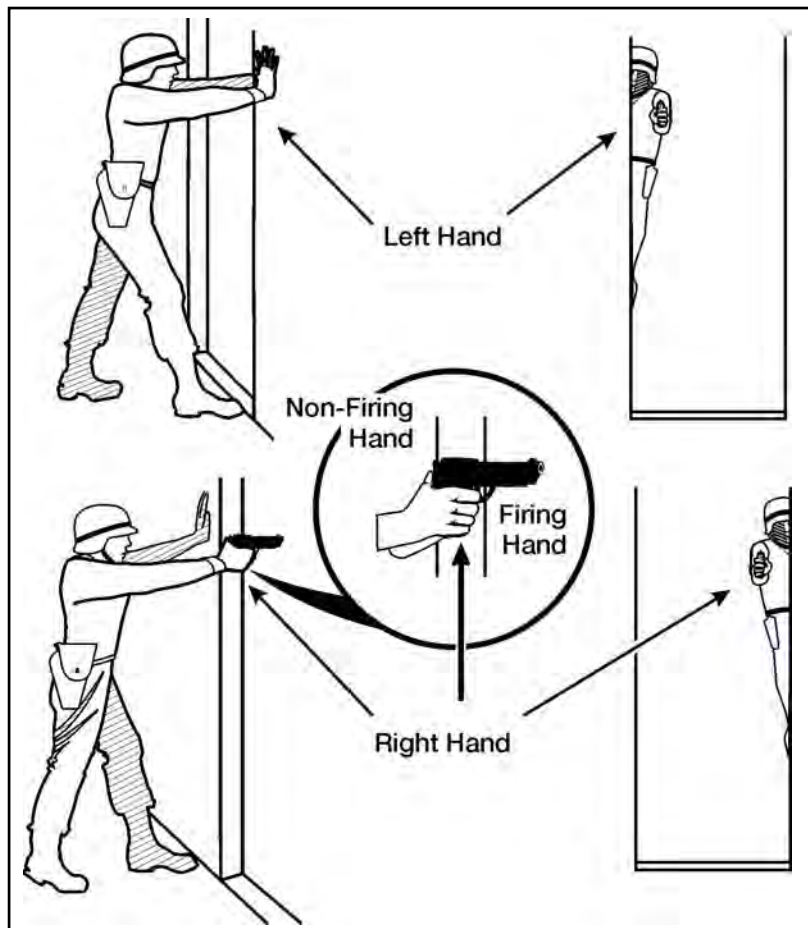


Figure 071-004-0006-7. Standing-with-support position

---

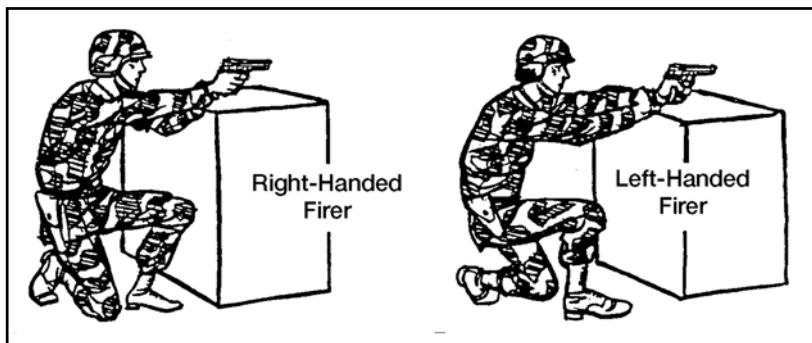
---

**Performance Steps**

---

c. Kneeling (figure 071-004-0006-8). To assume this position—

- (1) Use available cover, such as a low wall, rocks, or a vehicle that you can fire over, for support.
- (2) Place your firing knee on the ground. Put your left knee down to fire left-handed, or your right knee down to fire right-handed.
- (3) Bend your other knee. Place the foot on your nonfiring side flat on the ground, pointing toward the target. Extend your arms over available cover and use it for support.
- (4) Lock the wrist and elbow of your firing arm.
- (5) Wrap your nonfiring hand around your firing fist or wrist to support your firing arm.



**Figure 071-004-0006-8. Kneeling position**

**Note.** This position could silhouette you, making you a better target. When possible, fire around the sides of walls, rocks, or vehicles instead of over them.

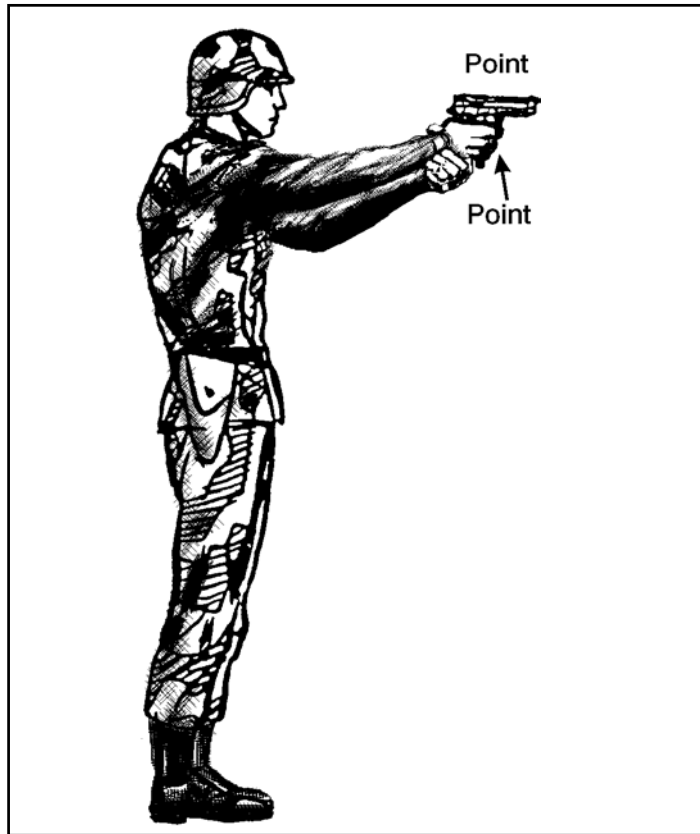
d. Standing-without-support (figure 071-004-0006-9). To assume this position—

- (1) Face the target.
  - (2) Place your feet a comfortable distance apart.
  - (3) Wrap your nonfiring hand around the fist or wrist of your firing hand. Lock the wrist and elbow of your firing arm toward the target.
  - (4) Keep your body straight.
-

---

Performance Steps

---



**Figure 071-004-0006-9. Standing-without-support position**

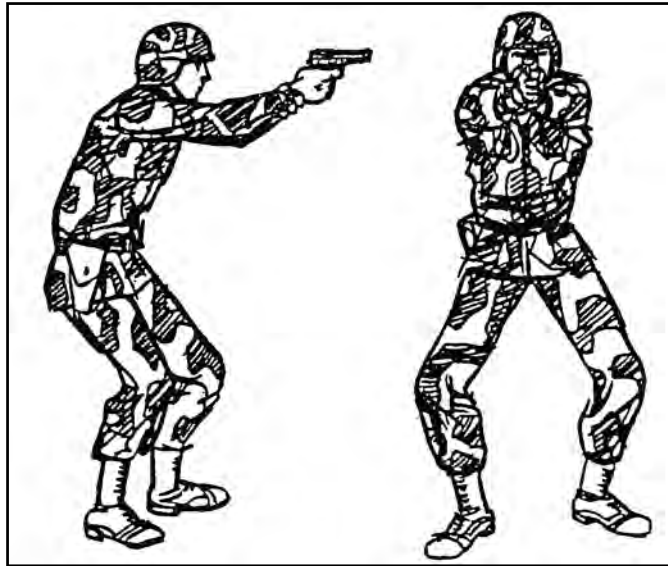
e. Crouching (figure 071-004-0006-10). This position is the same as the standing-without-support position, except you must bend your knees slightly. Balance by leaning forward at the waist.

---

---

**Performance Steps**

---



**Figure 071-004-0006-10. Crouching position**

5. Apply the fundamentals of marksmanship.
  - a. Pistol grip. To obtain a proper pistol grip—
    - (1) Place the pistol in the "V" formed by the thumb and forefinger of your firing hand. Line the sights up with your firing arm. Wrap your lower three fingers around the pistol. Grip with your middle finger under the trigger guard. Exert equal pressure on all three lower fingers to the rear, back through the wrist and forearm (figure 071-004-0006-1).
    - (2) Rest your thumb on top of your middle finger when gripping the pistol. Do not exert any downward pressure.
    - (3) Grip the pistol firmly, but not so firmly that your hand trembles.
  - b. Sight alignment. To sight properly—
    - (1) Align the front sight blade in the rear sight notch so an equal amount of light shows on either side of the front sight. Ensure the top of the front and rear sights are even.
    - (2) Relax as much as possible.
    - (3) Maintain the correct sight alignment, and focus on the front sight.

---

**Performance Steps**

---

(4) Squeeze the trigger with a steadily increasing pressure straight to the rear, taking care not to disturb the sight alignment until after the hammer falls.

**Note.** When there is more than one target, choose the target that is the greatest danger. This is often the closest target.

---

**Evaluation Preparation:**

*Setup:* Evaluate this task during daylight on a 9-mm combat pistol qualification course. Provide the soldier with 8 magazines and 52 rounds of live ammunition.

*Brief Soldier:* Tell the soldier to use his own pistol. Tell the soldier he must hit 25 of the 30 targets using correct engagement techniques.

Performance Measures	GO	NO GO
1. Assumed the firing positions:	___	___
a. Assumed the prone position.		
b. Assumed the standing-with-support position.		
c. Assumed the standing-without-support position.		
d. Assumed the kneeling position.		
e. Assumed the crouching position.		
2. Applied the fundamentals of marksmanship.	___	___
3. Engaged the targets:	___	___
a. From the prone position.		
b. From the standing-with-support position.		
c. From the standing-without-support position.		
d. From the kneeling position.		
e. From the crouching position.		

**Evaluation Guidance:** Score the soldier GO if all performance measures are passed. Score the soldier NO GO if any performance measure is failed. If the soldier scores NO GO, show him what was done wrong and how to do it correctly.

**References****Required****Related**

FM 23-35

TM 9-1005-317-10

071-004-0006

3-557

SUBJECT AREA 19: CROWD CONTROL

**191-376-4121**

**Use a Riot Baton**

**Conditions:** You are a member of a riot control formation and must position yourself in a crowd control situation. You are given a riot baton, a flak vest, shin guards, and a helmet with a face shield.

**Standards:** Perform all necessary steps to use the riot baton properly and position yourself to defend against individuals in a crowd. Observe all safety precautions.

**Performance Steps**

1. Grip the riot baton.
  - a. Put the thong over the right thumb as shown in Figure 191-376-4121-1 and bring it around so the thong wraps over the back of the hand as shown in Figure 191-376-4121-2. This is called the baton thong position.



Figure 191-376-4121-1. Baton thong position, Graphic 1

---

**Performance Steps**

---



**Figure 191-376-4121-2. Baton thong position, Graphic 2**

**b.** Rotate your right hand over and onto the baton handle and grasp it about six inches from the end. The thong will be pressed against the back of the hand as shown in Figure 191-376-4121-3. This is called the right-hand grip.



**Figure 191-376-4121-3. Right-Hand Grip**

**Note.** This gives you a secure grip and allows for a quick release of the weapon when the hand is relaxed.

- 2.** Assume the parade rest position.
    - a.** Place your feet a comfortable distance (about shoulder width) apart.
    - b.** Grip the baton in the right hand and allow your right arm to hang naturally.
    - c.** Hold the baton horizontally across your body.
-

---

**Performance Steps**

---

d. Grasp the baton with your left hand, palm facing out and away from the body and about six inches from the end of the baton as shown in Figure 191-376-4121-4.



**Figure 191-376-4121-4. Parade rest position**

3. Assume the port position. This is a ready position for individual defensive tactics.

**Note.** Assemble and move to all formations in the port position.

---



---

**Performance Steps**

---

- a. Lift the left end of the baton up by bending your left elbow while in the parade rest position. Your left hand should be level with your left shoulder.
- b. Ensure that the striking end of the baton bisects the angle between the neck and the left shoulder.
- c. Hold the baton about 8 inches from the body as shown in Figure 191-376-4121-5. This is the port position.



**Figure 191-376-4121-5. Port position**

4. Assume the on-guard position.

**Note.** This is a ready position used in making initial contact with rioters. Do not hold it for long periods because it is tiring to the body. Protective movements are normally executed from this position.

- a. Stand with your feet apart, left foot forward. Bend your knees slightly and lean forward.
-

---

**Performance Steps**

---

- b.** Hold the baton against your hip with your right hand.
  - c.** Hold your left forearm horizontally across your body with your palm up and at a level that will protect your throat area.
  - d.** With your left hand, grasp the baton about 6 inches from the end.
- Figure 191-376-4121-6 and figure 191-376-4121-7 show the guard position from the front and side.



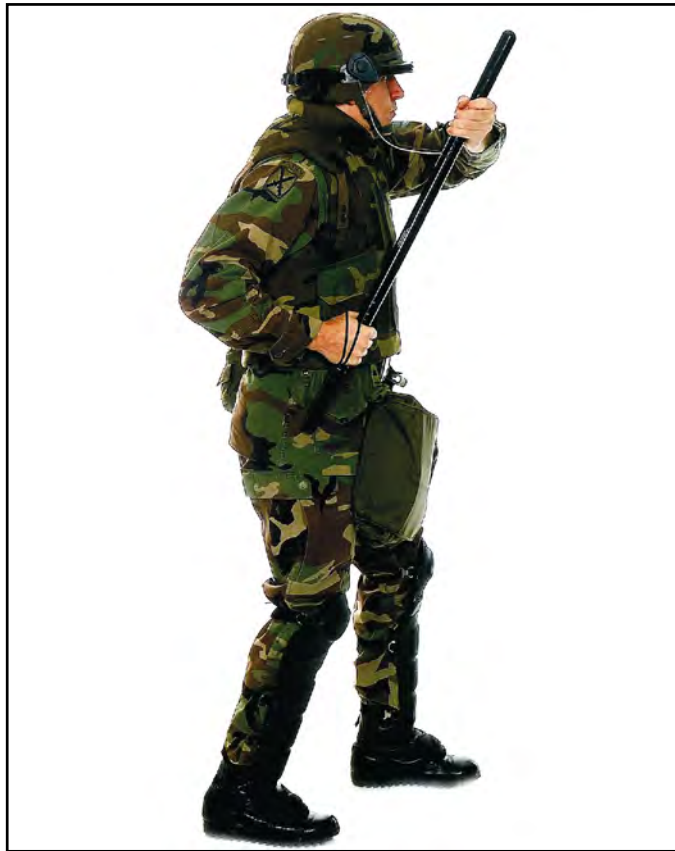
**Figure 191-376-4121-6. On-guard position (front view)**

---

---

**Performance Steps**

---



**Figure 191-376-4121-7 On-guard position (side view)**

- 5.** Ensure that a blow is not directed to one of the five fatal points. Refer to Figure 191-376-4121-8.
-

---

## Performance Steps

---



Figure 191-376-4121-8 Five fatal points of impact

### WARNING

Never direct a blow to any of the five fatal points of impact on the human body. These are the head, the side of the neck or throat, the chest cavity (heart area), and the armpit. Deliver blows only to vulnerable parts of your opponent's body, such as the shoulder.

6. Perform the short-thrust offensive technique from the on-guard position.
  - a. Take one rapid step forward with the left foot.
  - b. Snap your left arm straight and push your right hand to drive the striking end of the baton into a vulnerable point on the opponent's body.
  - c. Return to the on-guard position.
7. Perform the long-thrust offensive technique from the on-guard position.

---

**Performance Steps**

---

- a. Hold the baton in your right hand, take one rapid step forward with your right foot, and simultaneously release the left-hand grip.
    - b. Snap the baton forward by rapidly extending your right arm, driving the striking end of the weapon into a vulnerable point of the opponent's body.
    - c. Return to the on-guard position.
  8. Perform the butt-stroke offensive technique from the on-guard position.
    - a. Raise the right hand (while keeping the left hand level with the left shoulder) until the baton is almost parallel to the ground.
    - b. Advance the body rapidly by moving the right foot forward one step.
    - c. Snap the right arm straight forward by sliding the right hand up the baton until the thong is tight across the back of the hand.
    - d. Drive the butt end of the baton to the left, striking the opponent's shoulder.
    - e. Return to the on-guard position.
  9. Perform the baton smash offensive technique from the parade rest, port, or on-guard position.
    - a. Hold the baton at chest level, horizontal to the ground.
    - b. Advance the left foot rapidly and snap both arms straight.
    - c. Smash the length of the baton across the opponent's chest.
    - d. Return to the position.
  10. Defend yourself against a blow to the head.

**Note.** All the defensive tactics are started from the parade rest, port, or on-guard position.

    - a. Assume either the parade rest, port, or on-guard position.
    - b. Snap your left hand to the left side of your body and your right hand up and to the left.
    - c. Block an attacker's blow and immediately snap both arms up so the left hand is near the left shoulder and the right hand is in front of the left shoulder.
    - d. Execute a jab or smash by stepping forward with your right foot, driving your body forward. Jab the thong end of the baton into the attacker's upper body.
    - e. Return to the original starting position.
  11. Defend yourself against a backhand blow.
    - a. Assume either the parade rest, port, or on-guard position.
-

---

**Performance Steps**

---

- b.** Snap both arms out and to your right or left front, depending on the direction of the oncoming blow.
  - c.** Raise your left hand above your head so the grip end of the baton is pointing down.
  - d.** Block the attacker's blow.
  - e.** After blocking the blow, bring the right hand up near the right shoulder.
  - f.** Move the left hand down, parallel to the chest area, in preparation for a butt stroke. (Refer to step 8).
- 12.** Defend yourself against a long thrust.
- a.** Assume the parade rest, port, or on-guard position.
  - b.** Move your left hand across the body toward the left.
  - c.** Move your right hand down and toward the left.
  - d.** Slide your left hand down the baton to the right hand. Your body and baton are now in position to defend with a counterblow.
- 13.** Defend yourself against an overhead stab.
- a.** Assume the parade rest, port, or on-guard position.
  - b.** Step backward with your left foot when the attacker stabs downward.
  - c.** Slide your left hand down the baton to meet the right, and raise the baton up over your left side and shoulder.
  - d.** Disarm the attacker by snapping the baton down against his wrist or forearm.
  - e.** Return your left hand and left foot to their original position in preparation to execute a baton smash.
- 14.** Defend yourself against an upward thrust.
- a.** Assume the parade rest, port, or on-guard position.
  - b.** Hold the baton horizontally, about 6 inches from your lower chest.
  - c.** Snap both arms straight down and strike the opponent's wrist to cause him to drop his weapon.
  - d.** Hold the baton with both your hands and immediately bring the baton close to your shoulders and hold it across your chest in preparation to execute the baton smash.
- 15.** Defend yourself against an unarmed attacker.
- a.** Slide your left hand toward your right and lift the baton to shoulder level, parallel to the ground.
-

---

**Performance Steps**

---

- b. Move your body slightly to the rear by withdrawing your left foot.
  - c. Use your baton to deliver a counterblow to the attackers shoulder or collarbone, if he attempts to strike you with a blow.
  - d. Deliver a counterblow to the attacker's right forearm, if he attempts to strike you with a blow.
  - e. Jab the attacker in the groin or stomach with your baton, if he attempts to grab you.
- 

**Evaluation Preparation:**

*Setup:* Provide the soldier being evaluated with a riot baton, a flak vest, and a helmet with a face shield.

*Brief Soldier:* Tell each soldier being evaluated that he must perform each step to correctly demonstrate the riot baton grip, the parade rest, port and on-guard positions, the three offensive techniques, and the six defensive techniques as described in performance measures 10 through 15.

Performance Measures	GO	NO GO
1. Gripped the riot baton.	___	___
2. Assumed the parade rest position.	___	___
3. Assumed the port position.	___	___
4. Assumed the on-guard position.	___	___
5. Ensured that a blow was not directed to one of the five fatal points.	___	___
6. Performed the short-thrust offensive technique from the on-guard position.	___	___
7. Performed the long-thrust offensive technique from the on-guard position.	___	___
8. Performed the butt-stroke offensive technique from the on-guard position.	___	___
9. Performed the baton smash offensive technique from the rest, port, or on-guard position.	___	___
10. Defended himself against a blow to the head.	___	___
11. Defended himself against a backhand blow.	___	___
12. Defended himself against a long thrust.	___	___

Performance Measures	GO	NO GO
13. Defended himself against an overhead stab.	___	___
14. Defended himself against an upward thrust.	___	___
15. Defended himself against an unarmed attacker.	___	___

**Evaluation Guidance:** Score the soldier GO if all performance measures are passed (P). Score the soldier NO GO if any performance measure is failed (F). If the soldier fails any performance measure, show him how to do it correctly.

**References**

**Required**

**Related**

FM 19-15

---

## 191-376-4122

### Position Yourself in Riot Control Formations

**Conditions:** You are given orders to be a member of a squad or platoon detailed in a crowd control situation. You are given a riot baton, an M16 rifle, a bayonet with a sheath, a flak vest, a protective mask, a helmet with a face shield, and shin guards.

**Standards:** Position yourself in a formation, as directed by the squad or platoon leader to control the crowd effectively.

---

**Performance Steps**

1. Assume the safe-port position as shown in Figure 191-376-4122-1.
-



---

**Performance Steps**

---



**Figure 191-376-4122-1. Safe-port position**

**Note.** Use this position when moving into a riot-control formation or when changing formations.

- a.** Grasp the small of the gun stock with your right hand. The forefinger should be toward the rear of the pistol grip.
  - b.** Use your left hand to hold the sling against the hand guard by grasping the weapon just below the sling and touching the upper swing swivel. Ensure that the magazine well faces away from your body.
-

---

**Performance Steps**

---

- c. Hold the upper part of your left arm parallel with the ground, and bend your elbow so the forearm is straight up.
  - d. Keep your right elbow close to the body.
  - e. Position the heel of the rifle butt slightly to the right of your right shirt pocket.
  - f. Slant the rifle enough to look straight ahead over the magazine well.
2. Assume the safeguard position as shown in Figure 191-376-4122-2.



**Figure 191-376-4122-2. Safeguard position**

- a. Use your right hand to grasp the small of the stock and hold it against the right side of your waist. The butt of the stock will extend to the rear of your buttocks.
-

---

**Performance Steps**

---

- b.** Use your left arm, slightly bent at the elbow, to grasp the weapon just below the sling swivel using your left hand. Turn the weapon so the magazine well is facing down.
  - c.** Raise the bayonet to throat level.
  - d.** Place your feet together as for the position of attention when at a halt.
- 3.** Assume the on-guard position as shown in Figure 191-376-4122-3.



**Figure 191-376-4122-3. On-guard position**

- a.** Grasp the pistol grip with your right hand and, using right forearm, hold the stock snugly against your right waist, with the rifle butt even with the right seam of your trousers.
-

---

**Performance Steps**

---

**b.** Use your left arm, slightly bent at the elbow, to grasp the weapon just below the sling swivel using your left hand. Turn the weapon so the magazine well is facing down.

**c.** Place your feet a comfortable distance apart when at a halt. Line up your left heel with your right toe and point your toes at the crowd. Slightly bend your knees, and lean forward while keeping your hips level. Point the bayonet at throat level.

**d.** Make a resounding stomp with your left foot when assuming the on-guard position.

**Note.** When using riot batons, execute the positions according to the supervisor's commands. Refer to Task 191-376-4121.

**4.** Form a squad line formation using the hand signal as shown in Figure 191-376-4122-4. Assume the safe-port position when the command "squad as skirmishers" is given or when the squad leader gives the hand-and-arm signal for a squad line formation.



Figure 191-376-4122-4. Hand signal for a squad line formation

---

---

**Performance Steps**

---

**Note.**

1. On the command "MOVE," the base member will double-time to the position indicated by the squad leader.
2. Remaining squad members will double-time forward and position themselves on line with the base member, one pace to the right of the preceding member.
3. Everyone will remain in the safe port position until ordered to another position.
4. Any size squad, platoon, or larger unit can be employed, and a crowd control formation can be adapted to fit the unit's organization.
5. Form the squad echelon-right formation using hand signals as shown in Figure 191-376-4122-5. Assume the safe port position when the command of "SQUAD ECHELON RIGHT" is given or when the squad leader gives the hand signal for an echelon-right formation.



**Figure 191-376-4122-5. Hand Signal for a squad right formation**

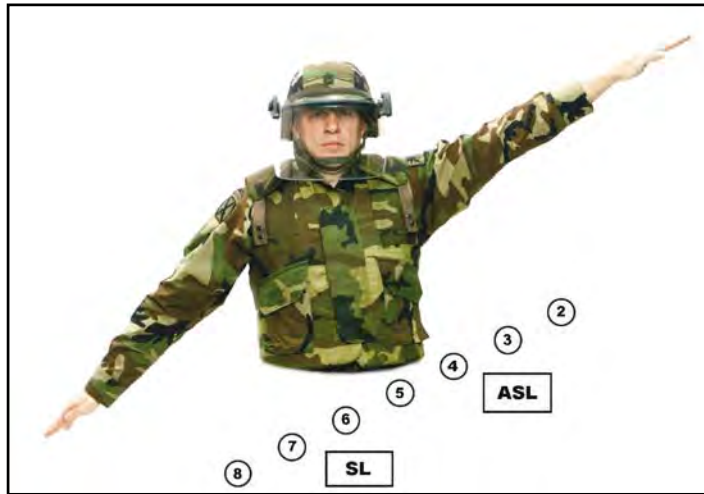
**Notes.**

1. On the command "MOVE," the base member will double-time to the position indicated by the squad leader.
  2. Remaining squad members will double-time forward and position themselves on line with the base member, one pace to the right and one pace to the rear of the preceding member.
  3. Everyone will remain at safe port until ordered to another position.
  6. Form a squad echelon-left formation (Figure 191-376-4122-6).
-

---

**Performance Steps**

---



**Figure 191-376-4122-6. Hand signal for a squad echelon-left formation**

7. Form the squad wedge formation using the hand signal shown in Figure 191-376-4122-7. Assume the safe-port position when the command "SQUAD WEDGE" is given or when the squad leader gives the hand signal for a wedge formation.



**Figure 191-376-4122-7. Hand signal for a squad wedge formation**

---

---

**Performance Steps**

---

**Notes.**

1. On the command "MOVE," the base member will double-time to the position indicated by the squad leader.
2. Remaining odd-numbered squad members will double-time forward and position themselves on line with the base member, one pace to the left and one pace to the rear of the preceding member.
3. Remaining even-numbered squad members will double-time forward and position themselves on line with the base member, one pace to the right and one pace to the rear of the preceding member.
4. Everyone will remain at the safe-port position until ordered to another position.

**8. Assemble from a riot control formation.**

**a.** On the command "SQUAD ASSEMBLE," assume the safe-port position.

**b.** On the command "MOVE," the base member will double-time to the position indicated by the squad leader.

**Note.** Remaining squad members will double-time forward and form a column behind the base member. Everyone will remain at the safe-port position until ordered to another position.

---

**Evaluation Preparation:**

*Setup:* Have each soldier being evaluated perform at every position within the formations.

*Brief Soldier:* Brief the soldier on the nine positions of a squad and review Task 191-376-4121.

Performance Measures	GO	NO GO
1. Assumed the safe-port position.	___	___
2. Assumed the safeguard position.	___	___
3. Assumed the on-guard position.	___	___
4. Formed a squad line formation using hand signals.	___	___
5. Formed the squad echelon-right formation using hand signals.	___	___
6. Formed a squad echelon left formation.	___	___
7. Formed a squad wedge formation.	___	___
8. Assembled from a riot control formation.	___	___

**Evaluation Guidance:** Score the soldier GO if all performance measures are passed. Score the soldier NO GO if any performance measure is failed. If the soldier fails any performance measure, show him how to do it correctly.

#### References

##### Required

TC 19-138

##### Related

FM 19-15

### SUBJECT AREA 20: CASUALTY REPORTING AND HANDLING

---

## 101-515-1997

### Inter Isolated Remains (After Receiving Authorization)

**Conditions:** In a tactical situation, given an order from your NCOIC, an entrenching tool, shrouding material, a separate container for loose personal effects, grid location of the remains, a transport vehicle.

**Standards:** After receiving authorization from the organizational commander, remains were interred according to JP 4-06.

---

#### Performance Steps

1. Select a burial site large enough to accommodate the remains to be buried.
    - a. Locate grave near the scene of death.

**Note.** Inter on high ground (avoid flood plains, etc.). Do not inter near water source.

    - b. Dig grave approximately 3 ½ feet deep.
  2. Prepare remains for interment.
    - a. Inventory all personal effects.
    - b. Record the following data for each individual interred: name, grade/rank, sex, service number, nationality, date of death, date buried, religious faith, who interred the remains.

**Note.** If any data is not known, write "unidentified."

    - c. Leave all personal effects and identification media on remains.
    - d. Shroud remains.
  3. Inter individual remains.
    - a. Place the remains face up in the grave.
    - b. Refill the grave.
    - c. Mark the grave.
  4. Record the location by coordinates using GPS, if available.
-



---

**Performance Steps**

---

**5. Submit an incident report on interment(s) to higher headquarters**

---

Performance Measures	GO	NO GO
1. Selected an appropriate interment site.	___	___
2. Prepared remains.	___	___
a. Inventoried personal effects and identification media on remains.		
b. Recorded all pertinent data on remains.		
c. Left personal effects and identification media on remains.		
d. Shrouded remains.		
3. Interred individual remains.	___	___
a. Placed the remains face up in the grave.		
b. Refilled the grave.		
c. Marked the grave.		
4. Recorded the location by coordinates using GPS (if available).	___	___
5. Submitted incident report on interment(s) to higher headquarters.	___	___

**Evaluation Guidance:** Score the soldier GO if all performance measures are passed. Score the soldier NO GO if any performance measure is failed. If the soldier scores NO GO, show him what was done wrong and how to do it correctly.

**References****Required**

JP 4-06

**Related**

FM 3-25.26

---

**101-515-1998****Evacuate Isolated Remains**

**Conditions:** In a tactical situation, given an order from your NCOIC, using a standard scale military map, grid coordinate scale, grid location of remains, communications equipment, transport vehicle (aircraft or ground), pencil or pen and blank paper.

101-515-1998

3-577

**Standards:** After a battle, remains have been recovered and tagged; requested evacuation of remains, and evacuated the remains by the best possible transportation according to JP 4-06.

---

**Performance Steps**

---

1. Establish assembly area.
  - a. Record grid coordinates of assembly area using a Global Positioning System (GPS), if available.
  - b. Secure assembly area.
  - c. Move remains feet first to assembly area to await transportation.
  - d. Contact battalion headquarters to request transportation assets for the evacuation of remains.

**Note.** The request for transportation for the evacuation of remains should contain the number of remains and location of recovery site. Any available air or ground transportation may be used to evacuate remains.

- e. Guard area to prevent loss of personal effects, equipment, and to keep unauthorized personnel away.
  - f. Mark landing zone if air evacuation is used.

2. Evacuate the remains, portions, and personal effects.

- a. Secure the remains in a vehicle or an aircraft.

**Note.** Remains are carried feet first. Remains will be loaded feet first on trucks and rotary-wing aircraft, and headfirst on fixed-wing aircraft.

- b. Evacuate remains to mortuary affairs facility.

**Note.** An escort, preferably the person who witnessed the circumstances surrounding the individual's death, accompanies the remains to prevent theft and unauthorized entry to the vehicle.

---

Performance Measures	GO	NO GO
1. Established assembly area.	___	___
a. Moved remains feet first to a central location or assembly area to await transportation.		
b. Recorded grid coordinates of assembly area using a GPS, if available.		
c. Contacted battalion headquarters to request transportation assets for the evacuation of remains.		
d. Guarded the area.		
e. Marked the landing zone if air evacuation was used.		

Performance Measures	GO	NO GO
2. Evacuated the remains, portions, and personal effects to a mortuary affairs facility.	—	—

**Evaluation Guidance:** Score the soldier GO if all performance measures are passed. Score the soldier NO GO if any performance measure is failed. If the soldier scores NO GO, show him what was done wrong and how to do it correctly.

#### References

##### Required

JP 4-06

##### Related

---

## 101-515-1999

### Recover Isolated Remains

**Conditions:** In a tactical situation, given a message prepared at higher headquarters listing the search area and number of remains, standard scale military map, compass, grid coordinate scale (protractor), writing paper, pen or pencil, grid location of the remains, transport vehicle, and communications equipment.

**Standards:** Remains were recovered according to JP 4-06.

---

#### Performance Steps

1. Prepare to move to recovery site.
    - a. Obtain all information concerning the incident from team leader.
    - b. Perform PMCS on vehicle(s) and equipment prior to loading.
    - c. Load vehicle according to the load plan.
    - d. Perform a map reconnaissance of the route.
    - e. Plot the grid azimuth to the recovery site from your assembly area on the military map to within one degree of accuracy using a global positioning system, if available.
    - f. Convert grid azimuth to a magnetic azimuth.
  2. Move to recovery site.
  3. Search for remains during daylight only.
    - a. Question local inhabitants about locations of gravesites and/or incidents concerning the loss of American service members.
    - b. Follow a systematic search pattern.
      - (1) Open formation. An open formation places each member side by side on a line at a double-arm interval.
-

---

### Performance Steps

---

**Note.** This formation allows team members to thoroughly cover a large area. Use the open formation in open areas or areas with sparse vegetation where visibility is good.

(2) Closed formation. A closed formation is much closer together. This formation places each member on line side by side at a close-arm interval.

**Note.** Use this formation in areas where the visibility is obstructed or limited due to dense vegetation or other terrain features.

c. Mark the location of all remains with stake and streamer.

**Note.** The other team members continue just past the marked location and stop. When the location has been marked, the personnel marking the location rejoin the main line of searchers and the sweep continues. Mark all remains in similar manner. Continue with this process until entire area is searched.

d. Search places that may have been used by troops as shelter, concealment, or cover.

(1) Search any unusual ground disturbances that may indicate sites of emergency burial, collapsed bunkers, or fighting positions.

(2) Search and investigate unusual odors, congregation of insects, scavenger birds, or animals.

**Note.** Safety and sanitation factors should be considered. Diseases can easily be transmitted through body fluids from the remains to individuals handling the remains. Units should provide recovery personnel with gloves and protective clothing before the mission, and adequate washing facilities after the mission.

4. Recover the remains.

a. Establish tentative identification by reviewing identification tags, wallets, clothing, and equipment markings.

**Note.** Do not separate identification media from remains.

b. Interview unit personnel regarding possible visual identification of remains.

c. Secure personal effects and identification media to the remains.

**Note.** Attempt to safeguard identification media found on the remains from destruction by body fluids, weather conditions, and other environmental conditions. This may be done by storing the items in a waterproof zip lock bag or by wrapping the items in a dry article of clothing.

d. Record the believed name of the deceased, unit, and grid coordinates (or unidentified if unknown) on a blank piece of paper.

e. Attach military equipment, to include serially numbered weapons, and compasses to the remains and forward with the remains.

---

---

**Performance Steps**

---

**Note.** Ensure rifles and pistols are unloaded and do not pose a danger to the recovery team.

f. Search the area surrounding the remains for loose personal effects, equipment, and fragmented remains.

**Note.** In cases where remains are fragmented, attempt to recover as much of the remains as possible. Make every attempt to recover hands, individual fingers, teeth and dental appliance (dentures, bridges, etc.). No piece or portion is considered too small. DNA testing may make it possible to make positive identification based on body tissue, dentition, hair samples, and other items.

g. Tag each individual portion for evacuation.

**Note.** Do not attempt to associate any unassociated portions (such as a hand, arm, leg, fingers, or loose teeth) found to a particular remains.

h. Place personal effects found near the remains in a separate container or personal effects bag.

**Note.** Personal effects found in the vicinity of the remains are considered to be unassociated personal effects.

i. Make a sketch of the recovery site, identifying any major points of reference to determine the exact recovery site location for the remains.

(1) Use grid coordinates to pinpoint location.

(2) Show distance from any prominent landmarks in the vicinity to the grave(s).

j. Shroud the remains.

k. Place the remains on a litter.

l. Inform team leader that the remains are prepared for evacuation.

---

Performance Measures	GO	NO GO
1. Prepared to move to recovery site.	___	___
a. Performed PMCS on vehicle(s) and equipment prior to loading.		
b. Loaded vehicle according to the load plan.		
c. Performed a map reconnaissance of the route.		
d. Plotted grid azimuth on the military map to the recovery site from assembly area.		
e. Converted grid azimuth to a magnetic azimuth.		
2. Moved to recovery site.	___	___

Performance Measures	GO	NO GO
3. Searched for remains according to JP 4-06.	___	___
a. Questioned local inhabitants.		
b. Followed a systematic search pattern.		
4. Recovered remains according to JP 4-06.	___	___
a. Recorded tentative identification data on a blank piece of paper.		
b. Secured personal effects and ID media to remains.		
c. Recorded grid coordinates of recovery.		
d. Shrouded remains.		

**Evaluation Guidance:** Score the soldier GO if all performance measures are passed. Score the soldier NO GO if any performance measure is failed. If the soldier scores NO GO, show him what was done wrong and how to do it correctly.

#### References

##### Required

JP 4-06

##### Related

FM 3-25.26

**SUBJECT AREA 21: DEFENSE MEASURES**

## 052-191-1361

### Camouflage Yourself and Your Individual Equipment

**Conditions:** Given load-carrying equipment (LCE), an individual weapon, a Kevlar helmet with camouflage cover, grass, bushes, trees, shadows, pieces of the lightweight camouflage screen system (LCSS), skin paint, and charcoal and/or mud for camouflage. You are wearing a battle dress uniform (BDU).

**SPECIAL CONDITIONS:** When this task is performed in a nuclear, biological and chemical (NBC) environment, there will be no change in standards due to mission-oriented protective posture (MOPP) 4.

**Standards:** Camouflage yourself and your individual equipment to prevent detection by visual, near-infrared, infrared, ultraviolet, radar, acoustic, and radio sensors.

---

**Performance Steps**

---

**1.** Identify critical camouflage considerations, incorporating an analysis of the following considerations:

**a.** Movement.

**Note.** Movement draws attention, and darkness does not prevent observation. The naked eye and infrared/radar sensors can detect movement.

**(1)** Minimize movement.

**(2)** Move slowly and smoothly when movement is necessary.

**b.** Shape.

**(1)** Use artificial materials to break up shapes, outlines, and equipment.

**(2)** Stay in shadows when moving.

**(3)** Disguise or distort the shape of your helmet and your body with artificial materials when conducting operations close to the enemy.

**c.** Light reflection. Cover or remove the following items eliminating light reflection:

**(1)** Mess kits.

**(2)** Mirrors.

**(3)** Eye glasses.

**(4)** Watch crystals.

**(5)** Plastic map cases.

**(6)** Starched uniforms.

**(7)** Clear plastic garbage bags.

**(8)** Dust goggles worn on top of helmets.

**(9)** Cigarettes and pipes.

**(10)** Red-filtered flashlights.

**Note.** Replace all red filters on flashlights with blue-green filters.

**d.** Color. Blend individual camouflage with the surroundings, or at a minimum, ensure that objects do not contrast with the background (figure 052-191-1361-1).

**Note.** When moving from one area to another, change camouflage as required. What works well in one location may draw fire in another.

**2.** Camouflage your skin.

---

---

**Performance Steps**

---



**Figure 052-191-1361-1. Colors used in camouflage**

---

**Note.** Exposed skin reflects light.

**a.** Cover your skin oils, even if you have very dark skin, using paint sticks.

**Note.** Paint sticks cover these oils and provide blending with the background.

**Note.** Do not use oils or insect repellent to soften paint sticks. This defeats the purpose of paint sticks by making the skin shiny. Work in pairs when applying paint, because self-application may leave gaps, such as behind the ears.

**b.** Use information in table 052-191-1361-1 when applying paint on the face.

---



**Performance Steps**

Table 052-191-1361-1. Color Chart

	<b><i>Skin Color</i></b>	<b><i>Shine Areas</i></b>	<b><i>Shadow Areas</i></b>
Camouflage material	Light or dark	Forehead, cheekbones, ears, nose, and chin	Around eyes, under nose, and under chin
Loam and light green stick	All troops use in areas with green vegetation	Use loam	Use light green
Sand and light green stick	All troops use in areas lacking green vegetation	Use light green	Use sand
Loam and white	All troops use only in snow-covered terrain	Use loam	Use white
Burnt cork, bark charcoal, or lamp black	All troops, if camouflage sticks not available	Use	Do not use
Light-color mud	All troops, if camouflage sticks not available	Do not use	Use

**c.** Paint high, shiny areas (forehead, cheekbones, nose, ears, chin) with a dark color.

**d.** Paint low, shadow areas with a light color.

**e.** Paint exposed skin on the back of the neck, arms, and hands with an irregular pattern.

**CAUTION**

Mud contains bacteria, some of which is harmful and may cause disease or infection. Mud should be considered as a last resort as field expedient paint.

**CAUTION**

Expedient paint containing motor oil should be used with extreme caution.

**3.** Camouflage your BDU and helmet.

**a.** Roll your sleeves down and button all buttons.

**b.** Attach leaves, grass, small branches, or pieces of LCSS to your uniform and helmet (figure 052-191-1361-2).

---

Performance Steps

---



**Figure 052-191-1361-2. Camouflaged helmet**

---

**Note.** These items will distort shapes and blend colors with the natural background.

**Note.** BDUs provide visual and near-infrared camouflage.

---

**c.** Do not starch BDUs.

---

**Note.** Starch counters the infrared properties of the dyes.

---

**d.** Replace excessively faded and worn BDUs because camouflage effectiveness is lost.

---

---

**Performance Steps**

---

**4.** Camouflage your personal equipment.

**a.** Cover or remove shiny items.

**b.** Secure items that rattle or make noise when moved or worn.

---

**Evaluation Preparation:**

*Setup:* Ensure that all materials required in the conditions are available to the soldier. The buddy system should be used when applying paint to the face.

*Brief Soldier:* Tell the soldier, in preparation for unit defense, he is to identify critical camouflage considerations, camouflage himself or a buddy's exposed skin with paint sticks, and camouflage his individual equipment.

<b>Performance Measures</b>	<b>GO</b>	<b>NO GO</b>
<b>1.</b> Identified critical camouflage considerations.	___	___
<b>a.</b> Minimized movement, and moved slowly and smoothly.		
<b>b.</b> Broke up, disguised, or distorted shapes and outlines.		
<b>c.</b> Covered or removed light-reflecting items.		
<b>d.</b> Blended camouflage with the natural surroundings.		
<b>2.</b> Camouflaged exposed skin.	___	___
<b>a.</b> Selected the correct combination of paint sticks for the present location.		
<b>b.</b> Used paint sticks to camouflage exposed skin on face with irregular patterns.		
<b>c.</b> Used paint sticks to camouflage exposed areas of neck, arms, and hands with irregular patterns.		
<b>3.</b> Camouflaged uniform and helmet.	___	___
<b>a.</b> Ensured that uniform was not faded or starched.		
<b>b.</b> Rolled down and buttoned both sleeves.		
<b>c.</b> Broke up shape and pattern by attaching leaves, grass, small branches, and/or pieces of LCSS to uniform and helmet.		
<b>4.</b> Camouflaged personal equipment.	___	___

Performance Measures	GO	NO GO
a. Covered or removed all items that reflected light (for example, mess kits, mirrors, eye glasses, watch crystals, plastic map cases, starched uniforms, plastic map cases, clear plastic garbage bags, goggles worn on top of helmet, and red-filtered flashlights).		
b. Secured items that rattled or made noise when moved or worn.		

**Evaluation Guidance:** Score the soldier GO if all performance measures are passed. Score the soldier NO GO if any performance measure is failed. If the soldier fails any performance measure, show him how to do it correctly.

#### References

##### Required

##### Related

FM 20-3  
FM 21-75

---

## 052-191-1362

### Camouflage Equipment

**Conditions:** Given an item of equipment to camouflage, such as a wheeled vehicle (truck or jeep) or a tracked vehicle (armored personnel carrier [APC] or infantry fighting vehicle) and the lightweight camouflage screen system (LCSS) or natural camouflage material (such as burlap, sandbags, and cloth strips). You are wearing a battle dress uniform (BDU).

*Special Conditions:* When this task is to be performed in a nuclear, biological, and chemical (NBC) environment, there will be no change in standards due to mission-oriented protective posture (MOPP) 4.

**Standards:** Camouflage equipment so all shiny parts are concealed, all remaining parts of the equipment are covered in irregular patterns, and outlines blend with predominant terrain background in the area. Camouflage equipment to prevent detection by visual, near-infrared, infrared, ultraviolet, radar, acoustic, and radio sensors.

---

#### Performance Steps

1. Hide the equipment by positioning it—
    - a. Under natural cover (whenever possible).
    - b. Within natural shadows (whenever possible).
    - c. In natural or constructed depressions in the ground.
    - d. So it is concealed by existing vegetation (whenever possible).
-

**Performance Steps**

2. Use the LCSS or natural camouflage materials to break up the shape and outline of the equipment so it blends in with the surrounding area. (figure 052-191-1362-1)

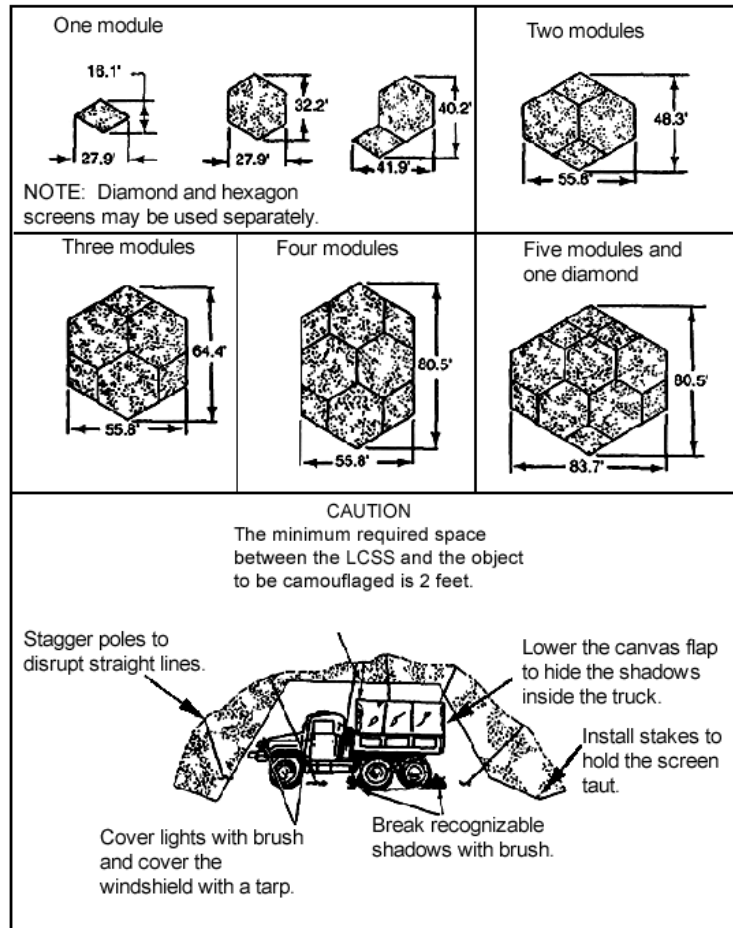


Figure 052-191-1362-1. Camouflage nets

3. Cover all shiny areas of the equipment, such as headlights, reflectors, mirrors, and windshields.

---

**Performance Steps**

---

4. Cover or brush out obvious tracks that lead to the equipment.
- 

**Evaluation Preparation:**

*Setup:* Provide the soldier with equipment to be camouflaged as listed in the conditions.

*Brief Soldier:* Tell the soldier he is to camouflage the vehicle or piece of equipment in preparation for unit defense.

Performance Measures	GO	NO GO
1. Hid the equipment by positioning it—	___	___
a. Under natural cover (whenever possible)		
b. Within natural shadows (whenever possible)		
c. In natural or constructed depressions in the ground.		
d. So it was concealed by existing vegetation (whenever possible).		
2. Used the LCCS or natural camouflage materials to break up the shape and outline of the equipment so it blended with the surrounding area.	___	___
3. Covered all shiny areas of the equipment, such as headlights, reflectors, mirrors, and windshields.	___	___
4. Covered or brushed out obvious tracks that led to the equipment.	___	___

**Evaluation Guidance:** Score the soldier GO if all performance measures are passed. Score the soldier NO GO if any performance measure is failed. If the soldier fails any performance measure, show him what was done wrong and how to do it correctly.

**References****Required****Related**

FM 20-3

FM 21-75

---

## 191-376-4114

### Control Entry to and Exit from a Restricted Area

**Conditions:** You are assigned to control entry to, and exit from, a restricted area. You are given special orders, identification cards or badges, local standing operating procedures (SOPs), access rosters, communications equipment, locally produced forms, and the current duress code.

**Standards:** Prevent unauthorized personnel, packages, and/or vehicles from entering or leaving the restricted area.

---

#### Performance Steps

---

1. Identify personnel before allowing them to enter or exit the restricted area.
    - a. Ensure that only one individual is processed in or out at any given time.
    - b. Verify the person's identity by comparing the person's face with the photograph on the identification card.
    - c. Ensure the name of the person attempting to enter is on the access roster. The site commander or custodian must authenticate the roster.
    - d. Obtain authority to enter, if applicable, for personnel whose names are not on the access roster. Call the sergeant of the guards, the security officer, or the vouching officer.
    - e. Ensure that personnel entering the facility know the most direct route to their destination.
  2. Use the following card and badge systems:
    - a. Single card or badge system. Permission to enter is shown on the card or badge by letters, numerals, or colors.
    - b. Card or badge exchange system.
      - (1) The individual entering the area presents the badge or card to the guard and the guard exchanges it with the card or badge kept at the entrance.
      - (2) The individual again exchanges the card or badge when leaving the area.

**Note.** Always keep the second card or badge in the area.

    - c. Multiple card or badge system.
      - (1) Exchange the card or badge at the entrance to each security area within the installation.
      - (2) Keep cards and badges at each area only for those personnel who have the appropriate card or badge.
-

---

**Performance Steps**

---

(3) Brief the badge holder that the badge must be displayed at all times when in the controlled or restricted area.

**Note.** For comparison purposes, card and badge data are identical.

3. Obtain an escort for visitors with authority to enter the restricted area according to special orders.
4. Use challenges, passwords, and code words in tactical areas.
5. Use a duress code.
6. Check the authorization for vehicle entry and exit.
  - a. Log all vehicles entering or leaving the area. Include in the log the description of the vehicle, the identity of the driver, the purpose of the visit, and the destination.
  - b. Arrange an escort for all vehicles entering the area according to special orders.
7. Prohibit entry (into the restricted area) of harmful materials, such as matches, cameras, and any other items prohibited by the special orders.
  - a. Be alert for the wrongful appropriation, pilferage, or compromise of materials or recorded information.
  - b. Make periodic spot checks of personnel.
  - c. Search all packages.
  - d. Search vehicles before allowing them to enter or exit.
8. Take the appropriate actions in the event of a security violation.
  - a. Detain the suspect until help arrives.
  - b. Report a discovery of security violations.
  - c. Apprehend the suspect.
  - d. Prepare a detailed, written report.

---

**Evaluation Preparation:**

*Setup:* Create scenarios using the various control techniques and provide the materials and equipment necessary for each. Have other soldiers role play the part of authorized and unauthorized personnel.

*Brief Soldier:* Tell the soldier being evaluated the challenge word, password, code word, or duress code to be used.

Performance Measures	GO	NO GO
1. Identified personnel before allowing them to enter or exit the restricted area.	___	___
2. Used the card and badge systems.	___	___



Performance Measures	GO	NO GO
3. Obtained an escort for visitors with authority to enter the restricted area according to special orders.	___	___
4. Used challenges, passwords, and code words in tactical areas.	___	___
5. Used a duress code.	___	___
6. Checked the authorization for vehicle entry and exit.	___	___
7. Prohibited entry (into the restricted area) of harmful materials, such as matches, cameras, and any other items prohibited by the special orders.	___	___
8. Took the appropriate actions in the event of a security violation.	___	___

**Evaluation Guidance:** Score the soldier GO if all performance measures are passed. Score the soldier NO GO if any performance measure is failed. If the soldier fails any performance measure, show him what was done wrong and how to do it correctly.

#### References

**Required**  
TC 19-138

**Related**  
AR 50-5  
FM 22-6

---

## 301-371-1000

### Report Intelligence Information

**Conditions:** You have observed enemy activity, significant terrain, and weather features and must immediately report the activity to your chain of command via radio, wire, cable, or messenger.

**Standards:** Submitted observations in a spot report, using the SALUTE format, to your chain of command, within five minutes of observing enemy activity. You correctly identified six out of six SALUTE items.

---

#### Performance Steps

1. Identify enemy activity. Determine whether observed activity is friendly or enemy. If unable to make determination, report activity as unknown.
  2. Record information in a spot report, using the SALUTE format.
-

---

**Performance Steps**

---

**a.** Spot report is a report containing information for which speed of transmission is essential. A spot report does not have a prescribed format, but use of the SALUTE format will ensure reporting of essential information.

**b.** Define SALUTE acronym.

**(1)** S—Size. Report the number of personnel, vehicles, aircraft, or size of an object.

**(2)** A—Activity. Report detailed account of actions, for example, direction of movement, troops digging in, artillery fire, type of attack, NBC activity, etc.

**(3)** L—Location. Report where you saw the activity. Include grid coordinates or reference from a known point including the distance and direction from the known point.

**(4)** U—Unit. Report the enemy's unit. If the unit is unknown, report any distinctive features, such as uniforms, patches or colored tabs, headgear, vehicle identification markings, etc.

**(5)** T—Time. Report the time the activity was observed, not the time you report it. Always report local or Zulu time.

**(6)** E—Equipment. Report all equipment associated with the activity, such as weapons, vehicles, tools. If unable to identify the equipment, provide as much detail as you can so an identification can be made by higher headquarters.

**(c)** Remarks. Include any information not included in the SALUTE format.

**3.** Provide spot report to chain of command.

---

**Evaluation Preparation:**

*Setup:* Position two to four personnel (dressed in aggressor uniforms if available) where they are observable with the naked eye (or binoculars if available). Direct the aggressors to perform some type of activity such as setting up camp, cleaning weapons, working on a vehicle, or studying maps. Provide the soldier with a 1:50,000 scale topographic map of the test area. If you require the soldier to write the report, provide paper and pen or pencil. If you require the soldier to radio the report to someone else, provide two radios and an SOI.

**Brief Soldier:** Have the soldier write or radio the report of activity to the chain of command.

Performance Measures	GO	NO GO
1. Recorded observations of enemy activity in a spot report which included:	—	—
a. Size.		
b. Activity.		
c. Location.		
d. Unit.		
e. Time.		
f. Equipment.		
2. Reported all information to the chain of command within five minutes of observation.	—	—

**Evaluation Guidance:** Score the soldier GO if all performance measures are passed within five minutes. Score the soldier NO GO if any performance measure is failed. If a soldier scores NO GO, show him what was done wrong and how to do it correctly.

#### References

##### Required

FM 21-75

##### Related

---

### 301-371-1050

#### Implement Operations Security (OPSEC) Measures

**Conditions:** You have received a unit OPSEC plan, which includes essential elements of friendly information, indicators, vulnerabilities, OPSEC measures, and AR 530-1.

**Standards:** Implemented OPSEC measures based on unit indicators and vulnerabilities; protected unit essential elements of friendly information against threat collection efforts and prevented compromise.

---

#### Performance Steps

1. Define OPSEC.
    - a. OPSEC is a process of analyzing friendly actions pursuant to military operations and other activities to—
      - (1) Identify those friendly actions that can be observed by the threat.
      - (2) Determine indicators that the threat might obtain that could be interpreted or pieced together to derive critical information in time to be useful.
-

---

**Performance Steps**

---

**(3)** Select and execute measures that eliminate or reduce to an acceptable level the vulnerabilities of friendly actions to the threat exploitation.

**b.** OPSEC maintains essential secrecy, which is the condition achieved by the denial of critical information to the threat. Threat possession of critical information can prevent friendly mission accomplishment. Thus, essential secrecy is a necessary prerequisite for effective operations. Essential secrecy depends on the combination of two conditions:

**(1)** Provide traditional security programs that deny the threat classified information.

**(2)** Provide OPSEC to deny the threat critical information, which is always sensitive and often unclassified.

**2.** Define indicators.

**a.** Indicators are data derived from open sources or from detectable actions that the threat can piece together or interpret to reach conclusions or official estimates concerning friendly intentions, capabilities, or activities. They are also activities that result from military operations. Indicators contribute to the determination of friendly courses of action. Their identification and interpretation are critical tasks of the threat operations. Indicators can be used in many ways. For example, if the commander wants the threat to think one way but, in reality plans on doing something entirely different, he may give him a false indicator (such as massing a smaller force to disguise a larger objective).

**b.** There are three types of indicators:

**(1)** Profile indicators show how activities are normally conducted. Profiles are developed by looking at all aspects of friendly operations from the viewpoint of the threat. The friendly profile must include all of those things that, if detected by the threat, could provide information concerning our capabilities, vulnerabilities, and intentions.

**(a)** Patterns are stereotyped actions that occur so habitually that they can cue an observer to either the type of military unit or activity, its identity, capabilities, or intent. The Army tends to do things in the same way (SOP). This causes patterns that the threat looks for so he can predict intentions.

**(b)** Signatures result from the presence of a unit or activity on the battlefield. Signatures are detected because different units have different types of equipment, are of different sizes, emit different electronic signals, and have different noises associated with them.

---

---

**Performance Steps**

---

(2) Deviation indicators, which highlight contrasts to normal activity, help the threat gain appreciation about intentions, preparations, time, and place.

(3) Tip-off indicators draw attention to information that otherwise might pass unnoticed. These are most significant when they warn the threat of impending activity. This warning allows the threat to pay closer attention and to task additional collection assets.

**3. Identify threat capabilities.**

**a.** The threat consists of multiple and overlapping collection efforts targeted against all sources of Army information. The threat devotes significant resources to monitor U.S. military operations and activities on a daily basis. The threat can produce reliable information on the U.S. military and its capabilities, intentions, and vulnerabilities. The threat is also shifting the emphasis in targeting. Foreign targeting of American technology is increasing for economic as well as military reasons. Technology transfer will continue to remain a major concern in the future.

**b.** The major threat collection capabilities fall in four areas:

(1) Human intelligence (HUMINT) includes all information derived through human sources not accessible to other collection assets. HUMINT employs overt, covert, and clandestine operations to achieve worldwide collection objectives.

(2) Imagery intelligence (IMINT). The threat can obtain IMINT from land, sea, air, and space platforms (radar, photographic, infrared, and electro-optic imagery). At the tactical level, airborne collection possesses the greatest IMINT threat.

(3) Signals intelligence (SIGINT) results from the collection, evaluation, analysis, integration, and interpretation of information derived from intercepted electromagnetic emissions.

(4) Measurement and signature intelligence (MASINT) is scientific and technical intelligence obtained by quantitative and qualitative analysis of data derived from technical sensors for the purpose of identifying any distinctive features associated with the source, emitter, or sender and to facilitate subsequent identification or measurement.

**c.** Two additional areas of concern:

(1) Technology transfer, which has led to significant enhancement of military-industrial capabilities at the expense of the United States.

(2) Non-traditional threats. Past and present allies are potential intelligence threats. They can engage in intelligence collection activities to gain economic or political advantage, which is not in the best interest of the United States.

---

---

**Performance Steps**

---

**4. Define OPSEC measures.** OPSEC measures are methods and means to gain and maintain essential secrecy about critical information.

**a.** Action control eliminates indicators. Select what action to undertake, decide whether or not to execute actions, or impose restraints on actions. (Specify who, when, where, and how.)

**b.** Countermeasures attack the threat collection system by using—

- (1)** Diversions.
- (2)** Camouflage.
- (3)** Concealment.
- (4)** Jamming.
- (5)** Deception.

**5. Implement the OPSEC Process.** OPSEC has five steps that apply to any plan, operation, program, project, or activity. They provide a framework for the systematic process necessary to identify, analyze, and protect information for essential secrecy. The process is continuous. It considers the changing nature of the threat and friendly vulnerabilities throughout the operation. It uses the following steps, but does not have to follow them in a particular sequence.

**a.** Identify critical information. Critical information consists of specific facts about friendly intentions, capabilities, and activities vitally needed by the threat to plan effectively and to guarantee failure or unacceptable consequences for friendly mission accomplishment.

**(1)** Determine what needs protection.

**(2)** Identify key questions that threat officials are likely to ask about friendly intentions, capabilities, and activities, so they can obtain answers critical to their operational effectiveness. To determine sensitive aspects of our operations, ask "If known by the threat, what information and what actions could compromise friendly operations or identify us?"

**(3)** Identify friendly force profile. The G3 and the G2 are responsible for developing friendly force profiles.

**(4)** Avoid setting patterns.

**b.** Conduct an analysis of threats.

**(1)** Identify OPSEC vulnerabilities. It is absolutely necessary that you know the threat. This information will assist in determining vulnerabilities to the threat and it will become even more important when the time comes to implement countermeasures or deception measures.

---

---

**Performance Steps**

---

(2) Examine each part of the operation to find OPSEC indicators. Compare those indicators with the threat collection capabilities. A vulnerability exists when the threat can collect an indicator, correctly analyze the information, make a decision, and take timely action to degrade friendly operations.

c. Conduct an analysis of vulnerabilities.

(1) Identify possible OPSEC measures for each vulnerability.

(2) Select at least one OPSEC measure for each vulnerability.

(3) Assess the sufficiency of routine security measures (personnel, physical, cryptographic, document, special access, and automated information systems). This will provide OPSEC measures for some vulnerabilities.

d. Perform risk assessment. The purpose of this step is to select OPSEC measures for implementation. This step is designed to determine if a risk to an operation's success exists should the threat detect friendly indicators, patterns, or signatures. Only the commander responsible for the mission can make this decision. He must balance the risk of operational failure against the cost of OPSEC measures.

(1) Consider the impact of an OPSEC measure on operational efficiency.

(2) Consider the probable risk to mission success (effectiveness) if the unit does not implement an OPSEC measure.

(3) Consider the probable risk to mission success if an OPSEC measure does not work.

(4) Decide which, if any, OPSEC measures to implement and when to do so.

(5) Check the interaction of OPSEC measures. Ensure that a measure to protect a specific piece of critical information does not unwittingly provide an indicator of another.

(6) Coordinate OPSEC measures with the other elements of C2W.

e. Apply appropriate countermeasures to deny threat information of specific friendly intentions, capabilities, and activities.

(1) Implement measures that require immediate action. This applies to current operations as well as planning and preparation for future ones.

(2) Document or task OPSEC measures by using an OPSEC annex to the OPLAN/OPORD.

---

---

**Performance Steps**

---

(3) Brief OPSEC requirements to planners, participants, and support personnel.

**Note.** OPSEC measures are command-directed actions executed by individuals, who must be aware of their responsibilities.

(4) Monitor OPSEC measures during execution. Monitoring is a continuous process of evaluating intelligence and counterintelligence. It is necessary to monitor countermeasures for effectiveness because unevaluated countermeasures can lead to a false and dangerous sense of security.

(5) Make adjustments to improve the effectiveness of existing measures. These adjustments are necessary to obtain the best protection for our military operations.

6. Define OPSEC review, assessment, and survey.

a. OPSEC review is an evaluation of a document to ensure protection of sensitive or critical information.

b. OPSEC assessment is an analysis of an operation, activity, exercise, or support function to determine the overall OPSEC posture and to evaluate the degree of compliance of subordinate organizations with the published OPSEC plan or OPSEC program.

c. OPSEC survey is a method to determine if there is adequate protection of critical information during planning, preparations, execution, and post-execution phases of any operation or activity. It analyzes all associated functions to identify sources of information, what they disclose, and what can be derived from the information.

---

**Evaluation Preparation:**

*Setup:* Provide the soldier with the materials listed in the conditions.

*Brief Soldier:* Tell the soldier to maintain OPSEC procedures to protect critical aspects of operations from exploitation by threat intelligence.

Performance Measures	GO	NO GO
1. Defined OPSEC.	___	___
2. Defined indicators.	___	___
3. Identified threat capabilities.	___	___
4. Identified OPSEC measures.	___	___
5. Implemented OPSEC measures.	___	___
a. Identified critical information.		



<b>Performance Measures</b>	<b>GO</b>	<b>NO GO</b>
(1) Determined what protection was needed.		
(2) Identified key questions the threat are likely to ask about friendly intentions, capabilities, and activities.		
(3) Identified friendly force profile.		
(4) Avoided setting patterns.		
<b>b. Conducted analysis of threats.</b>		
(1) Identified OPSEC vulnerabilities.		
(2) Found OPSEC indicators.		
<b>c. Conducted an analysis of vulnerabilities.</b>		
(1) Identified OPSEC measures for each vulnerability.		
(2) Selected OPSEC measure for each vulnerability.		
(3) Assessed the sufficiency of routine security measures.		
<b>d. Performed risk assessment.</b>		
(1) Considered the impact of an OPSEC measure on operational efficiency.		
(2) Considered the probable risk to mission success if the unit does not implement an OPSEC measure.		
(3) Considered the probable risk to mission success if an OPSEC measure does not work.		
(4) Decided which OPSEC measures to implement.		
(5) Checked the interaction of OPSEC measures.		
(6) Coordinated OPSEC measures with the other elements of C2W.		
<b>e. Applied appropriate countermeasures to deny threat friendly information.</b>		
(1) Implemented measures that require immediate action.		
(2) Tasked OPSEC measures using OPSEC annex.		
(3) Briefed OPSEC requirements to planners, participants, and support personnel.		

Performance Measures	GO	NO GO
(4) Monitored OPSEC measures during execution.		
(5) Made adjustments to improve the effectiveness of existing measures.		
6. Defined OPSEC review, assessment, and survey.	___	___
a. Defined OPSEC review.		
b. Defined OPSEC assessment.		
c. Defined OPSEC survey.		

**Evaluation Guidance:** Score the soldier GO if all performance measures are passed. Score the soldier NO GO if any performance measure is failed. If the soldier fails any performance measures, show him what was done wrong and how to do it correctly.

#### References

##### Required

AR 530-1

FM 100-5

FM 34-1

FM 34-60

##### Related

**Appendix A**

**Proponent School or Agency Codes**

The first three digits of the task number identify the proponent school or agency responsible for the task. Record any comments or questions regarding the task summaries contained in this manual on a DA Form 2028 (*Recommended Changes to Publications and Blank Forms*) and send it to the proponent school with an information copy to: Commander, U.S. Army Training Support Center, ATTN: ATIC-ITSC-CM, Fort Eustis, VA 23604-5166.

<b>Table A-1. Proponent School or Agency Codes</b>	
<b>School Code</b>	<b>Command</b>
MANSCEN CM <b>031</b> EN <b>052</b> MP <b>191</b>	MANSCEN, Directorate of Training Development US Army Engineer Center and Fort Leonard Wood 320 Engineer Loop, Suite 220 Fort Leonard Wood, MO 65473-8929
IN <b>071</b>	Commandant, U.S. Army Infantry School ATTN: ATSH-OTDD Fort Benning, GA 31905-5700
AHS <b>081</b>	USAAHS, Dean, AHS ATTN: MCCS-HTI Fort Sam Houston, TX 78234-6122
SIG <b>113</b>	Commander, USA Signal Center & School ATTN: ATZH-DTM-U Fort Gordon, GA 30905-5074
JAG <b>181</b>	Commandant, Judge Advocate General School ATTN: JAGS-TDD 600 Massie Road Charlottesville, VA 22903-1781
APAC <b>224</b>	Director, Army Public Affairs Center 6 ACR Road, Bldg 8607 ATTN: SAPA-PA Fort Meade, MD 20755-5650

<b>Table A-1. Proponent School or Agency Codes</b>	
<b>School Code</b>	<b>Command</b>
MI <b>301</b>	Commander, USA Intelligence Center & Fort Huachuca ATTN: ATZS-FDR-TA Fort Huachuca, AZ 85613-6000
JFK <b>331</b>	Commander USA John F Kennedy Special Warfare Center and School ATTN: AOJK-DT-DMO Fort Bragg, NC 28310-5000
CASCOM <b>093</b> <b>101</b> <b>551</b>	U.S. Army Combined Arms Support Command (CASCOM) Training Directorate USACASCOM, ATTN: ATCL-A 401 First St., Suite 227 Fort Lee, VA 23801-1511
SSI <b>805C</b>	Commander, USA Soldier Support Institute ATTN: ATSG-TD-HRD Fort Jackson, SC 29207-7065

**Appendix B**  
**GUIDE TO FORMS**

This appendix contains a list of forms pertinent to SMCT and CTT evaluations and administration. In the electronic, online version of this manual, hot links will, where indicated, provide downloadable and reproducible copies of the forms. The user can also visit the CTT site in the Reimer Digital Library where access to the **CTT Manual** and **CTT Notice** (Bulletin) provide additional helpful information and links. Some of these forms may be available in your unit.

**DA Form 5164-R** (*Hands On Evaluation*), used by CTT scorer to record GO/NO GO for each performance measure in a given task. Refer to the CTT Manual for the current FY (in the Reimer Digital Library) for links to DA Forms 5164-R that are overprinted with the performance measures for each task on the current CTT.

**CTT Performance Sheet** used by the CTT scorer to compile all GO/NO GO scores to produce an overall GO or NO GO for the soldier's common task test. As with the Hands On Evaluation form above, the CTT Performance Sheet is different for each FY; it is overprinted with the tasks from the current CTT and linked from the CTT Manual (in the Reimer Digital Library) for the current FY.

**DA Form 5165-R** (*Field Expedient Squad Book*), used to record task proficiency for groups of soldiers in a squad. This squad book should be especially beneficial for recording training results gathered during MTP, field exercises, or individual training sessions. Once training is completed, trainers may transfer information from DA Form 5165-R to the leader book (FM 7-10).

**CTT Roll Up for SL 1-2 and SL 3-4**, used by trainers and administrators to record performances for larger, unit-size groups of soldiers. This form is a good means of seeing and reporting an overall ratio of soldiers passing the CTT to the total of those tested.

**DA Form 2028** (*Recommended Changes to Publications and Blank Forms*), used by soldiers and trainers to record any comments or questions regarding the task summaries contained in this manual. Use the task proponent address for the appropriate proponent code given in appendix A (first three digits of the task number).



## Appendix C

### Land Navigation Supporting Tasks

1. Select a Movement Route Using a Map
2. Identify Topographic Symbols on a Military Map
3. Identify Terrain Features on a Map
4. Determine the Grid Coordinates of a Point on a Military Map
5. Determine a Magnetic Azimuth Using a Lensatic Compass
6. Determine the Elevation of a Point on the Ground Using a Map
7. Determine a Location on the Ground by Terrain Association
8. Measure Distance on a Map
9. Convert Azimuths
10. Orient a Map Using a Lensatic Compass
11. Orient a Map to the Ground by Map-Terrain Association
12. Locate an Unknown Point on a Map and on the Ground by Intersection
13. Locate an Unknown Point on a Map and on the Ground by Resection
14. Determine Direction without a Compass
15. Determine Azimuths Using a Protractor
16. Compute Back Azimuths

---

#### Land Navigation Task 1

##### Select a Movement Route Using a Map

**Conditions:** Given an operation or fragmentary order, a 1:50,000 scale military map, and a compass.

**Standards:** Selected a route with the following characteristics:

1. Took advantage of maximum cover and concealment.
2. Ensured observation and field of fire for the overwatch or fire support elements.
3. Allowed positive control of all elements.
4. Accomplished the mission quickly without unnecessary or prolonged exposure to enemy fire.

---

##### Performance Steps

1. Select the route that makes the best use of terrain.
-

---

**Performance Steps**

---

a. Your platoon spends more time moving than fighting in combat. Because a moving unit usually contacts the enemy at a time and place of the enemy's choosing, you must use terrain to your best advantage. Proper use of terrain has two advantages:

- (1) Cover and concealment to protect the platoon during movement.
- (2) Maximum effectiveness of the platoon's weapons.

b. To properly use those advantages, you must understand the military aspects of terrain and be able to apply them to any given situation, whether it be a defense, a delay, or a road march behind the forward edge of the battle area (FEBA).

c. The primary requirement for any type of movement on the battlefield is cover and concealment.

(1) Cover is any type of shielding from the effects of weapon fire, especially direct fire. You must take advantage of every ravine or depression in the ground to protect and cover your force, especially if you are forward of the FEBA. You must evaluate the terrain, the abilities of the enemy's weapons systems, and the position of known or suspected enemy emplacement. Visualize a cross section of the terrain and determine where the enemy cannot place effective direct fire on your proposed route.

(2) Concealment is anything that hides or disguises your force. You must consider concealment from both air and ground observation. If you are mechanized, exhaust smoke or dust can reveal your unit to the enemy.

d. If you are moving in an area where contact with the enemy is expected, you must ensure that your proposed route can be covered by fire from your overwatch or fire support positions. Those positions must have good observation and fields of fire.

(1) Direct fire weapons must have good observation to fire known or suspected enemy positions along your movement route. You must have observation to control the maneuver of your elements, if they make contact. Consider the effects of smoke and dust from friendly and enemy fire.

(2) Select a route that gives your unit the best field of fire. Your machine guns and antitank weapons must have good fields of fire to be effective. They must be in a position to provide suppressive fires immediately. The crew-served weapons to overwatching your movement must be able to observe your route and fire in your support all the way to the objective. The overwatch positions that you select must have unobstructed fields of fire to the next overwatch position.

---



---

**Performance Steps**

---

2. Select the route that provides the most favorable tactical advantage and meets the mission requirements. If enemy air is active or enemy ground forces are in the area of the route, you must take maximum advantage of cover and concealment. If speed of movement is critical, the route should be over the most easily negotiable terrain, avoiding difficult obstacles. The route should include movement from one easily distinguishable terrain feature to another. When ordered to move, you must check the terrain based on the above considerations and select the quickest and safest route.
  3. Planning a route can be aided by the use of special purpose maps and aerial photographs. If those aids are available, use them to ensure that you have the most current information.
  4. Map reconnaissance, however, is no substitute for ground reconnaissance. If time is available and the tactical situation permits, reconnoiter the route that you have to move over.
- 

**Evaluation Preparation:**

*Setup:* In a field environment, provide the soldier with a 1:50,000-scale military map of the area and a compass, and issue him an oral or written operation order.

*Brief Soldier:* Tell the soldier to select a route of movement between two given points (marked on the map) where the likelihood of enemy contact is unknown. The soldier must select a route that offers the best cover and concealment, ensure the best observation and fields of fire for support elements, allow positive control of elements, and accomplish the mission without unnecessary or prolonged exposure to enemy fire.

Performance Measures	GO	NO GO
1. Made a map reconnaissance of the area that must be moved over.	___	___
2. Selected a route that offered:	___	___
a. Maximum cover.		
b. Maximum concealment.		
c. Good observation to fire at known or suspected enemy positions along movement route.		
d. Best fields of fire.		
e. Most favorable tactical advantage.		
f. Positive control of all elements.		

**Evaluation Guidance:** Score the soldier GO if all performance measures are passed. Score the soldier NO GO if any performance measure is failed. If the soldier fails any performance measures, show him what was done wrong and how to do it correctly.

**References**

<b>Required</b>	<b>Related</b>
FM 7-7	
FM 7-8	

---

**Land Navigation Task 2**  
**Identify Topographic Symbols on a Military Map**

**Conditions:** Given a standard 1:50,000-scale military map.

**Standards:** Identified topographic symbols, colors, and marginal information on a military map with 100 percent accuracy.

---

**Performance Steps**

1. Identify the colors on a military map.
  - a. The ideal situation would be that every feature on that portion of the earth being mapped is shown on the map in its true shape and size. Unfortunately, that is impossible.
  - b. The amount of detail shown on a map increases or decreases, depending on its scale; for example, a map with a scale of 1:250,000.
  - c. Details are shown by topographic symbols. These symbols are shown using six basic colors as shown in table C-1.

---

Table C-1. Colors on a topographic map

<b>Colors</b>	<b>Symbols</b>
<b>Black</b>	Cultural (man-made) features other than roads
<b>Blue</b>	Water
<b>Brown</b>	All relief features—contour lines on old maps—cultivated land on red-light readable maps
<b>Green</b>	Vegetation
<b>Red</b>	Major roads, built-up areas, special features on old maps
<b>Red-Brown</b>	All relief features and main roads on red-light readable maps

- 
2. Identify the symbols used on a military map to represent physical features, such as physical surroundings or objects, as shown in table C-2.

---

**Performance Steps**

---

Table C-2. Features on topographic maps

FEATURES	COLORS	DESCRIPTION
Drainage	Blue	These symbols include lakes, streams, rivers, marshes, swamps, and coastal waters.
Relief	Brown	These features are normally shown by contour lines, intermediate contour lines, and form lines. In addition to contour lines, there are relief symbols to show cuts, levees, sand, sand dunes, ice fields, strip mines, and glaciers.
Vegetation	Green	These symbols include woods, scrub, orchards, vineyards, tropical grass, mangrove and marshy areas, or tundra.
Roads	Red, Black, or Red-brown	These symbols show hard-surface, heavy-duty roads; hard surface, medium-duty roads; improved light-duty roads; unimproved dirt roads; and trails. On foreign road maps, symbols may differ slightly; check the map legend for proper identification of roads.
Railroads	Black	These symbols show single-track railroads in operation; single-track railroads not in operation; double- or multiple-track railroads.
Buildings	Black, Yellow, Red, or Pink	These symbols show built-up areas, schools, churches, ruins, lighthouses, windmills, and cemeteries.

a. The shape of an object on the map usually tells what it is, for example, a black, solid square is a building or a house; a round or irregular blue item is a lake or pond.

b. Logic and what the colors mean must work together in determining a map feature. For example, blue represents water. If you see a symbol that is blue and has clumps of grass, this would be a swamp.

c. The size of the symbol shows the approximate size of an object. Most symbols are enlarged 6 to 10 times so that you can see them under dim light.

d. Use the legend; it has most of the symbols used on the map.

---

---

**Performance Steps**

---

3. Identify the marginal information found on the legend.
    - a. Marginal information at the top of the map sheet.
      - (1) The top left corner contains the geographic location of the map area and the scale of the map.
      - (2) The top center has the name of the map sheet.
      - (3) The top right corner contains the map edition, map series, and the map sheet number.
    - b. Marginal information at the bottom of the map sheet.
      - (1) The lower left corner of the map contains the legend, the name of the agency that prepared the map, the map sheet number, and the map sheet name.
      - (2) The bottom center contains the bar scales in meters, yards, miles, and nautical miles; the contour interval of the contour lines; the grid reference box; the declination diagram; and the G-M angle (mils or degrees).
      - (3) The lower right corner contains the elevation guide, the adjoining map sheet diagram, and the boundaries box, which shows any boundaries that may be on the map.
- 

**Evaluation Preparation:**

*Setup:* On a 1:50,000-scale military map, circle each item of marginal information found on the map. Randomly letter the circled items A through J. Circle an item or feature shown on the map by color. Randomly number each colored item 1 through 10. The items are listed in the Evaluation Guide/Performance Measures. Have a sheet of paper and two pencils available for the soldier being tested. For each soldier tested, provide a duplicate set of the map, paper, and pencils.

*Brief Soldier:* Tell the soldier to letter the paper A through J and 1 through 10. Tell the soldier to write down the name of the item contained in each lettered and numbered circle on the map.

<b>Performance Measures</b>	<b>GO</b>	<b>NO GO</b>
1. Identified the sheet name.	___	___
2. Identified the sheet number.	___	___
3. Identified the contour interval.	___	___
4. Identified the G-M angle (mils or degrees).	___	___

5. Identified the legend.	___	___
6. Identified the bar scales.	___	___
7. Identified the declination diagram.	___	___
8. Identified the grid reference box.	___	___
9. Identified the adjoining map sheets diagram.	___	___
10. Identified the elevation guide.	___	___
11. Identified 2 of 2 specific man-made features (shown in black on the map).	___	___
12. Identified 2 of 2 water features (blue on the map).	___	___
13. Identified 2 of 2 vegetation features (green on the map).	___	___
14. Identified 2 of 2 man-made features; for example, main roads or build-up areas (shown in brown or red-brown on the map).	___	___
15. Identified 2 of 2 contour lines (shown in brown or red-brown on the map).	___	___

**Evaluation Guidance:** Score the soldier GO if all performance measures are passed. Score the soldier NO GO if any performance measure is failed. If the soldier scores NO GO, show the soldier what was done wrong and how to do it correctly.

**References**

**Required**

FM 3-25.26

FM 21-31

**Related**

---

### Land Navigation Task 3

#### Identify Terrain Features on a Map

**Conditions:** Given a standard 1:50,000-scale military map.

**Standards:** Identified the five major and three minor features on the map.

---

#### Performance Steps

---

1. Identify terrain features in table C-3 in the same manner on all maps, regardless of the contour interval, but you must realize that a hill in the Rocky Mountains will be much bigger than the one in south Florida. You must be able to recognize all the terrain features to locate a point on the ground or to navigate from one point to another (figures C-3 through C-10).

**Note.** During instruction, demonstrate to the soldiers how they can learn terrain features using the fist and hand (figures C-1 and C-2). They can be used to show what each terrain feature would look like on the ground.

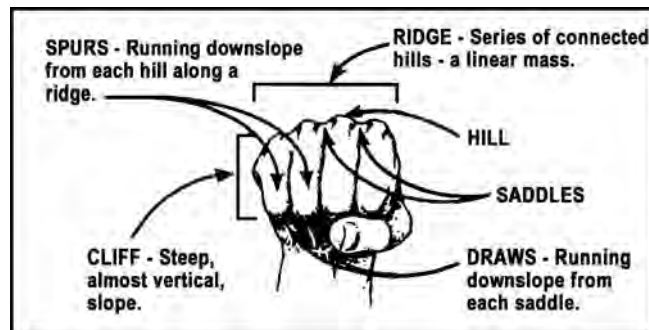


Figure C-1. Using fist to explain terrain features

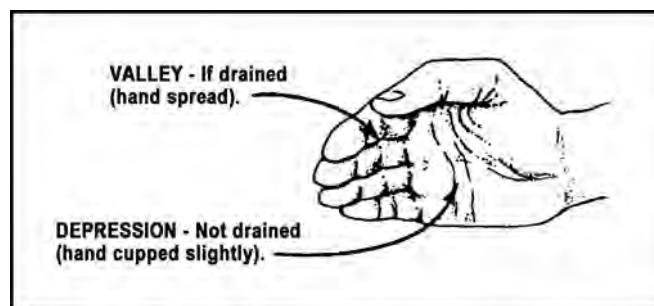


Figure C-2. Using hand to explain terrain features

---

---

**Performance Steps**

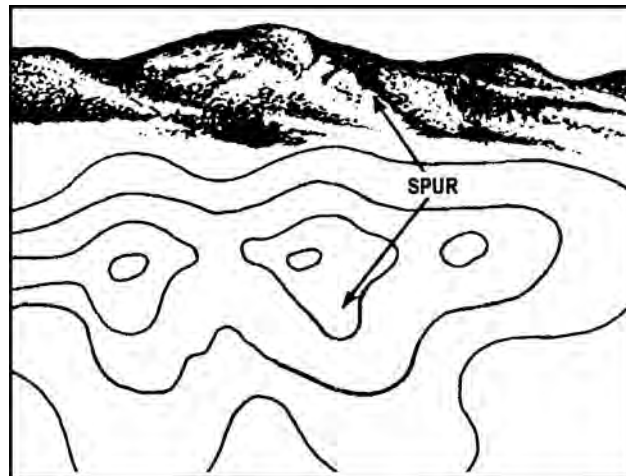
---

**Table C-3. Major and minor terrain features**

<b>FEATURE</b>	<b>CHARACTERISTICS</b>	<b>MAP SYMBOL</b>
Hill, Figure C-5, Major	A point or small area of high ground from which the ground slopes down in all directions.	Contour lines forming concentric circles.
Ridge, Figure C-6 Major	A line of high ground with height variations along its crest.	Contour lines forming a U or V; closed end points away from high ground.
Valley, Figure C-7, Major	Reasonably level ground bordered on the sides by higher ground. Generally has maneuver room. Contains a stream.	Contour lines form U. Lines tend to parallel stream before crossing. Contour line crossing a stream always points upstream.
Saddle, Figure C-8, Major	A dip/low point along a ridge crest; either lower ground between two hill tops or a break in the level crest.	A saddle is normally represented as an hourglass.
Depression, Figure C-9, Major	Low point or hole in the ground with higher ground on all sides.	Closed contour lines that have tick marks pointing toward low ground.
Draw, Figure C-10, Minor	Like a valley but normally has less developed stream course. No level ground and little or no maneuver room. Ground slopes upward on the sides and toward the head of the draw.	Contour lines are V-shaped with the point of the V toward the head of the draw (high ground).

**Performance Steps**

Table C-3. Major and minor terrain features		
FEATURE	CHARACTERISTICS	MAP SYMBOL
Spur, Figure C-3, Minor	Short, continuously sloping line of higher ground jutting out the side of a ridge. Often Table C-3. Major and minor terrain features (continued)formed by parallel streams cutting draws down a ridge.	Contour lines depict a spur with the U or V pointing away from higher ground.
Cliff, Figure C-4, Minor	A vertical or near vertical slope.	Contour lines are close together or a ticked or "carrying" contour line (ticks point to lower ground).



**Figure C-3. Spur**



---

Performance Steps

---

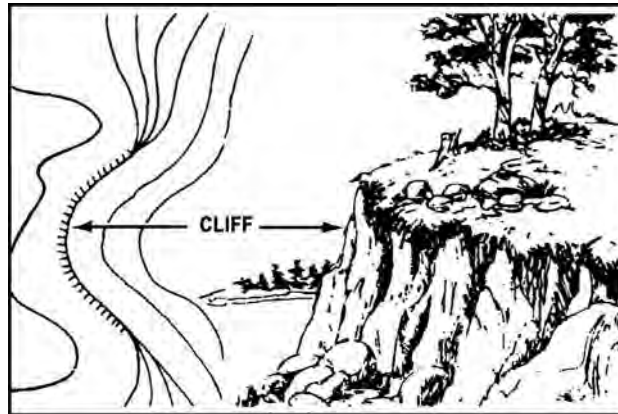


Figure C-4. Cliff

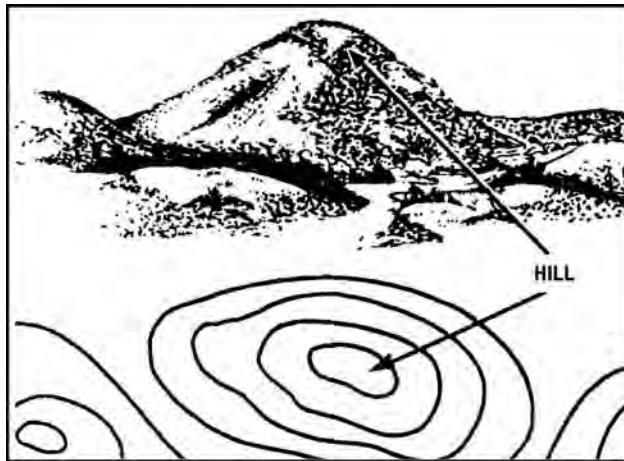


Figure C-5. Hill

---

Performance Steps

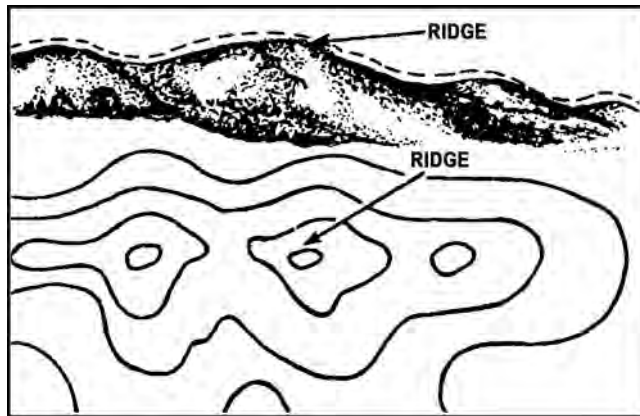


Figure C-6. Ridge

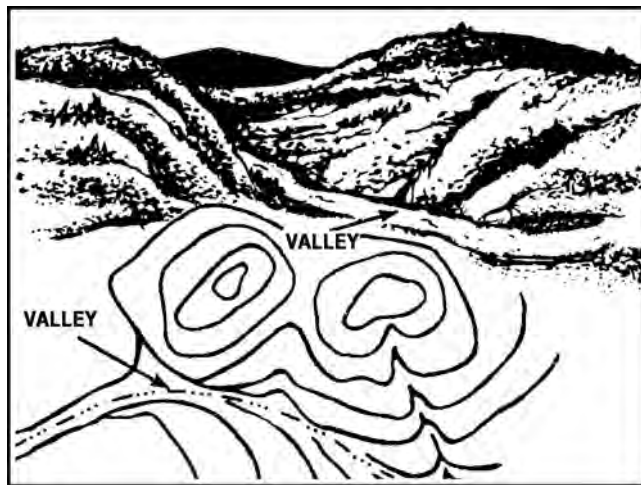


Figure C-7. Valley

---

Performance Steps

---

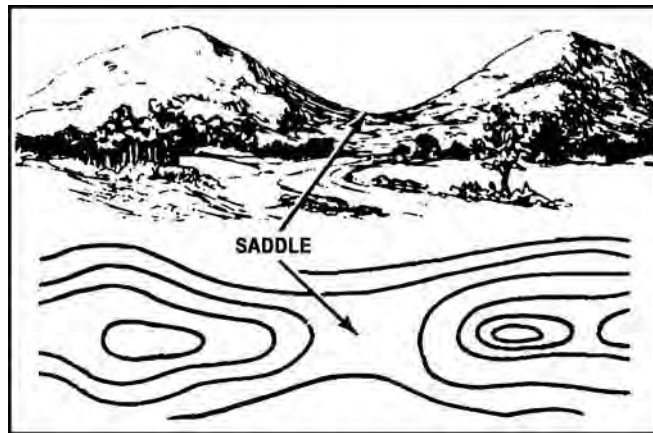


Figure C-8. Saddle

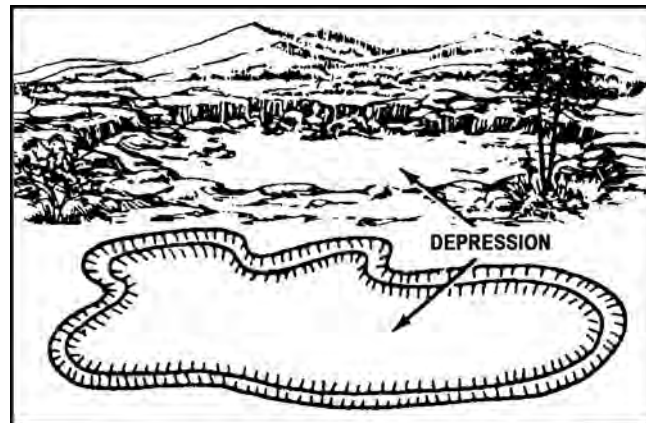


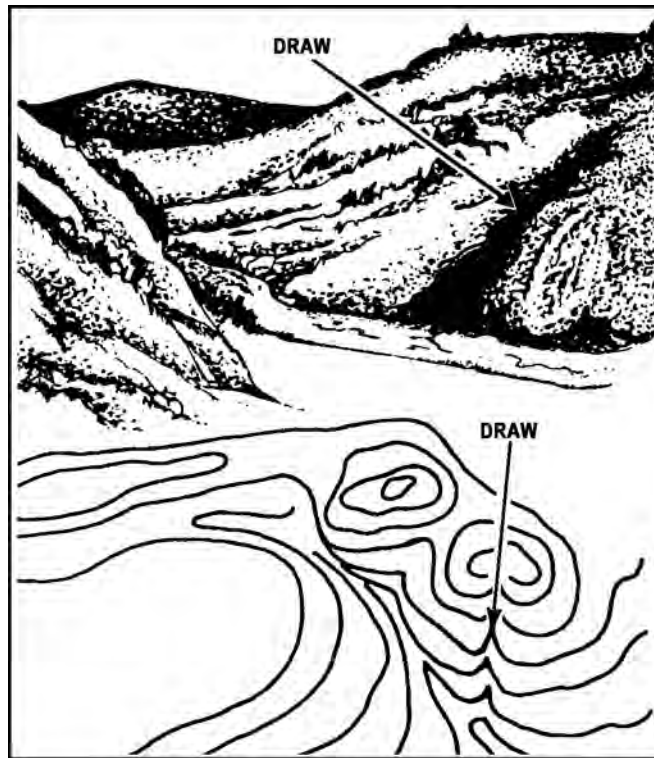
Figure C-9. Depression

---

---

**Performance Steps**

---



**Figure C-10. Draw**

---

**Evaluation Preparation:**

*Setup:* Use a 1:50,000-scale military map; circle one example of each major terrain feature and one example of each minor terrain feature. Randomly number the circled terrain features 1 through 8. Provide each soldier being tested with duplicate sets of the map, paper, and two pencils.

*Brief Soldier:* Tell the soldier to number the paper 1 through 8. Tell the soldier to write down the terrain feature that corresponds to each circled area on the map.

Performance Measures	GO	NO GO
1. Identified the following.	___	___
a. Hilltop.		
b. Ridge.		
c. Valley.		
d. Saddle.		
e. Depression.		
f. Draw.		
g. Spur.		
h. Cliff.		

**Evaluation Guidance:** Score the soldier GO if all performance measures are passed. Score the soldier NO GO if any performance measure is failed. If the soldier scores NO GO, show the soldier what was done wrong and how to do it correctly.

#### References

##### Required

FM 3-25.26

##### Related

---

## Land Navigation Task 4

### Determine the Grid Coordinates of a Point on a Military Map

**Conditions:** Given a standard 1:50,000-scale military map in a field location, a 1:50,000 grid coordinate scale, a pencil, paper, and a point on the map for which coordinates must be determined.

**Standards:** Determined the six-digit grid coordinates for the point on the map with a 100-meter tolerance. Recorded the grid coordinates with the correct two-letter 100,000-meter-square identifier.

---

#### Performance Steps

##### Note.

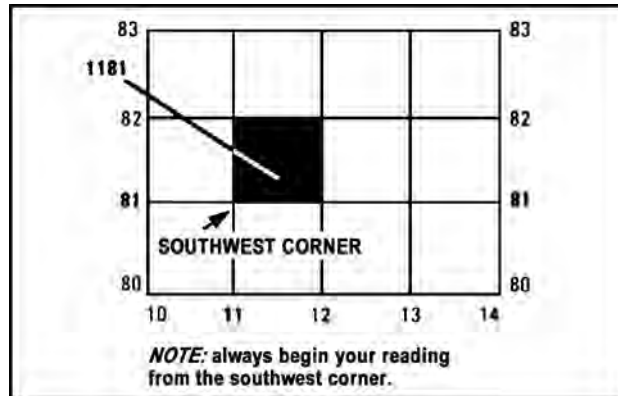
1. A military map can help you spot your location accurately. The map has vertical lines (top to bottom) and horizontal lines (left to right). These lines form small squares 1,000 meters on each side, called grid squares.
  2. The lines that form grid squares are numbered along the outside edge of the map picture. No two grid squares have the same number.
  3. The precision of a point location is shown by the number of digits in the coordinates; the more digits, the more precise the location. For example: 1996—A 1,000-meter grid square. 192961—To the nearest 100 meters.
-

---

**Performance Steps**

---

1. Look at figure C-11. Your address is grid square 1181. To determine your address, start from the left and read right until you come to 11, the first half of your address. Then read up to 81, the other half. Your address is somewhere in grid square 1181.



**Figure C-11. Grid square 1181**

2. Determine your address to the nearest 100 meters. Grid square 1181 gives your general neighborhood, but there is a lot of ground inside that grid square. To make your address more accurate, just add another number to the first half and another number to the other half so your address has six numbers instead of four.

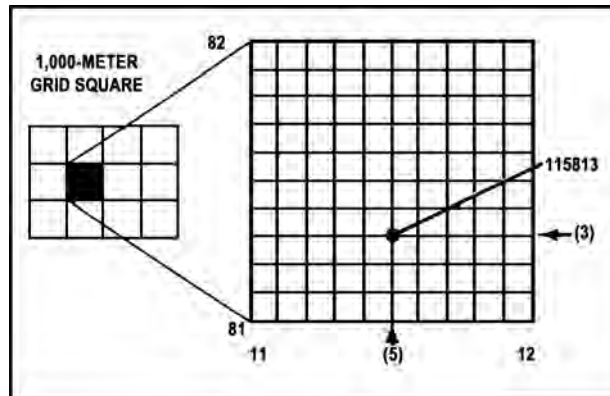
a. To get these extra numbers, suppose that each grid square has 10 lines inside it running north and south, and another 10 running east and west. This makes 100 smaller squares. You can estimate where these imaginary lines are (figure C-12).

---

---

**Performance Steps**

---



**Figure C-12. Grid square 1181 divided**

b. Suppose you are halfway between grid line 11 and grid line 12. Then the next number is 5 and the first half of your address is 115. Now suppose you are also 3/10 of the way between grid line 81 and grid line 82. Then the second half of your address is 813. Your address would be 115813 (figure C-12). (If you are exactly on line 81, the second half would be 810.)

3. Use a coordinate scale. The most accurate way to determine the coordinates of a point on a map is to use a coordinate scale. You do not have to use imaginary lines because you can come up with the exact coordinates. This scale is on the coordinate scale and protractor (GTA 05-02-012) (figure C-13) or the plotting scale (figure C-14). Both of these devices include two coordinate scales, 1:25,000 and 1:50,000 meters. Make sure that when you use either of these devices, you use the correct scale.

---

Performance Steps

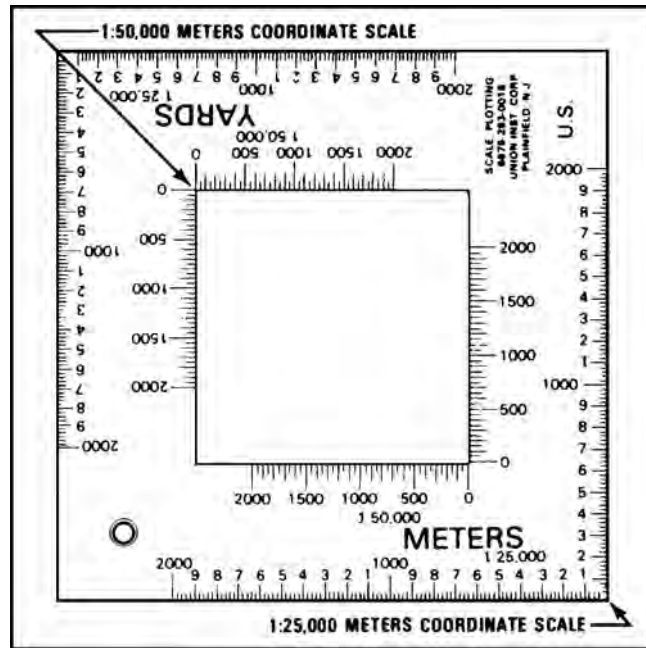


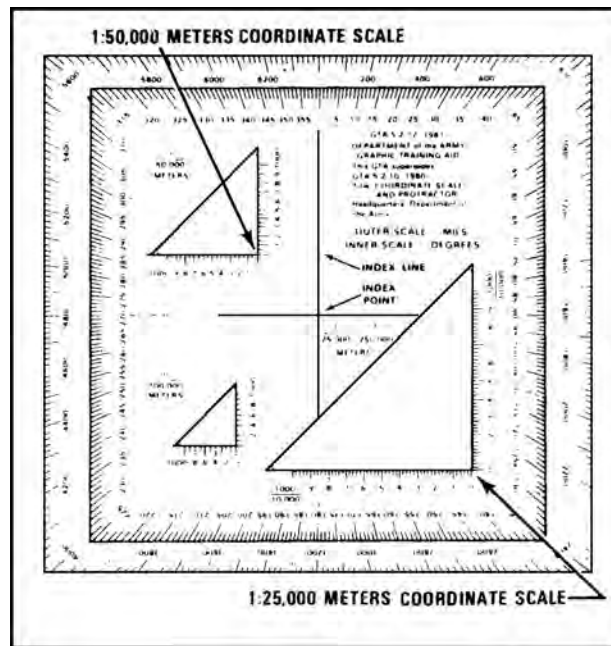
Figure C-13. Coordinate scale and protractor



---

**Performance Steps**

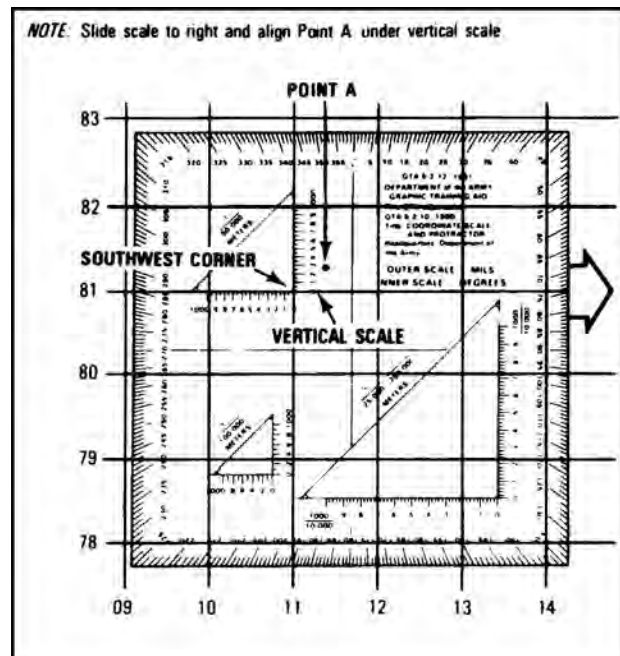
---



**Figure C-14. Plotting scale**

- a. Locate the grid square in which the point is located (for example, point A, figure C-15) (the point should already be plotted on the map).
  - b. The number of the vertical grid line on the left (west) side of the grid square gives the first and second digits of the coordinate.
  - c. The number of the horizontal grid line on the bottom (south) side of the grid square gives the fourth and fifth digits of the coordinate.
  - d. Place a coordinate scale on the bottom horizontal grid line of the grid square containing point A to determine the third and sixth digits of the coordinate.
  - e. Check to see that the zeros of the coordinate scale are in the lower left-hand (southwest) corner of the grid square where point A is located (figure C-15).
-

### Performance Steps



**Figure C-15. Placement of the coordinate scale**

f. Slide the scale to the right, keeping the bottom of the scale on the bottom grid line until point A is under the vertical (right-hand) scale (figures C-16 and C-17). To determine the six-digit coordinate, the 100-meter mark on the bottom scale, which is nearest the vertical grid line, is the third digit of the number 115. The 100-meter mark on the vertical scale, which is nearest point A, is the sixth digit of the number 813. Putting these together, you have 115813.

Performance Steps

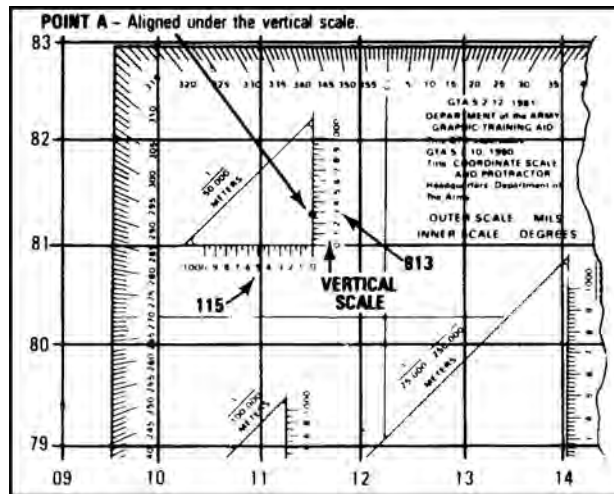


Figure C-16. Aligning the coordinate scale

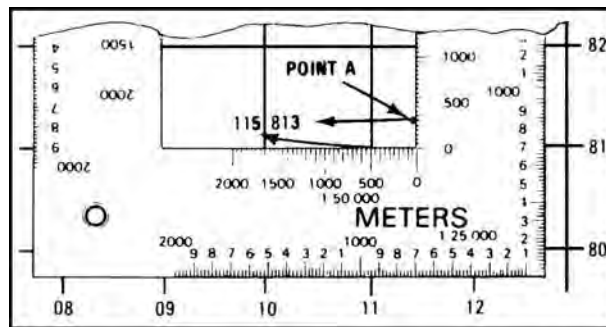
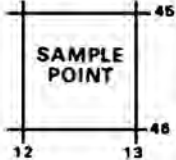



Figure C-17. Aligning the plotting scale

g. To determine the correct two-letter 100,000-meter-square identifier, look at the grid reference box in the margin of the map (figure C-18).

**Performance Steps**

<p><b>SAMPLE 1,000-METER GRID SQUARE</b></p> 	<p><b>100-METER REFERENCE</b></p> <p>1. READ LARGE NUMBERS LABELING THE VERTICAL GRID LINE LEFT OF POINT AND ESTIMATE TENTHS (100 METERS) FROM GRID LINE TO POINT.</p> <p>2. READ LARGE NUMBERS LABELING THE HORIZONTAL GRID LINE BELOW POINT AND ESTIMATE TENTHS (100 METERS) FROM GRID LINE TO POINT.</p> <p><b>EXAMPLE: 123456</b></p>
<p><b>100,000-METER SQUARE IDENTIFICATION</b></p> 	<p>WHEN REPORTING ACROSS A 100,000-METER LINE, PREFIX THE 100,000-METER SQUARE IDENTIFICATION IN WHICH THE POINT LIES</p> <p><b>EXAMPLE: FL123456</b></p>
<p><b>GRID ZONE DESIGNATION</b></p> <p><b>16S</b></p>	<p>WHEN REPORTING OUTSIDE THE GRID ZONE DESIGNATION AREA, PREFIX THE GRID ZONE DESIGNATION.</p> <p><b>EXAMPLE: 16SFL123456</b></p>

**Figure C-18. Grid reference box**

h. Place the 100,000-meter-square identifier in front of the coordinate, GL115813.

**Evaluation Preparation:**

*Setup:* Give the soldier a standard 1:50,000-scale military map in a field location, a 1:50,000 grid coordinate scale, a pencil, paper, and a point on a map for which coordinates must be determined.

*Brief Soldier:* Tell the soldier to write down the two-letter 100,000-meter-square identifier and the six-digit grid coordinates for one point and the two-letter 100,000-meter-square identifier.

Performance Measures	GO	NO GO
1. Determined the six-digit grid coordinates for the point on the map with a 100-meter tolerance.	___	___
2. Recorded the grid coordinates with the correct two-letter 100,000-meter-square identifier.	___	___

**Evaluation Guidance:** Score the soldier GO if all performance measures are passed. Score the soldier NO GO if any performance measure is failed. If the soldier scores NO GO, show the soldier what was done wrong and how to do it correctly.

#### References

**Required**

FM 3-25.26

GTA 05-02-012

**Related**

---

## Land Navigation Task 5

### Determine a Magnetic Azimuth Using a Lensatic Compass

**Conditions:** Given a compass and a designated point on the ground.

**Standards:** Determined the correct magnetic azimuth to the designated point within three degrees using the compass-to-cheek method, and within ten degrees using the center-hold method.

---

#### Performance Steps

1. Read your compass (figure C-19).

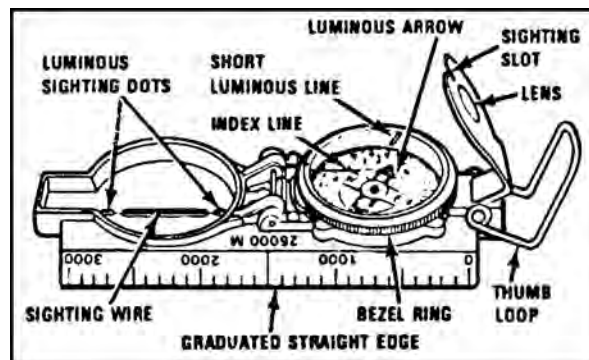


Figure C-19. Lensatic compass

- a. The floating dial is used to determine the direction in which you are pointing your compass.
- b. The outer, black ring of numbers and tick marks are used for finding direction in mils (figure C-20).

---

### Performance Steps

---

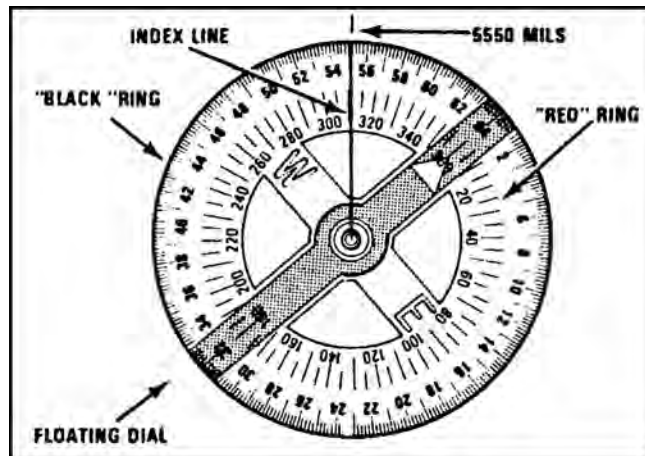


Figure C-20. Lensatic compass floating dial

c. The inner, red ring of numbers and tick marks are used for finding direction in degrees.

(1) There are 360 degrees or 6400 mils in a circle. These are marked with a tick mark every 5 degrees or 20 mils. However, not every tick mark is numbered. You will have to determine the number for these lines using the numbers that are shown.

(2) To read direction, point the compass in the direction you want to go or want to determine.

(3) Look beneath the index line on the outer glass cover and estimate to the nearest degree or 10 mils the position of the index line over the red or black scale.

(4) Be careful to hold the compass still so that the dial remains stationary while you are reading the scale.

(5) If you understand these readings and can apply either of the holding and sighting techniques of shooting an azimuth, you will be proficient in performing this task.

2. Shoot an azimuth.

a. Use your compass to determine or follow an azimuth. The arrow on the compass points toward magnetic north. The arrow is also attracted by any mass of metal; for example, a truck, your rifle, your helmet, and even electrical power lines. Thus, be sure you use your compass away from metal objects so it will not give a wrong reading.

---

---

**Performance Steps**

---

b. The lensatic compass must always be held level and firm when sighting on an object and reading an azimuth.

c. There are two methods of holding the lensatic compass and sighting.

(1) Compass-to-cheek method (figure C-21). To use this method—

(a) Open the cover to a 90-degree angle to the base. Position the eyepiece at a 45-degree angle to the base.

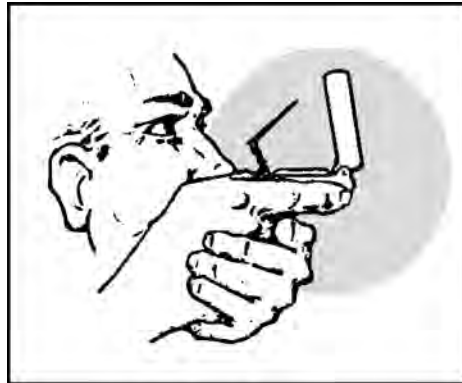
(b) Place your thumb through the thumb loop, form a steady base with your third and fourth fingers, and extend your index finger along the side of the compass base.

(c) Place the hand holding the compass into the palm of the other hand.

(d) Bring both hands up to your face and position the thumb that is through the thumb loop against the cheekbone.

(e) Look through the lens of the eyepiece. If the dial is not in focus, move the eyepiece up or down until the dial is in focus.

(f) Align the sighting slot of the eyepiece with the sighting wire in the cover on the point for which the azimuth is being determined. Look through the lens of the eyepiece and read the azimuth under the index line.



**Figure C-21 Compass -to-cheek method**

---

(2) Center-hold method (figure C-22). To use this method—

---

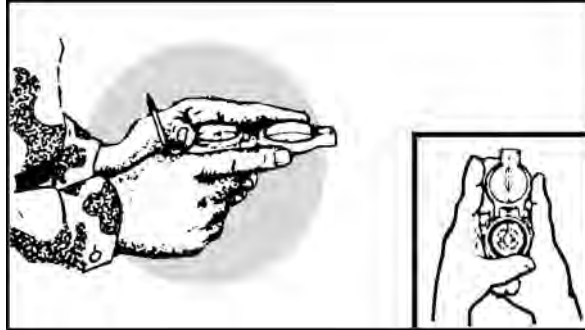
---

**Performance Steps**

---

**Note.** This method is used only when a precise direction is not required.

---



**Figure C-22. Center-hold method**

---

(a) Open the compass so that the cover forms a straight edge with the base. The lens of the compass is moved out of the way.

(b) Next, place your thumb through the loop, form a steady base with your third and fourth fingers, and extend your index finger along the side of the compass.

(c) Place the thumb of the other hand between the eyepiece and lens, extend the index finger along the remaining side of the compass, wrap the remaining fingers around the fingers of the other hand, and pull your elbows firmly into your side. This will place the compass between your chin and your belt.

(d) To measure an azimuth, turn your entire body toward the object and point the compass cover directly at the object. Look down and read the azimuth from beneath the fixed black index line. This method can be used at night.

(e) To keep from going in circles when you are land navigating, stop occasionally to check the azimuth along which you are moving. Also, you can move from object to object along your path by shooting an azimuth to each object and then moving to that object. Repeating this process while you navigate should keep you straight.

---

**Evaluation Preparation:**

*Setup:* Select a point to use as a target and determine the azimuth to the point using the compass that the soldier will use.

*Brief Soldier:* Point out the selected spot to the soldier. Tell the soldier to shoot an azimuth to that spot using both the compass-to-cheek method and the center-hold method.



Performance Measures	GO	NO GO
1. Determined the correct magnetic azimuth to the designated point within 3 degrees using the compass-to-cheek method.	—	—
2. Determined the correct magnetic azimuth to the designated point within 10 degrees using the center-hold method.	—	—

**Evaluation Guidance:** Score the soldier GO if all performance measures are passed. Score the soldier NO GO if any performance measure is failed. If the soldier scores NO GO, show the soldier what was done wrong and how to do it correctly.

**References**

**Required**  
FM 3-25.26

**Related**

---

## Land Navigation Task 6

### Determine the Elevation of a Point on the Ground Using a Map

**Conditions:** Given a standard 1:50,000 scale military map, a pencil, and a designated point on the map.

**Standards:** Determined the elevation of the designated point to within half the value of the contour interval.

---

#### Performance Steps

---

1. Locate contour lines and contour intervals.
    - a. The brown lines on the map are called contour lines. Each line shows the height above sea level. Contour lines never cross one another. Printed at the bottom of the map is the contour interval, which is the difference in height (elevation) between one brown line and the one on either side of it. On a map with a scale of 1:50,000, the contour interval is usually 20 meters. This would make point A 80 meters higher or lower than point B (figure C-23).
- 

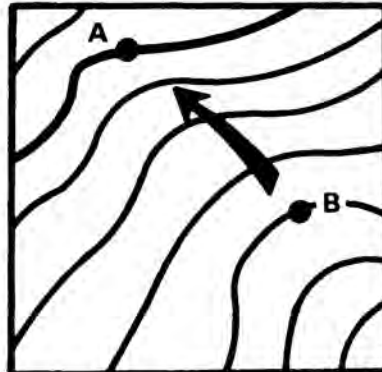


Figure C-23. Contour lines

---

---

**Performance Steps**

---

b. You can easily tell from the brown lines the direction of uphill or downhill because every fifth line is heavier and has a number that gives its elevation. Let's say the contour interval is 20 meters again. Now you can tell that point B. Also, if you know the distance between A and B, you can get an idea of the steepness of the slope (figure C-24).

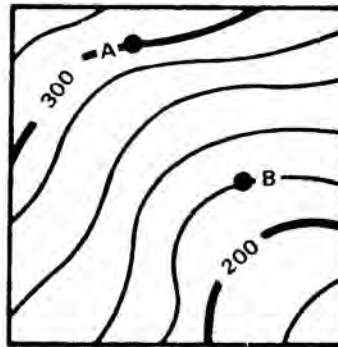


Figure C-24. Contour intervals

c. Widely spaced contour lines show a gentle slope. When they are close together, the slope is steep (figure C-25).

---

Performance Steps

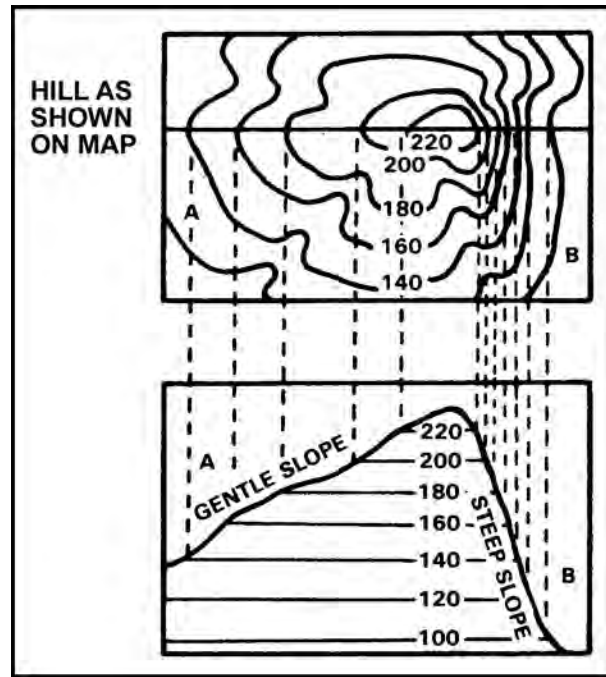


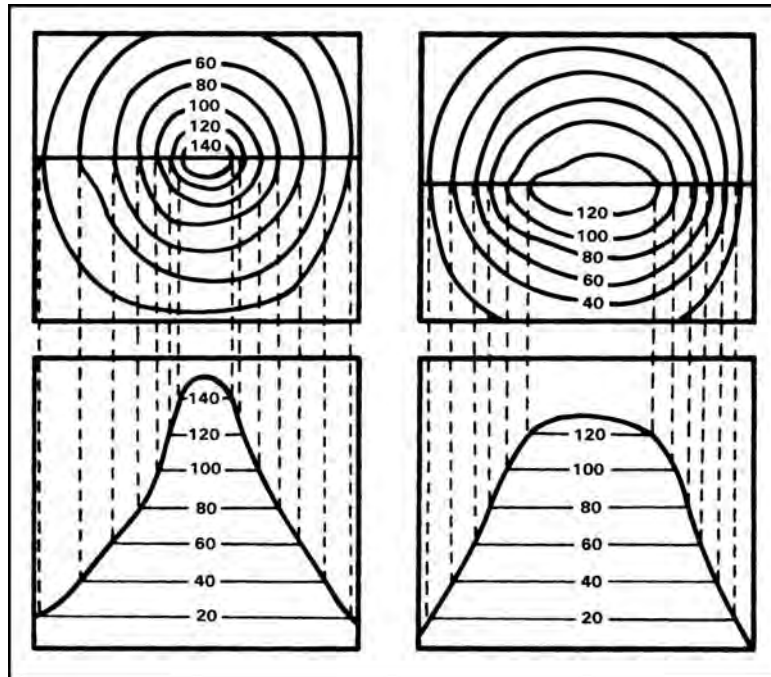
Figure C-25. Slope

d. When the contour lines are close together at the top of the hill, the hilltop is pointed. When the contour lines are widely spaced, the hilltop is flat (figure C-26).

---

**Performance Steps**

---



**Figure C-26. Elevation**

2. Determine elevation.
    - a. Locate the point on the map. (It may already be plotted on the map, or given as eight-digit coordinates).
    - b. Determine the contour interval of the map from the marginal information.
    - c. Locate the index contour line nearest the point for which the elevation is being sought.
    - d. Count the number of contour lines, up or down, that must be crossed to go from the numbered lines to the point, and note the direction to the point. If the point is on a contour line, its elevation is that of the contour line. For points between contour lines—
      - (1) Points less than one-fourth the distance between lines are considered to be the same as the elevation of the nearest line.
-

---

**Performance Steps**

---

(2) Point one-fourth to three-fourths the distance from the lower line are considered to be at an elevation half the contour interval above the lower line.

e. To estimate the elevation of the top of an unmarked hill, add half the contour interval to the elevation of the highest contour line around the hill.

f. To estimate the elevation of the bottom of depression, subtract half the contour interval from the elevation of the lowest contour around the depression.

g. On maps that do not show elevation and relief as much detail as needed, supplementary contour lines may be used. Marginal information indicates the interval, and the supplementary lines are used exactly like solid contour lines.

h. Benchmarks and spot elevation also indicate points of known elevation.

---

**Evaluation Preparation:**

*Setup:* Provide the soldier with a 1:50,000 scale military map, a designated point on the map labeled "A", and a pencil.

*Brief Soldier:* Tell the soldier to determine the elevation of the point that is labeled "A" on the map.

<b>Performance Measures</b>	<b><u>GO</u></b>	<b><u>NO GO</u></b>
1. Determined the correct elevation within half the value of the contour interval.	—	—
<b>Note.</b> If the contour interval of the map is in feet, the answer must be in feet. If the contour interval is in meters, the answer must be in meters.		

**Evaluation Guidance:** Score the soldier GO if the performance measure is passed. Score the soldier NO GO if the performance measure is failed. If the soldier scores NO GO, show what was done wrong and how to do it correctly.

**References****Required**

FM 3-25.26

**Related**

---

## Land Navigation Task 7

### Determine a Location on the Ground by Terrain Association

**Conditions:** In the field during daylight, while at an unknown location on the ground, given a standard 1:50,000-scale military map of the area, pencil, paper, a coordinate scale, protractor, and a known point on the ground.

**Standards:** Determined the six-digit coordinate of your location with a 100-meter tolerance within seven minutes.

---

#### Performance Steps

---

1. Determine the type of terrain feature upon which you are located. (See task number 071-329-100, Identify Terrain Features On A Map.)
  2. Determine what types of terrain features surround your location.
  3. Orient the map. (See task number 071-329-1012, Orient A Map To The Ground By Map Terrain Association.)
  4. Determine the four cardinal directions (north, south, east, and west). (See task number 071-329-1002, Determine The Grid Coordinates Of A Point On A Military Map.)
  5. Determine your location.
    - a. Relate the terrain features on the ground to those shown on the map.
    - b. After you have determined where the terrain features on the ground and those on the map coincide, determine the coordinates of your location using the coordinate scale and protractor.
- 

#### Evaluation Preparation:

*Setup:* Select a field site that has terrain features that are shown on the map. At the test site, provide a field table, a 1:50,000-scale military map of the area, pencil, paper, and a coordinate scale.

*Brief Soldier:* Tell the soldier he or she must determine a six-digit coordinate of his or her location within 7 minutes. Tell the soldier one of the cardinal directions (north, south, east, or west).

Performance Measures	GO	NO GO
1. Identified the type of terrain feature upon which you were located.	___	___
2. Identified the terrain features around your location.	___	___
3. Oriented the map.	___	___

Performance Measures	GO	NO GO
4. Determined the remaining three cardinal directions.	___	___
5. Identified the same terrain features on the map.	___	___
6. Determined the six-digit grid coordinate of your own location (the point selected must be within 100 meters of your location).	___	___

**Evaluation Guidance:** Score the soldier GO if all performance measures are passed. Score the soldier NO GO if any performance measure is failed. If the soldier scores NO GO, show the soldier what was done wrong and how to do it correctly.

#### References

##### Required

FM 3-25.26

##### Related

---

## Land Navigation Task 8

### Measure Distance on a Map

**Conditions:** Given a standard 1:50,000-scale military map, a strip of paper with a straight edge, and a pencil.

#### Standards:

1. Determined the straight-line distance, in meters, between two points, with no more than five percent error.
2. Determined the road (curved line) distance, in meters, between two points, with no more than ten percent error.

---

#### Performance Steps

1. Identify the scale of the map. The map scale is the ratio (1:50,000) of the distance on the map (1 inch) compared to the distance on the ground (usually 50,000 inches).
  2. Convert a straight-line map distance to miles, meters, or yards using the map's bar scale (figure C-27).
-



---

### Performance Steps

---

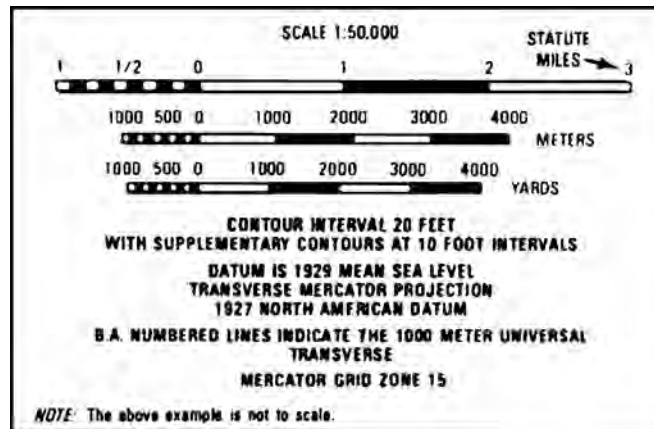


Figure C-27. Bar scales

a. For map distances equal to or less than one inch:

- (1) Line up the straight edge of a strip of paper with the beginning and ending points on the map.
- (2) Mark on the straight edge of the paper the beginning and ending points (figure C-28).

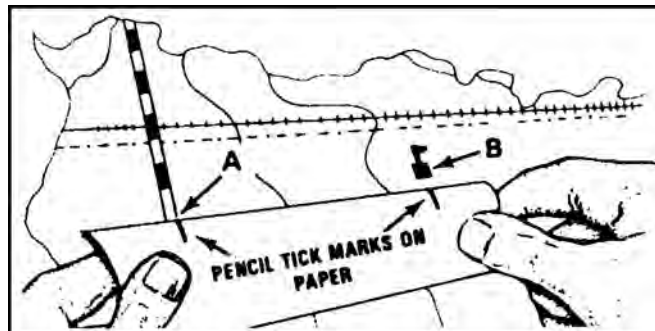


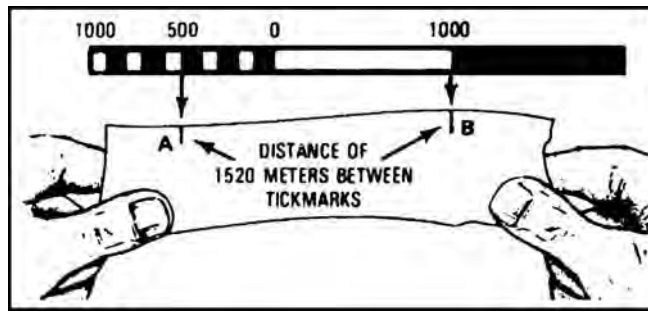
Figure C-28. Measuring distance

- (3) Match the marks on the paper with the appropriate bar scale (figure C-29).
-

---

**Performance Steps**

---



**Figure C-29. Determining distance**

- (4) Determine the distance on the scale that compares to the distance on the paper.
    - b. For map distances greater than one inch:
      - (1) Line up the straight edge of a strip of paper with the beginning and ending points on the map.
      - (2) Mark the beginning and ending points on the straight edge of the paper (figure C-28).
      - (3) Place the starting point on the paper under the zero on the bar scale.
      - (4) Measure off 4,000 meters and place a new tick mark on the paper.
      - (5) Place the new tick mark under the zero on the bar scale.
      - (6) Determine if the end point falls within the bar scale.
        - (a) Record the value on the scale of the end point if the end point fits on the scale.
        - (b) Add 4,000 meters to the value you derived in step 2b(6)(a). This is the total difference.
      - (7) Determine if the end point does not fall within the bar.
        - (a) Repeat steps 2b(4) and (5) until the end point falls within the bar.
        - (b) Add 4,000 meters to the value you derived in step 2b(6)(a) for each time you performed step 2b(4). This is the total difference.
  3. Convert a road map distance to miles, meters, or yards using the map's bar scale (figure C-28). This is the actual distance you have to travel to reach the point whose straight line distance you identified in step 2.
-

---

**Performance Steps**

---

- a. Line up the straight edge of a strip of paper with the beginning point and the point at which the road makes the first curve on the map.
  - b. Mark on the straight edge of the paper the beginning and curve points (figure 27).
  - c. Repeat steps 3a and b (each time using the point of the curve as the next beginning point) until you reach the end point.
  - d. Use step 3 to determine the road distance in miles, meters, or yards as appropriate.
    - (1) If the total distance measured on the paper is equal to or less than 1 inch, use steps 2a(3) and (4).
    - (2) If the total distance measured on the paper is more than 1 inch, use steps 2b(3) through (7).
- 

**Evaluation Preparation:**

*Setup:* In the field or classroom, give the soldier a 1:50,000-scale military map, a strip of paper with a straight edge, and a pencil. On the map, plot a straight-line distance of 3,000 to 4,000 meters. Mark this distance points A and B. On a road or trail, plot a curved-line distance of 3,000 to 4,000 meters with at least two changes of direction. Mark this distance points C and D.

*Brief Soldier:* Tell the soldier that he or she must determine the straight-line distance between points A and B with no more than 5 percent error, and the curved-line distance between points C and D with no more than 10 percent error. He or she must either write down the correct answers or state the answers when asked by the scorer.

Performance Measures	GO	NO GO
1. Identified the scale of the map.	___	___
2. Converted the straight-line map distance to miles, meters or yards using the map's bar scale with no more than 5 percent error.	___	___
3. Converted the road map distance to miles, meters, or yards using the map's bar scale with no more than 10 percent error.	___	___

**Evaluation Guidance:** Score the soldier GO if all performance measures are passed. Score the soldier NO GO if any performance measure is failed. If the soldier scores NO GO, show the soldier what was done wrong and how to do it correctly.

## References

### Required

FM 3-25.26

### Related

---

## Land Navigation Task 9

### Convert Azimuths

**Conditions:** Given a standard 1:50,000-scale military map with a declination diagram, a pencil, and a magnetic azimuth and a grid azimuth that must be converted.

**Standards:** Converted the given magnetic azimuth to a grid azimuth and the given grid azimuth to a magnetic azimuth without error.

---

### Performance Steps

1. The north-south lines on your map give grid north. The needle of your compass points to magnetic north. Grid north and magnetic north are usually different by a few degrees. Neither one points straight to the North Pole (called true north), but you do not need to know true north to keep from getting lost in a combat area. The difference in degrees for every map is shown on the bottom of mapsheet (figure C-30).

---

---

Performance Steps

---

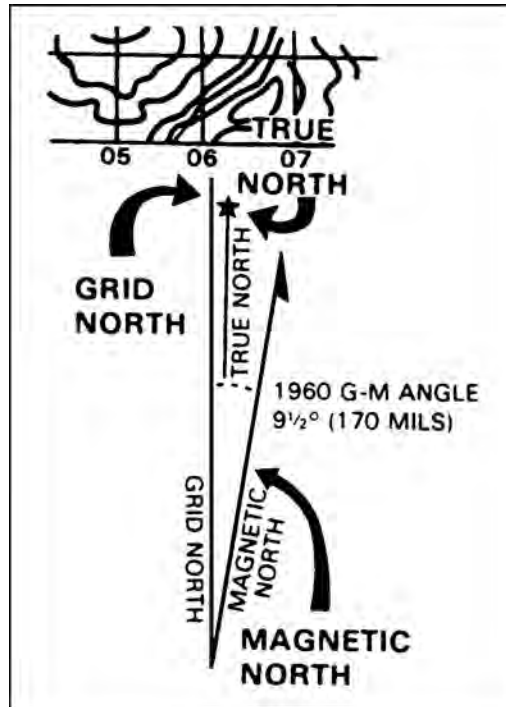


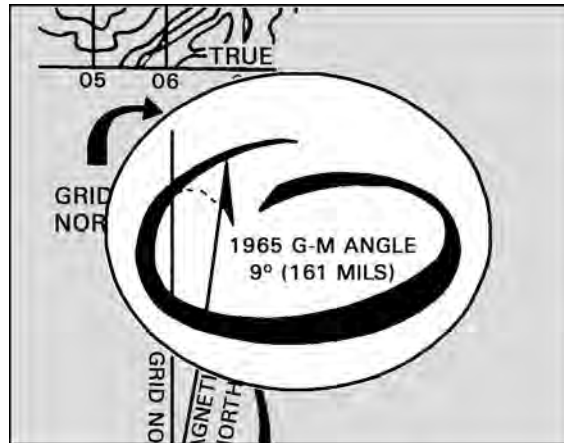
Figure C-30. Declination diagram

2. The difference between grid north and magnetic north is called the grid-magnetic (G-M) angle. The diagram at the bottom of the map tells you how to change grid azimuths to magnetic azimuths and magnetic azimuths to grid azimuths (figure C-31).
-

---

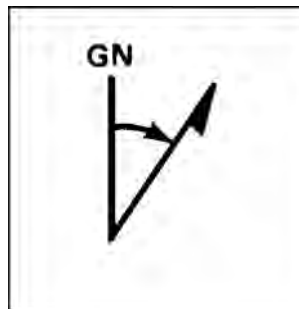
**Performance Steps**

---



**Figure C-31. G-M angle**

3. For example, you aim your compass at a distant point. The compass reading you get is 190 degrees, the magnetic azimuth. The diagram on your map (see figure 2) tells you that the G-M angle is 9 degrees, and it also tell you that "to convert a magnetic azimuth to a grid azimuth, add the G-M angle." Therefore add 9 degrees to your compass reading. This gives you  $190 + 9 = 199$ . Your grid azimuth is 199 degrees.
4. The G-M angle depends on where you are in the world.
5. Convert azimuths when given an easterly G-M angle (figure C-32).



**Figure C-32. Converting azimuths with easterly G-M angle**

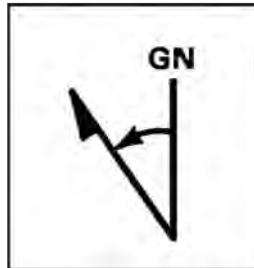
- a. To convert a magnetic azimuth to a grid azimuth, add the value of the G-M angle to the magnetic azimuth.
-

---

**Performance Steps**

---

- b. To convert a grid azimuth to a magnetic azimuth, subtract the G-M angle from the grid azimuth.
6. Convert azimuths when given a westerly G-M angle (figure C-33).



**Figure C-33. Converting azimuths with westerly G-M angle**

- a. To convert a magnetic azimuth to a grid azimuth, subtract the value of the G-M angle from the magnetic azimuths.
  - b. To convert a grid azimuth to a magnetic azimuth, add the value of the G-M angle to the grid azimuth.
- 

**Evaluation Preparation:**

*Setup:* Give the soldier a standard 1:50,000-scale military map, a piece of paper, a pencil, and a magnetic and grid azimuth to be converted.

*Brief Soldier:* Tell the soldier to convert the magnetic azimuth to a grid azimuth and the grid azimuth to a magnetic azimuth.

<b>Performance Measures</b>	<b>GO</b>	<b>NO GO</b>
1. Determined correct grid azimuth.	___	___
2. Determined correct magnetic azimuth.	___	___

**Evaluation Guidance:** Score the soldier GO if all performance measures are passed. Score the soldier NO GO if any performance measure is failed. If the soldier scores NO GO, show what was done wrong and how to do it correctly.

**References**

**Required**

FM 3-25.26

**Related**

---

## Land Navigation Task 10

### Orient a Map Using a Lensatic Compass

**Conditions:** Given a field table, a standard 1:50,000-scale military map, a protector, a pencil, paper, and a compass in daylight.

**Standards:** Oriented the map to the ground using a compass so the north-seeking arrow of the compass was within 3 degrees (20 mils) of the angle shown in the grid-magnetic (G-M) angle of the declination diagram shown on the map.

---

#### Performance Steps

1. With the map level, place the compass parallel to a north-south grid line with the cover side of the compass pointing towards the top of the map. This will place the black index line on the dial of the compass parallel to grid north. Because the needle on the compass points to magnetic north, a declination diagram on the face of the compass is formed by the index line and the compass needle.
  2. Rotate map and compass until the directions of the declination diagram formed by the black index line and the compass needle match the direction shown in the declination diagram printed on the margin of the map. The map is then oriented.
  3. If the magnetic north arrow on the map is to the left of the grid north, the compass reading will equal the G-M angle (given the declination diagram). If the magnetic north is the right of the grid north, the compass reading will equal 360 degrees (6400 mils) minus the G-M angle.
  4. Remember to point the compass north arrow in the same direction as the magnetic north arrow (step 2 above), and the compass reading (equal to the G-M angle or the 360 degrees (6400 mils) minus G-M angle) will be quite apparent.
- Note.** If the G-M angle is less than 3 degrees (50 mils), do not line up the north arrow.
5. Some maps have a built-in protractor consisting of a pivot point "P" on the south neat line of the map and several degrees of arc along the north neat line of the map. The G-M line is obtained by connecting pivot "P" with the appropriate value of the G-M angle (taken from the declination diagram) on the arc. The map may then be oriented by placing the compass parallel on this line and rotating the map and compass until the needle point is aligned with the continuous line formed by the index line and the sighting wire. The map is then oriented.



---

**Performance Steps**

---

6. An alternate method is to draw a magnetic north line on the map from any N-S and E-W grid line intersection using the protractor. Align the straightedge of the compass along this magnetic north line and rotate the map and compass together until the north arrow falls beneath the fixed black index line on the compass.

---

**Evaluation Preparation:**

*Setup:* Select an area that is free of magnetic interference (parlance, vehicles). Provide a field table, 1:50,000-scale military map, a protractor, a pencil, paper, and a compass.

*Brief Soldier:* Tell the soldier to orient the map to the ground using the compass. Tell the soldier he must use the G-M angle shown by the declination diagram if it exceeds 3 degrees (50 mils).

<b>Performance Measures</b>	<b>GO</b>	<b>NO GO</b>
1. Determined whether G-M angle exceeds 3 degrees (50 mils)	—	—
2. Aligned the side of the compass with one of the north-south grid lines.	—	—
3. Positioned the cover of the compass toward the top of the map.	—	—
4. Oriented the map.	—	—
5. Corrected the orientations of the map when the G-M angle exceeded 3 degrees (50 mils) using one of the following:	—	—
a. Used the G-M angle formed by the compass' black index line and the compass needle.		
b. Used the pivot point "P" on the south neat line and the degrees of arc along the north neat line and placed the compass along this line.		
c. Drew a magnetic north line from any N-S and E-W grid the intersection using a protractor and placed the compass along this line.		
<b>Note.</b> Step 5 is required only when G-M angle exceeds 3 degrees or 50 mils. Step 5b is tested only if the map has the built-in protractor.		

**Evaluation Guidance:** Score the soldier GO if all performance measures are passed. Score the soldier NO GO if any performance measure is failed.

If the soldier scores NO GO, show what was done wrong and how to do it correctly.

#### References

##### Required

FM 3-25.26

##### Related

---

### Land Navigation Task 11

#### Orient a Map to the Ground by Map-Terrain Association

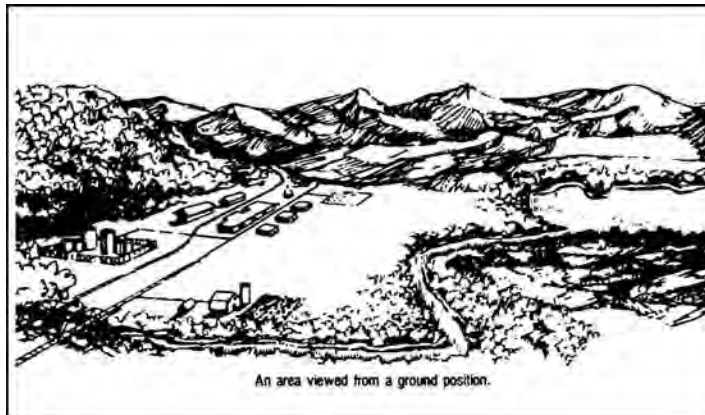
**Conditions:** Given a standard 1:50,000-scale military map in the field in daylight.

**Standards:** Oriented the map to within 30 degrees of north.

---

#### Performance Steps

1. Match terrain features appearing on the map with physical features on the ground (figure C-34).



**Figure C-34. Features used to orient map**

- a. Hold the map in a horizontal position.
  - b. Line up features on the ground with those on the map.
2. Check orientations obtained by this method by placing a compass along one of the north-south grid lines to keep from orienting the map in the wrong direction (that is, 180 degrees out) or by aligning two or more features. Incorporate the declination constant in determining the 30 degrees.

**Evaluation Preparation:**

*Setup:* Use an area of terrain with identifiable terrain features, natural and/or man-made. Provide a field table and a 1:50,000-scale map of the area.

*Brief Soldier:* Tell the soldier to use the terrain features around him or her, the soldier must orient the map to within 30 degrees of north.

Performance Measures	GO	NO GO
1. Matched terrain features by holding map in horizontal position and lining up features on the ground.	___	___
2. Checked orientations.	___	___

**Evaluation Guidance:** Score the soldier GO if all performance measures are passed. Score the soldier NO GO if any performance measure is failed. If the soldier scores NO GO, show the soldier what was done wrong and how to do it correctly.

**References****Required**

FM 3-25.26

**Related**

---

**Land Navigation Task 12****Locate an Unknown Point on a Map and on the Ground by Intersection**

**Conditions:** Given a standard 1:50,000-scale military map of the area, the location of two known points, a compass, a straight edge, a coordinate scale, a protractor (GTA 05-02-012), a pencil, and an object or terrain feature for which the soldier must determine the grid location.

**Standards:** Determined the 100,000-meter square identification letters and six-digit coordinates of the object or terrain feature to within 100 meters.

---

**Performance Steps**

1. Use the map and compass method (figure C-35).
-

Performance Steps

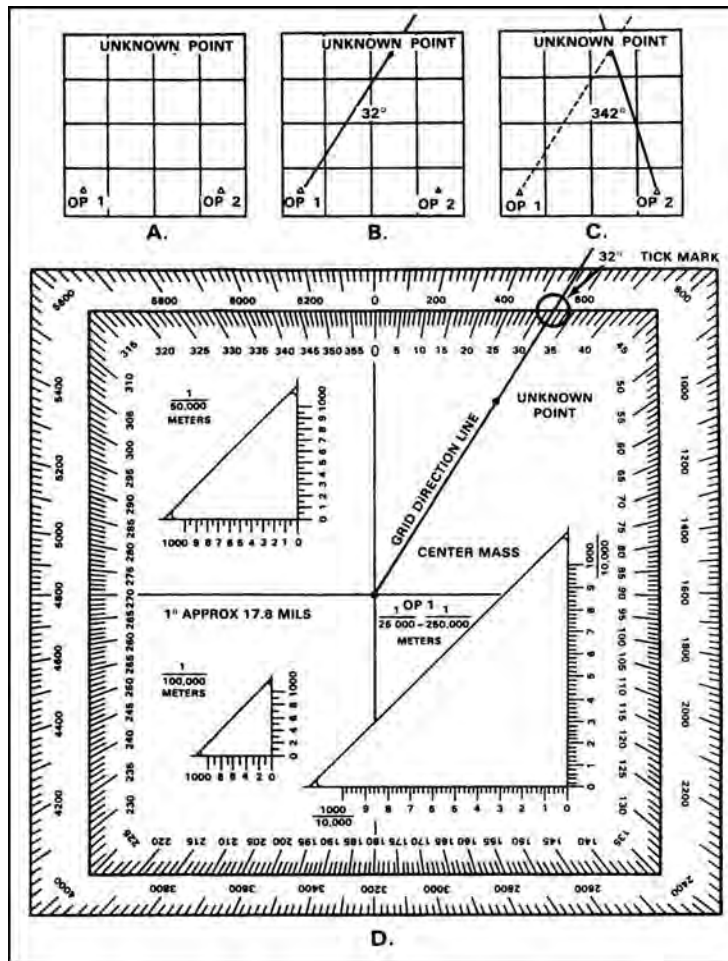


Figure C-35. Location of an unknown point

**Note.** The example map is not to scale—an easterly G-M angle to 10 degrees is used in the examples.

- a. Determine the G-M angle of the map you are using.
- b. Locate and mark your position on the map.

---

**Performance Steps**

---

c. Convert the magnetic azimuth to the unknown point (22 degrees); change it to a grid azimuth. In the example, the G-M angle used was 10 degrees easterly, giving a grid azimuth of 32 degrees.

d. Place the protractor on the map, ensuring that the zero-degree indication on the protractor is pointing to the top of the map (north) and the index point is placed center of mass on your location (figure C-36). Place a tick mark at the number of degrees you want to plot. Draw a line on the map from your position on this grid azimuth (32 degrees).

e. Move to or call a second known position from which the unknown point can be seen. Locate this position on the map.

f. Repeat steps 1c and 1d.

g. Where the lines cross is the location of the unknown point.

2. Use the straightedge method (when no compass is available) (figure C-36).

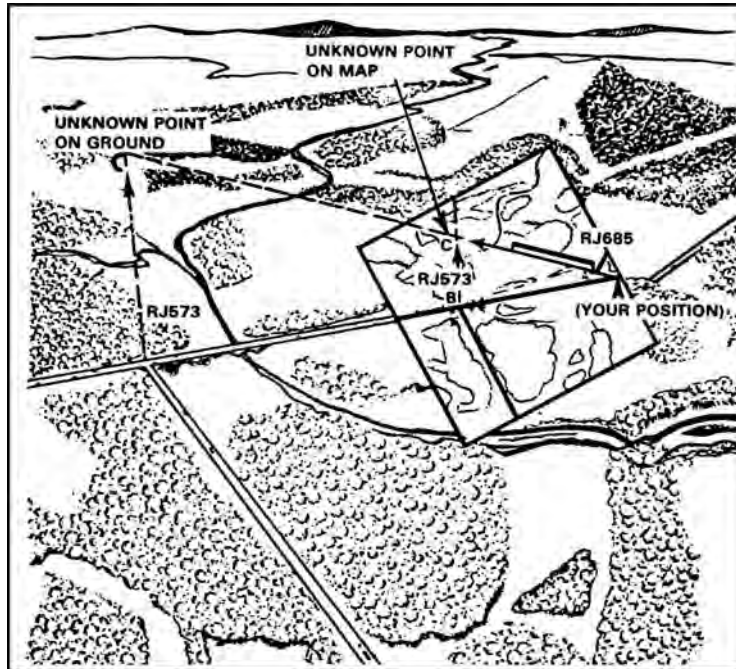


Figure C-36. Intersection without compass

---

---

**Performance Steps**

---

- a. See task number, 071-329-1012, Orient a Map to the Ground by Map Terrain Association.
  - b. Locate and mark your position on the map.
  - c. Lay a straightedge on the map with one end at user's position (A) as a pivot point, and rotate the straightedge until the unknown point is sighted along the edge.
  - d. Draw a line along the straightedge.
  - e. Repeat steps 2b, 2c, and 2d at position (B) and, to check for accuracy, at a third position.
  - f. The intersection of the lines is the location of the unknown point (C).
- 

**Evaluation Preparation:**

Setup: In a field location, give the soldier a standard 1:50,000-scale military map of the area, a compass, a straightedge, a coordinate scale, a protractor, a pencil, an unknown point, and two points (at least 400 meters apart) from which to determine azimuths to the unknown point.

*Brief Soldier:* Tell the soldier to determine the six-digit grid coordinates of the unknown point.

Performance Measures	GO	NO GO
1. Determined the six-digit grid coordinates, to include the 100,000 meter square identifier of the unknown point to within 100 meters.	_____	_____

**Evaluation Guidance:** Score the soldier GO if the performance measure is passed. Score the soldier NO GO if the performance measure is failed. If the soldier scores NO GO, show what was done wrong and how to do it correctly.

**References****Required**

FM 3-25.26

STP 21-1-SMCT

**Related**

---

**Land Navigation Task 13****Locate an Unknown Point on a Map and on the Ground by Resection**

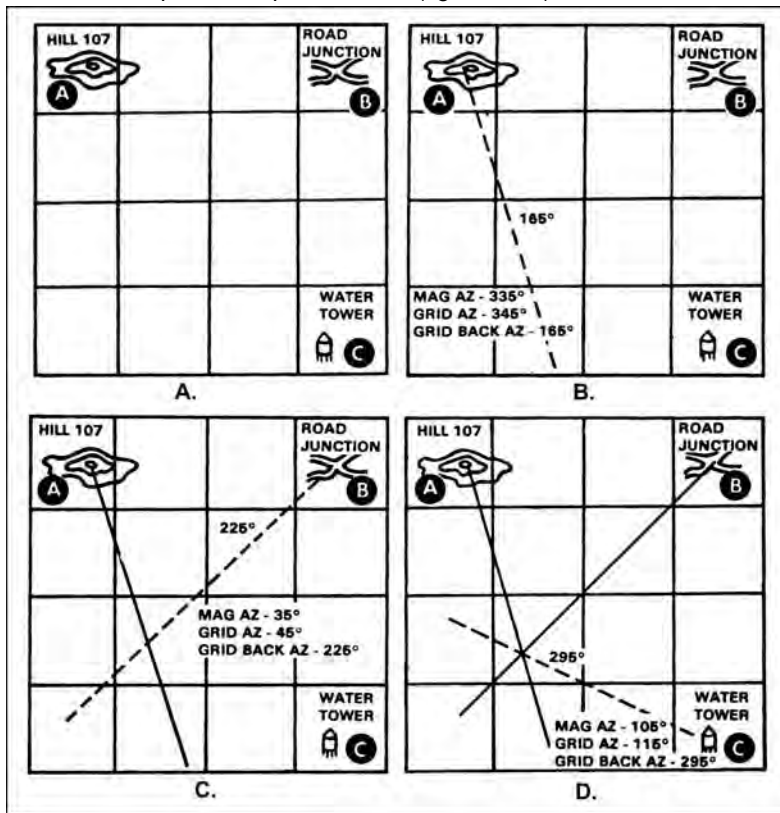
**Conditions:** Given an unknown location, a standard 1:50,000-scale military map of the area, a compass, a straightedge, a coordinate scale, a protractor

(GTA 05-02-012), a pencil, and two terrain features visible from your location and identifiable on the map.

**Standards:** Determined the 100,000 meter square identification letters and six-digit coordinates of your location to within 100 meters of the actual grid coordinates.

**Performance Steps**

1. Use the map and compass method (figure C-37).



**Figure C-37. Using the map and compass**

**Note.** The example map is not to scale—an easterly G-M angle of 10 degrees is used in the examples.

- a. Determine the G-M angle of the map you are using.

---

**Performance Steps**

---

b. Locate two known positions on the ground and mark them on your map (A, figure C-37).

c. Using your compass, measure the magnetic azimuth to one of the known locations; change it to a grid azimuth (B, figure C-37.)

(1) If it is a westerly G-M angle, subtract the number of degrees in the G-M angle from your magnetic azimuth.

(2) If it is an easterly G-M angle, add the number of degrees in the G-M angle to your magnetic azimuth.

d. Change this grid azimuth to a back azimuth.

e. Place the protractor on the map, ensuring that the zero degree indicator on the protractor is pointing to the top of the map (north), and the index point is placed center mass on this location. Place a tick mark at the number of degrees you want to plot. Remove the protractor from the map and draw a line on the map from this position on the grid back azimuth you found, in the direction of your unknown position.

f. Repeat steps 1c through 1e for a second (C, figure C-37), and third (D, figure C-37) known position.

g. Where these lines cross is your location.

2. Perform resection without a compass (figure C-38).

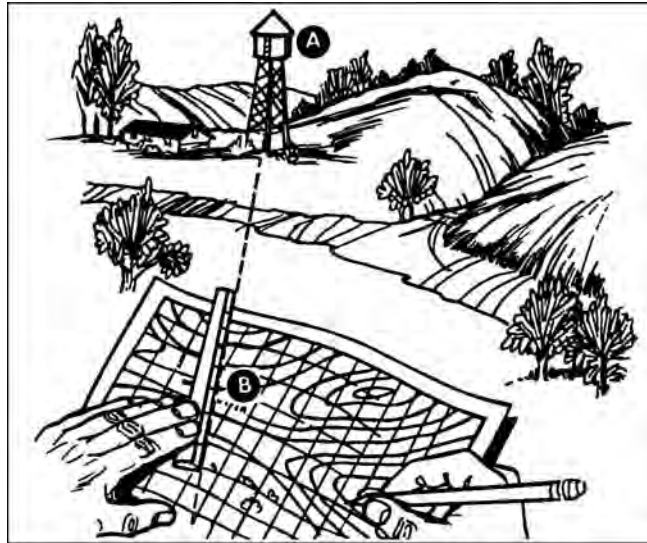


Figure C-38. Resection without a compass

---



---

**Performance Steps**

---

a. Orient your map as closely as you can using one of the ways you've learned about finding direction: compass, sun, watch, or stars. Then look for some feature, such a water tower (figure C-38, point A), that you can also find on the map. Put a ruler or straightedge on the map, and place its edge next to the water tower symbol (figure C-38, point B) on the map. Then align the straightedge so that it points directly at the real water tower. Draw a line along the straightedge or ruler (the line will cross the symbol for the water tower on your map).

**Note.** Do not move your map once it is properly oriented.

b. Find another feature, such a road junction (figure C-39, point C), and do the same things. Lay the straightedge on your map and point it at the real road junction, ensuring at the same time that its edge crosses over the road junction (figure C-39, point D) on the map. Draw another line along the ruler until it crosses (intersects) the first line. The point where the lines cross is your location. (figure C-39, point X) if you do this step with a third line, it may help location your position more accurately.



Figure C-39. Resection without a compass continued

---

---

**Performance Steps**

---

3. To perform modified resection you must be located on a linear feature such as a road, stream bank, railroad or ridge. First orient your map, then find some feature that you can also find on the map, such as the water tower in the previous example. Just as before, put a straightedge through the water tower on the map and align the straightedge so that it points directly at the real water tower. Draw a line along the ruler or straightedge. The point where the line crosses the linear feature is your location.

**Note.** Always orient your map as closely as you can. The compass is the best way to do so. If you don't have a ruler, use your rifle cleaning rod or a section of radio antenna as a straightedge.

---

**Evaluation Preparation:**

*Setup.* Give the soldier a standard 1:50,000-scale military map of the local area, a compass, a coordinate scale, a protractor (GTA 05-02-012), a pencil, a straightedge, and the location of two known points.

*Brief Soldier.* Tell the soldier to determine the six-digit coordinates for his location.

Performance Measures	GO	NO GO
1. Determined the six-digit grid coordinate and the 100,000 meter square identifier of the soldier's position (unknown point) within 100 meters.	—	—

**Evaluation Guidance:** Score the soldier GO if the performance measure is passed. Score the soldier NO GO if the performance measure is failed. If the soldier scores NO GO, show what was done wrong and how to do it correctly.

**References****Required**

FM 3-25.26

**Related**

---

**Land Navigation Task 14****Determine Direction without a Compass**

**Conditions:** During daylight and at night (with a clear view of the Big Dipper), given a wristwatch (not digital), the soldier must determine direction in a field environment with natural vegetation available.

**Standards:** Identified north and east within 15 degrees.

**Note.** All of the procedures given in this task give approximate directions. For accurate directions, a compass must be used.

**C-52**

---

**Performance Steps**

---

1. Determine direction using the shadow-tip method.
  - a. Place a stick or branch into the ground vertically at a fairly level spot where the sun will cast a distinct shadow. Mark the shadow with a stone, twig, or other means (figure C-40).

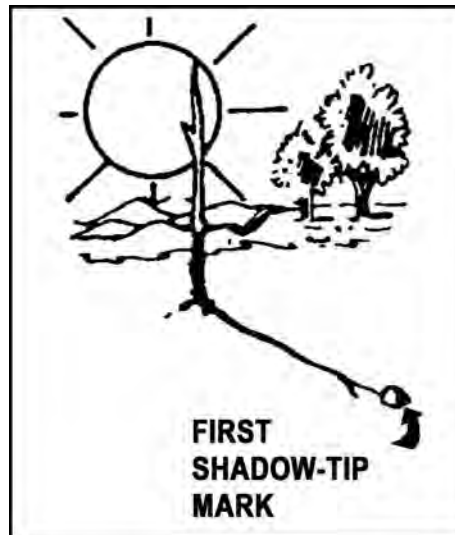


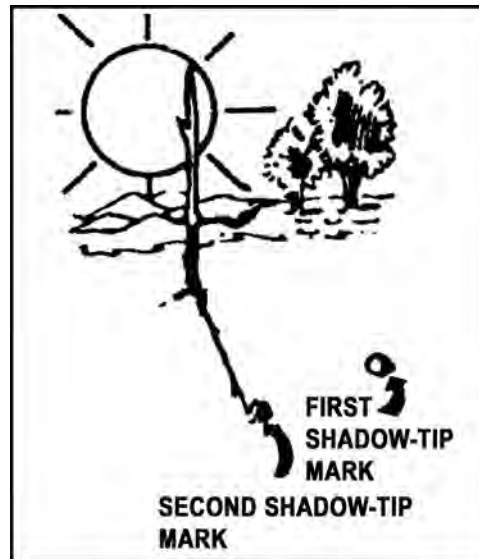
Figure C-40. First shadow-tip mark

- b. Wait 10 or 15 minutes until the shadow tip moves a few inches. Mark the new position of the shadow tip as in step 1a (figure C-41).
-

---

**Performance Steps**

---



**Figure C-41. Second shadow-tip mark**

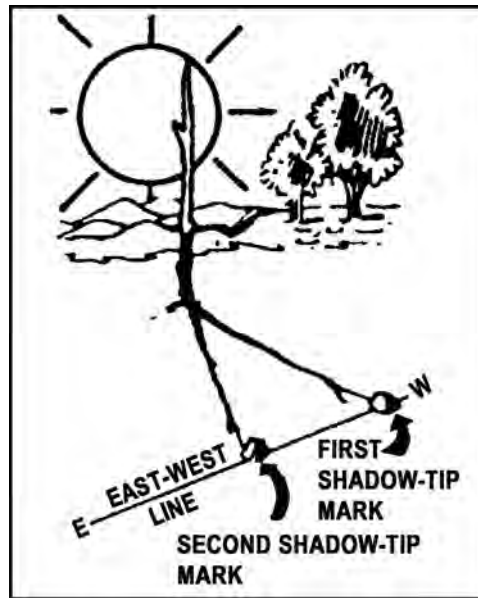
c. Draw a straight line through the two marks you made on the shadow tips. This line is an east-west line (figure C-42).

---

---

**Performance Steps**

---



**Figure C-42. East-west line**

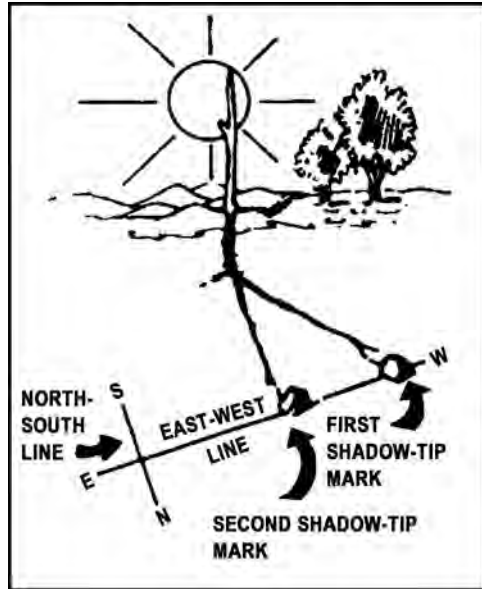
d. Determine which is the east end of the line and which is the west end.

- (1) The sun rises in the east and sets in the west.
- (2) The first shadow tip you mark is always west and the second mark is always east.
- (3) The shadow tip moves in the opposite direction.

e. Determine north and south. Draw a line at a right angle to the east-west line at any point (figure C-43). This is the north-south line.

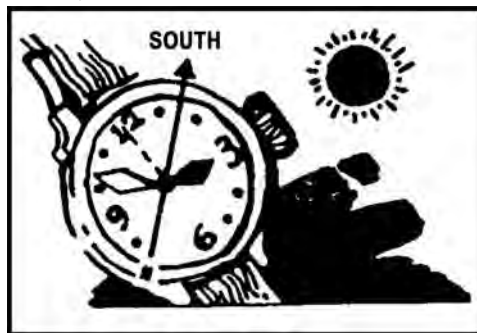
---

**Performance Steps**



**Figure C-43. North-south line**

2. Determine direction using the watch method without a compass.
  - a. Point the hour hand at the sun when you are north of the equator. South will be halfway between the hour hand and 12 o'clock (figure C-44).



**Figure C-44. Watch method**

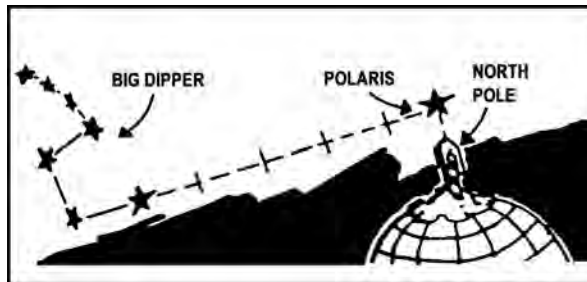
- b. Point 12 o'clock at the sun when you are south of the equator. North will be halfway between the hour hand and 12 o'clock.

---

**Performance Steps**

---

3. Use the North Star method to determine direction at night. At night, you can locate north by finding the North Star (Polaris). First, find the Big Dipper. The last two stars in the cup point directly at Polaris, which is about five times as far out as the distance between those two stars in the cup. Facing Polaris, you are looking north, with east on your right and west on your left (figure C-45).



**Figure C-45. North Star method**

**Note.** During the training session, stress these four facts:

1. The sun rises in the east and sets in the west.
2. When you face north, east is to your right, west is to your left, and south is to your back.
3. The Big Dipper is a pattern of stars that resembles a soup ladle.
4. The Southern Cross is the main constellation used as a guide south of the equator and the above general directions for using north and south stars are reversed.

---

**Evaluation Preparation:**

**Setup:** Directionally orient yourself to an area that is unfamiliar to the soldier to be tested.

**Brief Soldier:** Accompany the soldier to the area and tell the soldier to use the field-expedient methods to determine which direction is north and east. Use a compass direction of your choice. Do not tell the soldier how he or she did on performance measure 1 until he or she completes performance measure 2.

**Note.** Before the soldier is scored a GO for this task, he or she must display proficiency in all three field-expedient methods of determining direction without a compass. However, performance measure 3 must be tested in a different location.

<b>Performance Measures</b>	<b>GO</b>	<b>NO GO</b>
1. Determined direction using the shadow-tip field-expedient method	—	—
a. Placed a stick vertically into the ground at a desired spot.		
b. Marked the tip of the stick's shadow to represent west.		
c. Waited 10 to 15 minutes.		
d. Marked a new position of the tip of the stick's shadow to represent east.		
e. Drew an east-west line through the two shadow-tip marks.		
f. Drew a north-south line at a right angle to the east-west line.		
g. Pointed in the required direction within 15 degrees.		
2. Determined direction using the watch field-expedient method.	—	—
a. In the Northern Hemisphere, pointed the hour hand of the watch at the sun; in the Southern Hemisphere, pointed the 12 o'clock position of the watch at the sun.		
b. Pointed in the required direction within 15 degrees.		
3. Determined direction using the North Star field-expedient method.	—	—
a. Located the Big Dipper.		
b. Located Polaris, the North Star.		
c. Pointed in the required direction within 15 degrees.		

**Evaluation Guidance:** Score the soldier GO if all performance measures are passed. Score the soldier NO GO if any performance measure is failed. If the soldier scores NO GO, show the soldier what was done wrong and how to do it correctly.

**References**

**Required**

FM 3-25.26

**Related**



---

## Land Navigation Task 15

### Determine Azimuths Using a Protractor

**Conditions:** Given a standard 1:50,000-scale military map with two known points plotted on the map, a protractor, a straightedge, a pencil, and requirement to determine the azimuth from your location (point A) to another point (point B) on the map.

**Standards:** Determined the grid azimuth (in mils or degrees) from your location (point A) to point B to within 1 degree or 20 mils.

---

#### Performance Steps

---

1. The direction from one point to another, either on the map or on the ground, is called an azimuth. Azimuths are given in degrees or mils in a clockwise direction from north, and all azimuths taken from a map are grid azimuths.
  - a. An azimuth in degrees can be any number up to 360, as there are 360 degrees in a circle. Due east is 90 degrees, due south is 180 degrees, due west is 270 degrees, and due north is 360 degrees or 0 degrees.
  - b. An azimuth in mils can be any number up to 6400, as there are 6400 mils in circle. Due east is 1600 mils, due south is 3200 mils, due west is 4800 mils, and due north is 6400 mils or 0 mils.
2. The most accurate way to determine an azimuth from a map is to use a protractor. There are two types of protractors in use in the Army today.
  - a. The square protractor (GTA 05-02-012), which has a degree scale and a mil scale. The inner scale is the degree scale, and the outer scale is the mil scale.
  - b. The semicircular protractor, which may or may not have two scales: an outer scale in mils and an inner scale in degrees. The mil and degree scales consist of two rows of numbers. In each of the scales, the outer row of numbers is used when determining azimuths to the east of your position, and the inner row of numbers is used when determining azimuths to the west of your position.
3. Use the protractor properly.
  - a. Plot the location of two points on the map.
  - b. Using a straightedge, draw a straight line (azimuth line) from point A to point B.

**Note.** The line drawn between the two points must be long enough to cross the scale(s) of the protractor in order to read the azimuth. Should the line between the two points be too short to cross the scale(s), extend the line beyond point B until it crosses the scale(s).

---

---

**Performance Steps**

---

c. Place the index of the protractor at the point where the azimuths line crosses one of the vertical (north-south) grid lines. This procedure allows greater accuracy in aligning the index line to a true reading where the azimuth line crosses the protractor scale.

**Note.** Ensure that the 0-degrees or 0-mils mark on the protractor is toward the top (north) of the map.

d. Start at the 0-degree or 0-mil mark on the protractor and read to the right (clockwise) until you reach the point where the azimuth line crosses the scale(s) of the protractor.

**Note.** When using the protractor, each tick mark on the degree scale is 1 degree, while each tick mark on the mil scale is 20 mils.

e. Read the azimuth where the azimuth line crosses the scale(s).

(1) Figure 49, 65 degrees.

(2) Figure 50, 65 degrees - 1150 mils.

**Note.** When using the square protractor, the scale can be read all the way around the protractor. In using the semicircular protractor, when point B is to the left (west) of point A. The protractor must be reversed so that 0 is toward the bottom of the map (south).

---

**Evaluation Preparation:**

Setup: Provide the soldier with a 1:50,000-scale military map, two points plotted and labeled (A) and (B), a protractor, a straightedge, and a pencil.

*Brief Soldier.* Tell the soldier to determine the azimuth from point A to point B within one degree or 20 mils.

Performance Measures	GO	NO GO
1. Determined the correct azimuth (within 1 degree or 20 mils).	___	___

**Evaluation Guidance:** Score the soldier GO if the performance measure is passed. Score the soldier NO GO if the performance measure is failed. If the soldier scores NO GO, show what was done wrong and how to do it correctly.

**References****Required**

FM 3-25.26

GTA 05-02-012

**Related**

## Land Navigation Task 16

### Compute Back Azimuths

**Conditions:** Given azimuths and a requirement to compute back azimuths.

**Standards:** Determined the back azimuth of a given azimuth to the exact degree or mils.

#### Performance Steps

1. Determine a back azimuth using degrees. Suppose you follow a 65-degree azimuth from point A to point B and then want to go back to your original location. To do this, you use a back azimuth. You simply add 180 to the first azimuth. Your back azimuth is  $65 + 180 = 245$  degrees.
2. Determine a back azimuth using mils. You move from point A to point B on an azimuth of 1150 mils. Should you wish to return to point A, you would follow a back azimuth. To determine the back azimuth you simply add 3200 mils to 1150:  $3200 + 1150 = 4350$ .

**Note.** The rule to remember to determine a back azimuth is as follows:

- Degrees: Less than 180 degrees, add 180 degrees. More than 180 degrees, subtract 180 degrees.
- Mils: Less than 3200 mils, add 3200 mils. More than 3200 mils, subtract 3200 mils.

#### Evaluation Preparation:

*Setup:* Provide the soldier with azimuths, one in degrees and one in mils.

*Brief Soldier:* Tell the soldier to compute the exact back azimuths.

Performance Measures	GO	NO GO
1. Computed the exact back azimuth.	___	___

**Evaluation Guidance:** Score the soldier GO if the performance measure is passed. Score the soldier NO GO if the performance measure is failed. If the soldier scores NO GO, show what was done wrong and how to do it correctly.

#### References

##### Required

FM 3-25.26

##### Related



## Glossary

ACS	Army Community Service
ADAPCP	Alcohol and Drug Abuse Prevention and Control Program
AER	Army Emergency Relief
AFTB	Army Family Team Building
AHS	Academy of Health Sciences
AIDS	acquired immunodeficiency syndrome
APAC	Army Public Affairs Center
APC	armored personnel carrier
AR	Army regulation
ATNAA	antidote treatment nerve agent autoinjector
AZ	azimuth
BDU	battle dress uniform
BFV	Bradley fighting vehicle
BMD	Boyevaya Mashina Desantnika [literal Russian: combat vehicle, airborne]
BMP	Boyevaya Mashina Pekhoty [literal Russian: combat vehicle, infantry]
C2W	command and control warfare
CANA	convulsant antidote for nerve agent
CASCOM	Combined Arms Support Command
CB	chemical or biological
CCC	Community Counseling Center
CID	Criminal Investigation Command
CLP	cleaner lubricant preservative
cm	centimeter
CO	company
CTT	Common Task Test
CVC	combat vehicle crewman
D	drive
DA CIR	Department of the Army circular
DA Form	Department of the Army form
DA Pam	Department of the Army pamphlet

DD Form	Department of Defense form
DNA	deoxyribonucleic acid
DNVT	digital non-secure voice terminal
DODD	Department of Defense directive
DODI	Department of Defense instruction
DS2	decontaminating solution #2
DU	depleted uranium
EFMP	Exceptional Family Members Program
EO	equal opportunity
FEBA	forward edge of the battle area
FM	field manual
FPL	final protective line
FSN	Federal stock number
FTX	field training exercise
G2	assistant chief of staff, G2 (intelligence)
G3	assistant chief of staff, G3 (operations and plans)
G-M	grid-magnetic
GMD	grease, molybdenum disulfide
GPS	Global Positioning System
GTA	graphic training aid
HC	hexachloroethane (smoke)
HIV	human immunodeficiency virus
HMMWV	high mobility multipurpose wheeled vehicle
HQ	headquarters
HUMINT	human intelligence
ID	Identification
IDAA	Individual Dynamic Absorption Application
IHFR	improved high frequency radio
IMINT	imagery intelligence
IN	Infantry
JAG	Judge Advocate General
JFK	John F Kennedy Special Warfare Center and School
JP	joint publication

**Glossary-2**

LAW	lubricating oil arctic weather
LBE	load-bearing equipment
LCE	load carrying equipment
LCSS	lightweight camouflage screen system
LCE	load carrying equipment
LSA	lubricating oil, semifluid, automatic
LSAT	(lubricating oil)
m	meter
MANSCEN	Maneuver Support Center
MASINT	measurement and signature intelligence
METT-TC	mission, enemy, terrain, troops, time available, and civilian considerations
MI	military intelligence
mm	millimeter
MOPP	mission-oriented protective posture
MOUT	military operations in urban terrain
mph	miles per hour
N	neutral
NATO	North Atlantic Treaty Organization
NBC	nuclear, biological, and chemical
NCO	noncommissioned officer
NCOIC	noncommissioned officer in charge
NCS	net control station
NSN	national stock number
OD	olive drab
OPLAN	operation plan
OPORD	operation order
OPSEC	operations security
P	park
Pam Cl	pralidoxime chloride
PDF	principal direction of fire
PL	preservative lubricant
PLT	platoon
PMCS	preventive maintenance checks and services
PMM	preventive medicine measure

RADIAC	radiation, detection, indication, and computation
RBC	rifle bore cleaner
ROC-V	recognition of combat vehicles
RSTA	reconnaissance, surveillance, and target acquisition
RT	radio transmission
S1	personnel officer
S2	intelligence officer
SALUTE	size, activity, location, unit, time, equipment
SAW	squad automatic weapon
SIG	signal
SIGINT	signals intelligence
SINGARS	Single-Channel Ground and Airborne Radio System
SL	skill level
SMCT	soldier's manual of common tasks
SME	subject matter expert
SOI	signal operating instruction
SOP	standing operating procedure
SQD	squad
SSI	Soldier Support Institute
STD	sexually transmitted disease
STP	soldier training publication
T&E	traversing and elevating
TB	technical bulletin
TC	training circular
TEC	training extension course
TM	technical manual
TRP	target reference point
TW	target width
TWS	thermal weapon sight



U.S.	United States
UCMJ	Uniform Code of Military Justice
VRC	vehicular radio configuration
WBGT	wet bulb globe temperature
WP	white phosphorus



## References

### Required Publications

Required publications are sources that users must read in order to understand or to comply with this publication.

---

#### Army Regulations

- AR 15-6, *Procedures for Investigating Officers and Boards of Officers* (CH1, 30 September 1996), 11 May 1988.
- AR 350-30, *Code of Conduct/Survival, Evasion, Resistance and Escape (SERE) Training*, 10 December 1985.
- AR 360-1(AR 360-5/AR 360-81), *The Army Public Affairs Program*, 15 September 2000.
- AR 530-1, *Operations Security (OPSEC)*, 3 March 1995.
- AR 600-13, *Army Policy for the Assignment of Female Soldiers*, 27 March 1992.
- AR 600-20, *Army Command Policy*, 13 May 2002.
- AR 635-200, *Enlisted Personnel*, 1 November 2000.

#### Department of Army Forms

- DA Form 1594, *Daily Staff Journal or Duty Officer's Log*
- DA Form 2404, *Equipment Inspection and Maintenance Worksheet*
- DA Form 5304-R, *Family Care Plan Counseling Checklist*
- DA Form 5305-R, *Family Care Plan*
- DA Form 5517-R, *Standard Range Card*

#### Department of Army Pamphlets

- DA PAM 350-20, *Unit Equal Opportunity Training Guide*, (CH1, 1 June 1994), 30 August 1993.
- DA PAM 600-26, *Department of the Army Affirmative Action Plan*, 23 May 1990.

#### Department of Defense Publications

- DODD 7050.6, *Military Whistleblower Protection*, 23 June 2000.

#### Devices

- DVC 08-15

#### Field Manuals

- FM 3-0 (FM 100-5), *Operations*, 14 June 2001.
- FM 3-05.71 (FM 21-78), *Resistance and Escape (U)*, 7 September 2001.

FM 3-3, *Chemical and Biological Contamination Avoidance*, (CH1, 29 September 1994) 16 November 1992.

FM 3-3-1, *Nuclear Contamination Avoidance*, 9 September 1994.

FM 3-4, *NBC Protection*, (CH2, 21 February 1996), 29 May 1992.

FM 3-5, *NBC Decontamination*, (CH1, 31 January 2002), 28 July 2000.  
Will be revised as FM 3-11.5.

FM 3-22.68 (FM 23-14/FM 23-67), *Crew-Served Machine Guns, 5.56-MM and 7.62-MM*, 31 January 2003.

FM 3-22.9, *Rifle Marksmanship M16A1, M16A2/3, M16A4 and M4 Carbine*, 24 April 2003.

FM 3-25.26 (FM 21-26), *Map Reading and Land Navigation*, 20 July 2001.

FM 7-8, *Infantry Rifle Platoon and Squad*, (CH1, 1 March 2001), 22 April 1992. Will be revised as FM 3-21.8.

FM 21-16, *Unexploded Ordnance (UXO) Procedures*, 30 August 1994. Will be revised as FM 4-30.11.

FM 21-75, *Combat Skills of the Soldier*, 3 August 1984. Will be revised as FM 3-21.75.

FM 21-305, *Manual for the Wheeled Vehicle Driver*, 27 August 1993.

FM 23-23, *Antipersonnel Mine M18A1 and M18 (CLAYMORE)*, (CH2, 30 March 1973), 6 January 1966. Will be revised as FM 3-22.23.

FM 24-18, *Tactical Single-Channel Radio Communications Techniques*, 30 September 1987.

FM 34-1, *Intelligence and Electronic Warfare Operations*, 27 September 1994. Will be revised as FM 2-0.

FM 34-60, *Counterintelligence*, 3 October 1995. Will be revised as FM 2-01.2. Will be revised as FM 2-01.2

FM 46-1, *Public Affairs Operations*, 30 May 1997.

FM 55-30, *Army Motor Transport Units and Operations*, (CH1, 15 September 1999), 27 June 1997. Will be revised as FM 4-01.40.

#### **Graphic Training Aids**

GTA 03-04-001A, *Depleted Uranium Awareness*, 1 October 1999.

GTA 05-02-012, *Coordinate Scale and Protractor (simple device)*, 2 January 1981.

GTA 09-12-001, *Unexploded Ordnance (UXO) Procedures*, 3 January 1992.

#### **References-2**

### **Joint Publications**

JP 4-06, *Joint Tactics, Techniques, and Procedures for Mortuary Affairs in Joint Operations*, 28 August 1996.

### **Other Product Types**

ACP 125 US SUPPL-1, *Communications Instructions Radiotelephone Procedures for Use by United States Ground Forces*, 1 October 1985.  
ACP 125(E), *Communication Instructions—Radiotelephone Procedures*, 1 August 1987.  
MANUAL-MCM, *Manual for Courts-Martial, United States, 2000 Edition*, 21 July 2000.

### **Soldier Training Publications**

STP 21-1-SMCT, *Soldier's Manual of Common Tasks Skill Level 1*, 31 August 2003.

### **Technical Manuals**

TM 3-4230-229-10, *Operator's Manual for Decontaminating Kit, Skin: M291*, (NSN 4230-01-251-8702), (CH1, 28 February 1991), 2 October 1989.  
TM 3-4230-235-10, *Operator's Manual for Decontamination Kit, Individual Equipment: M295* (NSN 6850-01-357-8456), (CH1, 8 June 1994), 20 February 1994.  
TM 3-4240-279-10, *Operator's Manual for Mask, Chemical-Biological: Field, ABC-M17* (NSN 4240-00-542-4450) *Small*; (4240-00-542-4451) *Medium*; (4240-00-542-4452) *Large*; M17A1 (4240-00-926-4199) *Small*; (4240-00-926-4201) *Medium*; (4240-00-926-4200) *LARGE*; M17A2 (4240-01-143-2017) *X-Small*; (4240-01-143-2018) *Small*; (4240-01-143-2019) *Medium*; (4240-01-143-2020) *Large*, (CH3, 9 May 1997), 5 October 1987.  
TM 3-4240-280-10, *Operator's Manual for Mask, Chemical-Biological: Aircraft, ABC-M24 And Accessories AND Mask, Chemical-Biological, Tank, M25A1 and Accessories*, (CH3, 9 May 1997), 15 March 1988.  
TM 3-4240-346-10, *Operator's Manual for Chemical-Biological Mask: Field, M40A1* (NSN 4240-01-370-3821-*Small*) (4240-01-370-3822-*Medium*) (4240-01-370-3823-*Large*); *Chemical-Biological Mask: Combat Vehicle, M42A2* (4240-01-4100-*Small*) (4240-01-413-4101-*Medium*) (4240-01-413-4102-*Large*), (CH1, 15 March 2002), 1 August 1998.

- TM 3-4240-348-10, *Operator Instructions for Mask, Chemical-Biological: Land Warrior, M45 (NSN 4240-01-447-6989 - Extra Small); (4240-01-447-6987 - Small); (4240-01-447-8967 - Medium); and (4240-01-447-6988 - Large)*, 21 January 2000.
- TM 3-6665-307-10, *Operator's Manual for Chemical Agent Detector Kit, M256 (NSN 6665-01-016-8399) and M256A1 (6665-01-133-4964)*, (CH3, 15 April 1998), 1 September 1985.
- TM 3-6665-311-10, *Operator's Manual for Paper, Chemical Agent Detector: M9 (NSN 6665-01-226-5589)*, 31 August 1998.
- TM 9-1005-201-10, *Operator's Manual for Machine Gun, 5.56-MM, M249 w/Equip (NSN 1005-01-127-7510) (EIC: 4BG)*, (CH2, 28 June 2000), 26 July 1991.
- TM 9-1005-224-10, *Operator's Manual for Machine Gun, 7.62-MM, M60 w/E (NSN 1005-00-605-7710) (EIC: 4AJ) and Machine Gun, 7.62-MM, M60D w/E (1005-00-909-3002) (EIC: 4A8)*, 2 April 1998.
- TM 9-1005-224-23&P, *Unit and Direct Maintenance Manual (Including Repair Parts and Special Tools List) for Machine Gun, 7.62-MM, M60 w/E (NSN 1005-00-605-7710) (EIC: 4AJ) and Machine Gun, 7.62-MM, M60D w/E (1005-00-090-3002) (EIC: 4A8)*, 21 May 1998.
- TM 9-1005-249-10, *Operator's Manual for Rifle, 5.56-MM, M16 (NSN 1005-00-856-6885) Rifle, 5.56-MM, M16A1 (1005-00-073-9421)*, (CH2, 11 May 1990), 11 February 1985.
- TM 9-1330-200-12, *Operator's and Organizational Maintenance Manual for Grenades*, (CH17, 15 March 2002), 17 September 1971.
- TM 11-5820-401-10-2, *Operator's Manual for Radio Sets, AN/VRC-12 (NSN 5820-00-223-7412) (EIC: GCC) AN/VRC-43 (5820-00-223-7415) (EIC: GCD) AN/VRC-44 (5820-00-223-7417) (EIC: GCE) AN/VRC-45 (5820-00-223-7418) (EIC: GCF) AN/VRC-46 (5820-00-223-7433) (EIC: GCG) AN/VRC-47 (5820-00-223-7434) (EIC: GCH) AN/VRC-48 (5820-00-223-7435) (EIC: GCH) AN/VRC-49*, (CH2, 15 August 1995), 23 November 1982.
- TM 11-5820-890-10-8, *Operator's Manual for SINCGARS Ground Combat Net Radio, ICOM Manpack Radio, AN/PRC-119A (NSN 5820-01-267-9482) (EIC: L2Q), Short Range Vehicular Radio AN/VRC-87A (5820-01-267-9480) (EIC: L22), Short Range Vehicular Radio with Single Radio Mount AN/VRC-87C (5820-01-304-2045) (EIC: GDC), Short Range Vehicular Radio with Dismount AN/VRC-88A (5820-01-267-9481) (EIC: L23), Short Range/Long Range Vehicular Radio AN/VRC-89A (5820-01-267-9479) (EIC: L24), Long Range Vehicular Radio AN/VRC-90A (5820-01-268-5105) (EIC: L25)*,

#### References-4

*Short Range/Long Range Vehicular Radio with Dismount AN/VRC-91A (5820-01-267-9478) (EIC: L26), Short Range/Long Range Vehicular Radio AN/VRC-92A (5820-01-267-9477) (EIC: L27) Used with Automated Net Control Device (ANCD) (AN/CYZ-10) Precision Lightweight GPS Receiver (PLGR) (AN/PSN-11) Secure Telephone Unit (STU) Frequency Hopping Multiplexer (FHMUX), 1 December 1998.*

#### **Training Circulars**

- TC 19-138, *Civilian Law Enforcement and Security Officer Training*, 1 August 2001.
- TC 26-6, *Commander's Equal Opportunity Handbook*, 14 October 1994.

#### **Related Publications**

Related publications are sources of additional information. They are not required in order to understand this publication.

#### **Army Regulations**

- AR 27-3, *The Army Legal Assistance Program*, (CH2, 21 February 1996), 30 September 1992.
- AR 50-5, *Nuclear and Chemical Weapons and Material – Nuclear Surety*, 1 August 2000.
- AR 600-8-1, *Army Casualty Operations/Assistance/Insurance*, 20 October 1994.
- AR 600-20, *Army Command Policy*, 13 May 2002.
- AR 600-63, *Army Health Promotion*, (CH1, 28 April 1996) 17 November 1987.
- AR 608-18, *The Army Family Advocacy Program*, 1 September 1995.
- AR 608-99, *Family Support, Child Custody, and Paternity*, 1 November 1994.
- AR 670-1, *Wear and Appearance of Army Uniforms and Insignia*, 1 July 2002.

#### **Department of Army Pamphlets**

- DA PAM 608-47, *A Guide to Establishing Family Support Groups*, 16 August 1993.
- DA PAM 738-750, *Functional Users Manual for the Army Maintenance Management System (TAMMS)*, 1 August 1994.

### **Department of Defense Publications**

DODD 1300.7, *Training and Education to Support the Code of Conduct (CoC)*, 8 December 2000.

### **Devices**

DVC 08-36 Kit, *Nerve Agent Antidote Mark-1*

DVC 08-37, *Convulsant Nerve Agent TR*

### **Field Manuals**

FM 3-21.7, (FM 7-7), *The Mechanized Infantry Platoon and Squad (APC)*, 20 August 2002.

FM 3-21.71 (FM 7-7J), *Mechanized Infantry Platoon and Squad (Bradley)*, 20 August 2002.

FM 3-22.31 (FM 23-31), *40-mm Grenade Launchers, M203 and M79*, 13 February 2003.

FM 3-23.24, *47 Dragon Medium Antitank Weapon System*, 30 August 2001.

FM 3-23.25, *Light Antiarmy Weapons*, 30 August 2001.

FM 3-90.1 (FM 71-1), *Tank and Mechanized Infantry Company Team*, 9 December 2002.

FM 4-25.11 (FM 21-11), *First Aid*, 23 December 2002.

FM 8-285, *Treatment of Chemical Agent Casualties and Conventional Military Chemical Injuries*, 22 December 1995. Will be revised as FM 4-02.285.

FM 19-15, *Civil Disturbances*, 25 November 1985. Will be revised as FM 3-19.15.

FM 20-3, *Camouflage, Concealment, and Decoys*, 20 August 1999. Will be revised as FM 3-58.1.

FM 20-32, *Mine/Countermine Operations*, (CH3, 1 October 2002), 29 May 1998. Will be revised as FM 3-34.32.

FM 21-10, *Field Hygiene and Sanitation*, 21 June 2000. Will be revised as FM 4-25.10.

FM 22-6, *Guard Duty*, (CH1, 15 January 1975), 17 September 1971. Will be revised as FM 3-21.6.

FM 23-27, *MK 19, 40-MM Grenade Machine Gun, MOD 3*, 27 December 1988. Will be revised as FM 3-22.27.

FM 23-35, *Combat Training with Pistols and Revolvers*, 3 October 1988. Will be revised as FM 3-23.35.

### **References-6**



FM 23-65, *Browning Machine Gun, Caliber .50 HB, M2*, (CH1, 12 September 2001), 19 June 1991. Will be revised as FM 3-22.65.  
FM 24-19, *Radio Operator's Handbook*, 24 May 1991.  
FM 27-10, *The Law of Land Warfare*, 18 July 1956 with change 1, 15 July 1976  
FM 90-3, *Desert Operations*, 24 August 1993.

#### **Graphic Training Aids**

GTA 05-10-044, *Mine Awareness*, 1 May 1999.  
GTA 17-02-011, *Combat Vehicle Identification*, 3 January 1984.  
GTA 17-02-013, *Armored Vehicle Recognition*, 1 May 1987.

#### **Other Product Types**

USERS GUIDE-AFTB, *Army Family Team Building Level I Guide*, 12 December 1996

---

#### **Technical Bulletins**

TB 9-1300-278, *Guidelines for Safe Response to Handling, Storage, and Transportation Accidents Involving Army Tank Munitions or Armor Which Contain Depleted Uranium*, (CH1, 23 February 2001), 21 July 1996.

#### **Technical Manuals**

TM 3-4240-300-10-2, *Operator's Manual for Chemical-Biological Mask: Combat Vehicle, M42 (NSN 4240-01-258-0064) Small, (4240-01-258-0065) Medium, (4240-01-258-0066) Large*, (CH3, 31 July 1992), 30 August 1988.  
TM 9-1005-213-10, *Operator's Manual for Machine Guns, Caliber .50; M2, Heavy Barrel Flexible, w/E (NSN 1005-00-322-9715) (EIC: 4AG) M48 Turret Type (1005-00-957-3893) (EIC: 4BB) Soft Mount (1005-01-343-0747) (Navy) Fixed Type Right Hand Feed (1005-00-122-9339) (Navy) Fixed Type Left Hand Feed*, 1 June 2001.  
TM 9-1005-313-10, *Operator's Manual for Machine Gun, 7.62MM, M240 (NSN 1005-01-025-8095) M240B (1005-01-412-3129) M240C (1005-01-085-4758) M240D (1005-01-418-6995) M240E1 (1005-01-252-4288) M240G (1005-01-359-2714) M240N (1005-01-493-1666)*, 15 November 2002.

- TM 9-1005-317-10, *Operator's Manual for Pistol, Semiautomatic, 9MM, M9 (NSN 1005-01-118-2640)*, (CH3, 14 December 1990), 31 July 1985.
- TM 9-1005-319-10, *Operator's Manual for Rifle, 5.56 MM, M16A2 w/E (NSN 1005-01-128-9936) (EIC: 4GM); Rifle, 5.56 MM, M16A3 (1005-01-357-5112); Rifle, 5.56 MM, M16A4 (1005-01-383-2872) (EIC: 4F9); Carbine, 5.56 MM, M4 w/E (1005-01-231-0973) (EIC: 4FJ); Carbine, 5.56 MM, M4A1 (1005-01-382-0953) (EIC: 4GC)*, 1 October 1998.
- TM 9-1010-221-10, *Operator's Manual for Grenade Launcher, 40-MM: M203 (NSN 1010-00-179-6447); Grenade Launcher, 40-MM: M203A1 (1010-01-434-9028); Headquarters, Department of the Army, Air Force, Marine Corps, And Navy*, 1 August 2001.
- TM 9-1010-230-10, *Operator's Manual for Machine Gun, 40-MM, MK 19, MOD 3 (NSN 1010-01-126-9063) (EIC: 4AE)*, 30 May 2001.
- TM 9-1315-886-12, *Operator's and Unit Maintenance Manual for Launcher and Cartridge, 84 Millimeter: M136 (AT4)*, (CH4, 14 March 2001), 15 May 1990.
- TM 11-5855-213-10, *Operator's Manual for Night Vision Sight, Individual Served Weapon, AN/PVS-4 (NSN 5855-00-629-5334) (EIC: IPJ)*, (CH1, 15 June 1993), 1 February 1993.
- TM 11-5855-309-12&P, *Operator's and Unit Maintenance Manual (Including Repair Parts and Special Tools List)*

#### **Training Circulars**

- TC 20-32-5, *Commander's Reference Guide for Land Mine and Explosive Hazards (Iraq)*, 13 February 2003.

#### **TRADOC Pamphlets**

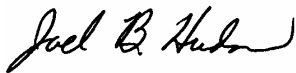
- TRADOC PAM 600-4, *IET Soldier's Handbook*, 1 April 2001.

**STP 21-1-SMCT  
31 AUGUST 2003**

By Order of the Secretary of the Army:

**PETER J. SCHOOMAKER**  
General, United States Army  
Chief of Staff

Official:



**JOEL B. HUDSON**  
Administrative Assistant to the  
Secretary of the Army  
0321002

DISTRIBUTION:

*Active Army, Army National Guard, and US Army Reserve:* Distribute in accordance with the initial distribution number IDN 11 1447, requirements for STP 21-1-SMCT.



**PIN: 059832-000**



PIN: 059832-000